

00071

CX-QUINSAM 78A

Part 2

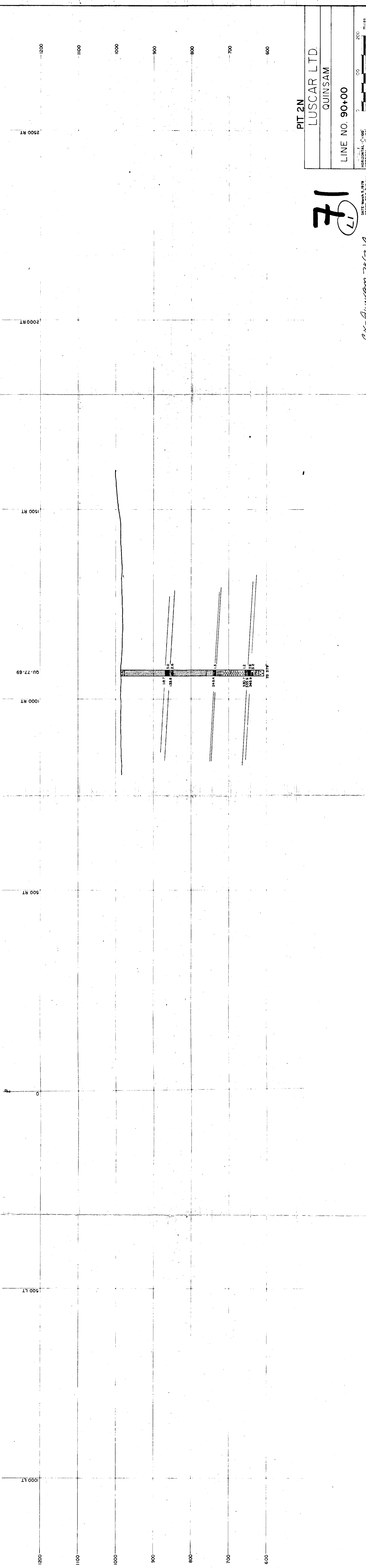

PIT 2N
 LUSCAR LTD.
 QUINSAM
 LINE NO. 90+00

71
 LI

HORIZONTAL: 1" = 100'
 VERTICAL: 1" = 100'

DATE: March 5, 1979
 DRAWN BY: D. Palmer

EX-Quinsam 78 (2) A

0 100 200
 feet

QSG 236/PH23

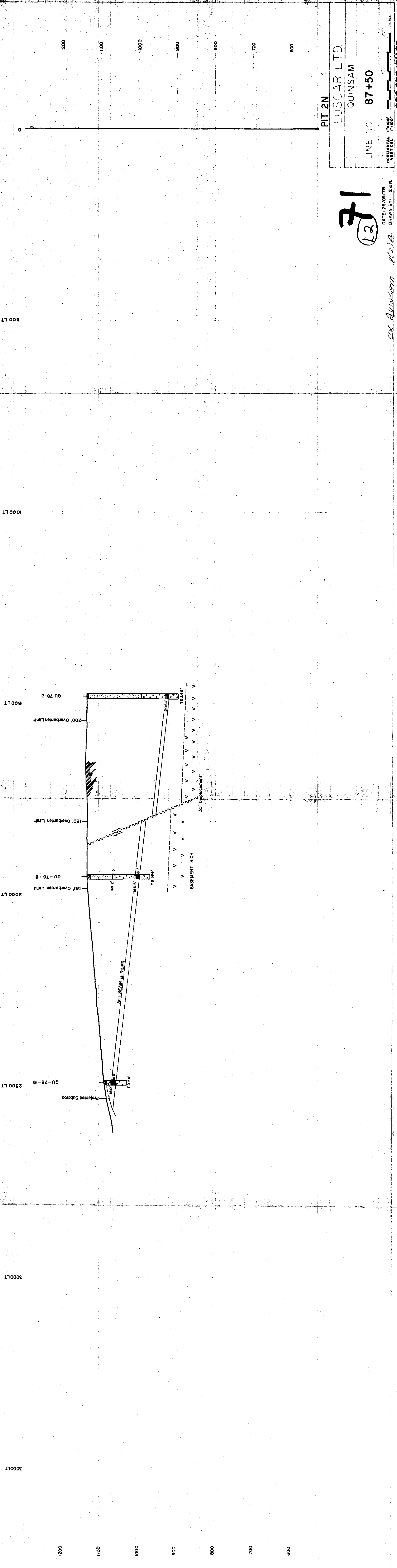

PIT 2N

LUSCAR LTD.
QUINSAM

LINE NO 87+50

71
①②

DATE: 25/05/78
DRAWN BY: S.J.N.
EX-Quinsam - RZA

QSG 235/PH 23

PIT 2N
 LUSCAR LTD
 QUINSAM
 LINE NO 80+00

71
 (L3)

DATE: 25/05/78
 DRAWN BY: J. N.
 EX: AUNSON

HORIZONTAL 1"=100'
 VERTICAL 1"=100'
 QSG 232/PH 23

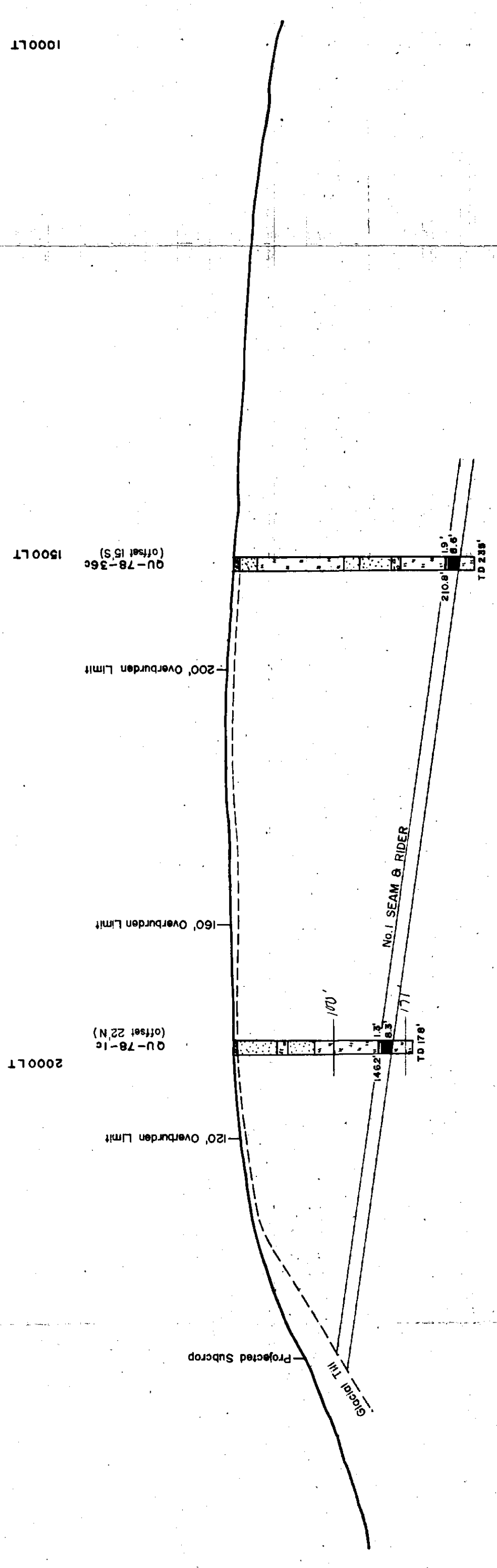

0 200 400
SCALE
HORIZONTAL 1" = 100'
VERTICAL 1" = 100'

DATE: 25/05/78
DRAWN BY: S.J.N.

EX - QUINSAM 78 (2) A

71
L4

LINE NO. 77+50

QUINSAM

LUSCAR LTD.

PIT 2N

QSG 231/PH23

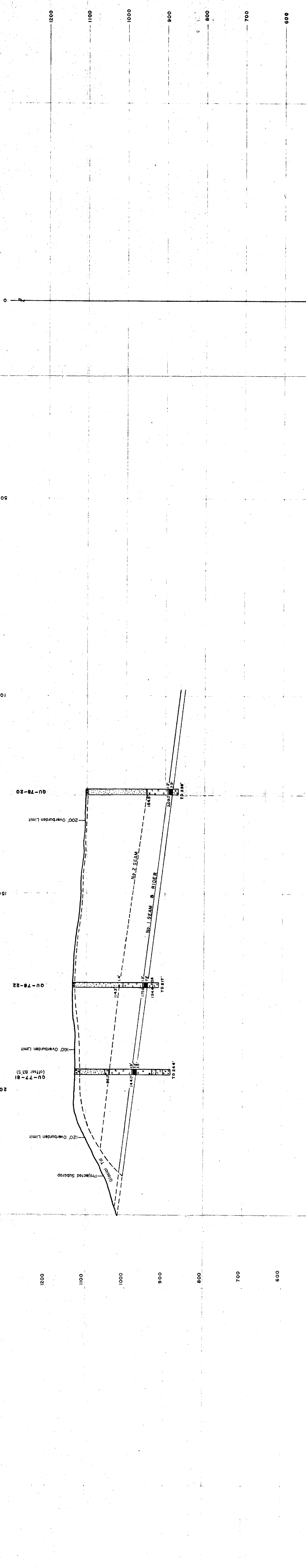

PIT 2N
 LUSCAR LTD.
 QUINSAM
 LINE NO. 72+50

71
 LS

DATE: 25/05/78
 DRAWN BY: S.J.N.

EX-QUINSAM 78(2)A

HORIZONTAL SCALE: 1" = 100'
 VERTICAL SCALE: 1" = 20'
 QSG 229/PH 23

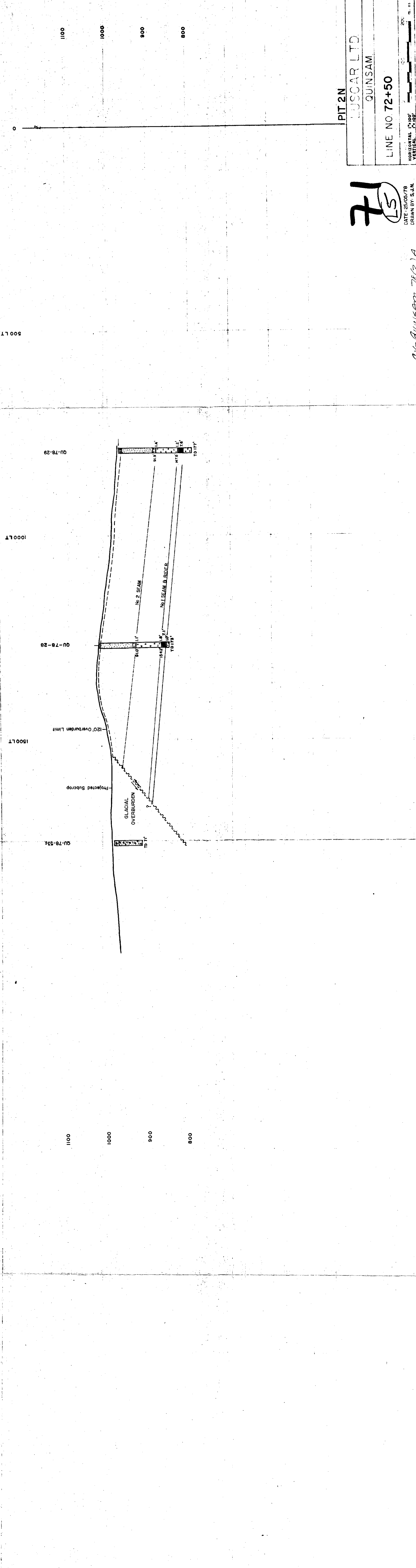

3500 LT 3000 LT 2500 LT 2000 LT 1500 LT 1000 LT 500 LT

1500 LT 1000 LT 500 LT

QU-78-32 QU-78-33
(offset 10 S)

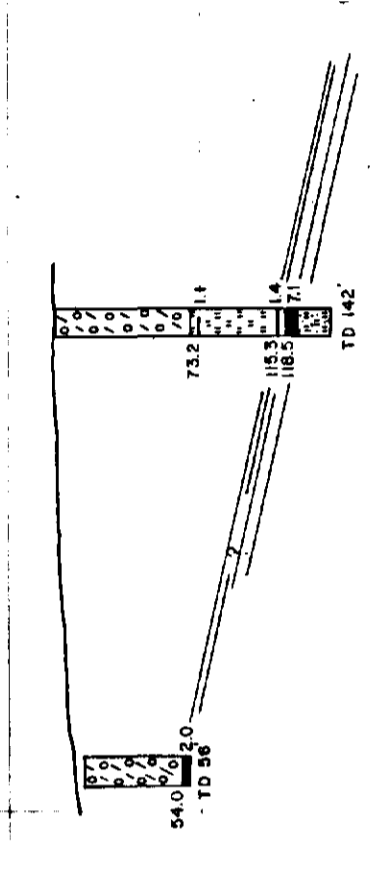

PIT 2 N
LUSCAR LTD.
QUINSAM
LINE NO. 70+00

71
L6

DATE: March 2, 1979
DRAWN BY: S. Palmer
SCALE:
HORIZONTAL: 1" = 100'
VERTICAL: 1" = 100'
0' 50' 100' 200' miles

EX-QUINSAM 70 (2) A

QSG 228/PH 23

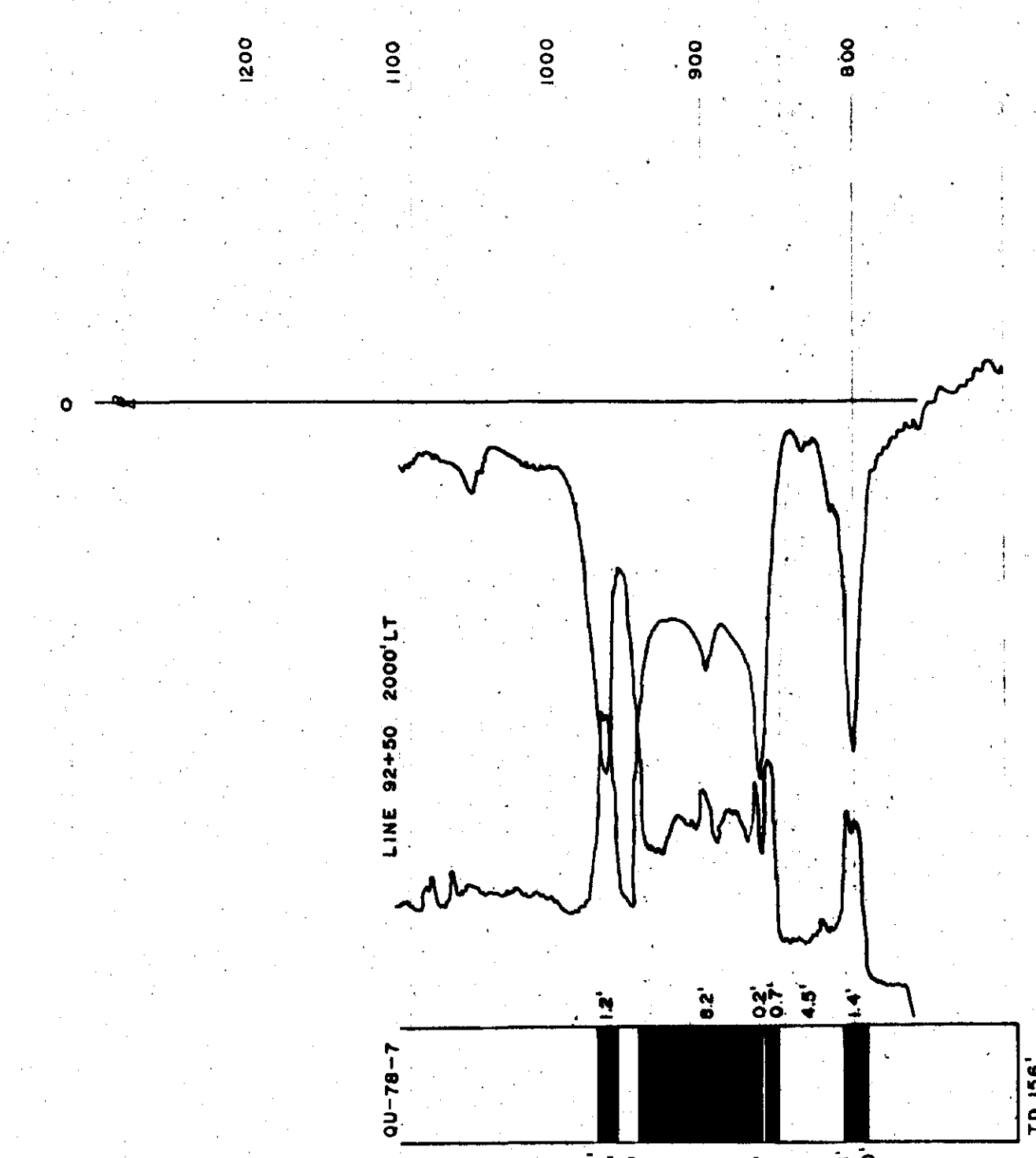
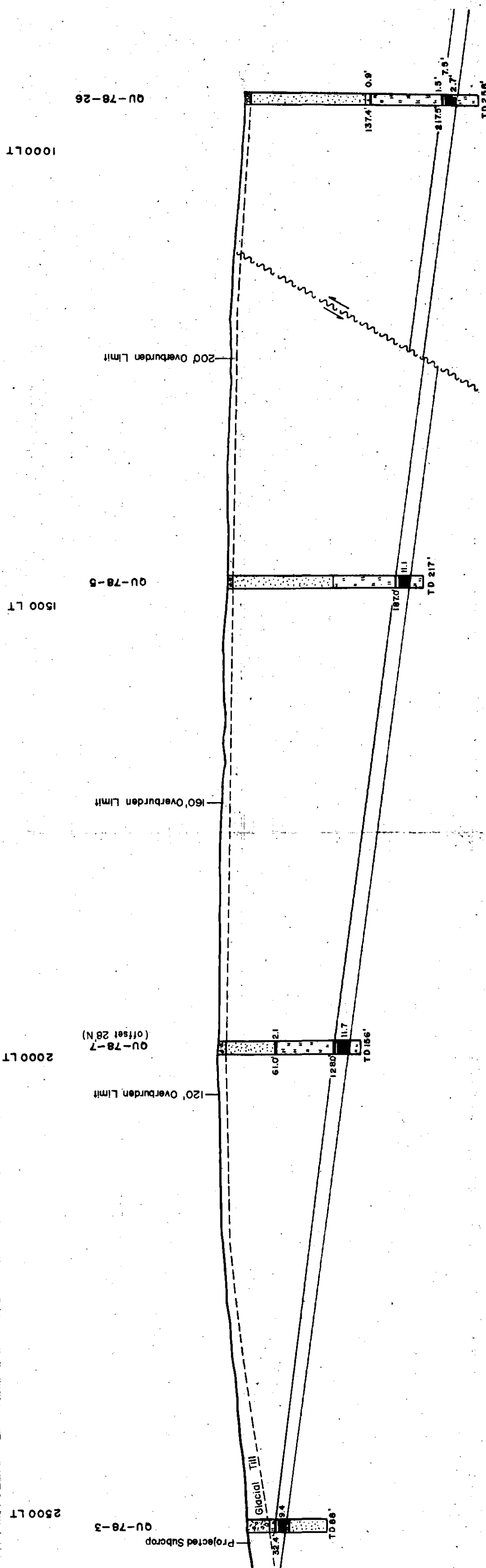

PIT 2N
 LUSCAR LTD
 QUINSAM
 LINE NO. 92+50

71
 (L7)

DATE: 25/05/78
 DRAWN BY: S.J.N.
 EX: Quinsam 78(2)A

200
 HORIZONTAL 1" = 100'
 VERTICAL 1" = 100'
 QSG 238/PH 23

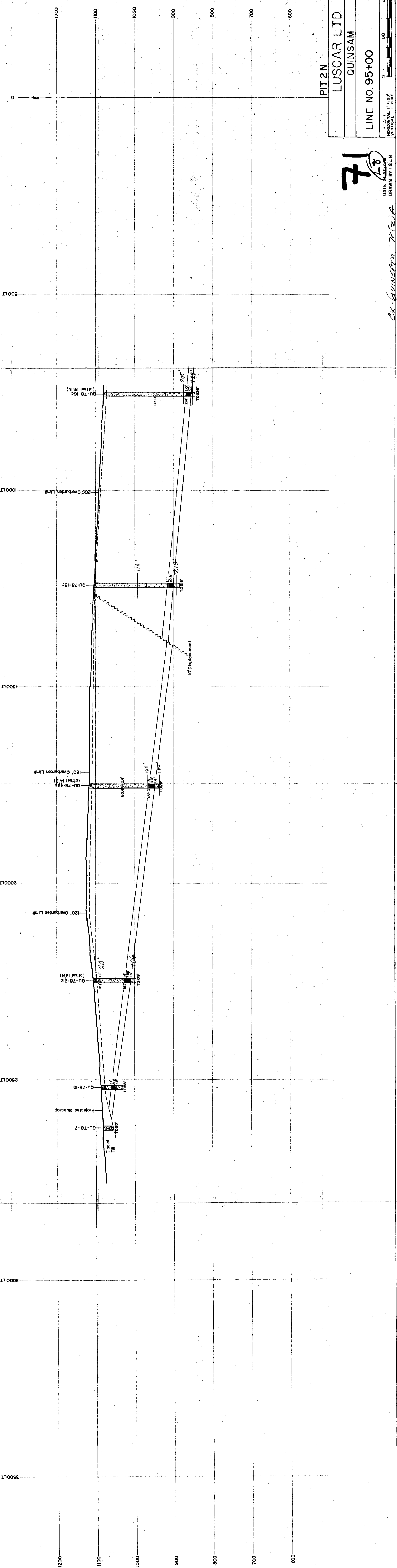

PIT 2N
 LUSCAR LTD.
 QUINSAM
 LINE NO. 95+00

71
 DATE: 5/20/88
 DRAWN BY: S.J.N.



QSG 239/PH 23

EX-QUINSAM 71(2)A

PIT 2N
 LUSCAR LTD.
 QUINSAM
 LINE NO 97+50

71
 (L9)

DATE: 25/05/78
 DRAWN BY: S.J.N.
 CX-Quinsam 7/13/78

HORIZONTAL: 1"=100'
 VERTICAL: 1"=100'
 0 100 200
 miles

QSG 240/PH23

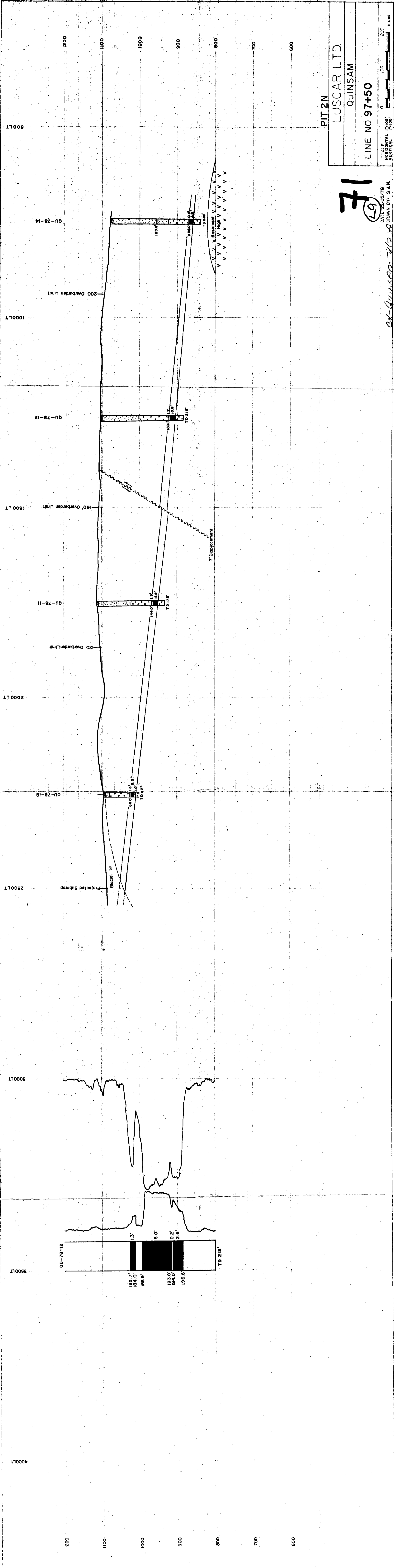

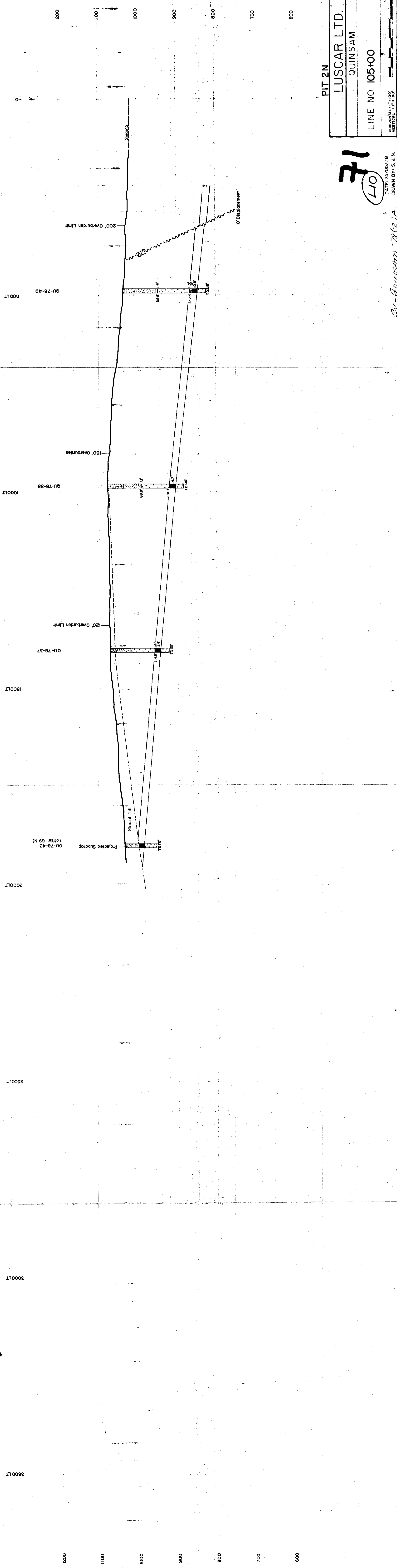

PIT 2N
 LUSCAR LTD.
 QUINSAM
 LINE NO 105+00

71
 LIO

DATE: 25/05/78
 DRAWN BY: S. J. N.

Ex-Quinsam 78(2)A

HORIZONTAL: 1" = 100'
 VERTICAL: 1" = 100'

QSG 243/PH 23

PIT 2N

LUSCAR LTD

QUINSAM

LINE NO 103+00

HORIZONTAL 1"=100'
VERTICAL 1"=100'

OSG 242/PH23

71
LII

DATE: 25/05/78
DRAWN BY: S.J.N.
ex Quinsam 242/PH23

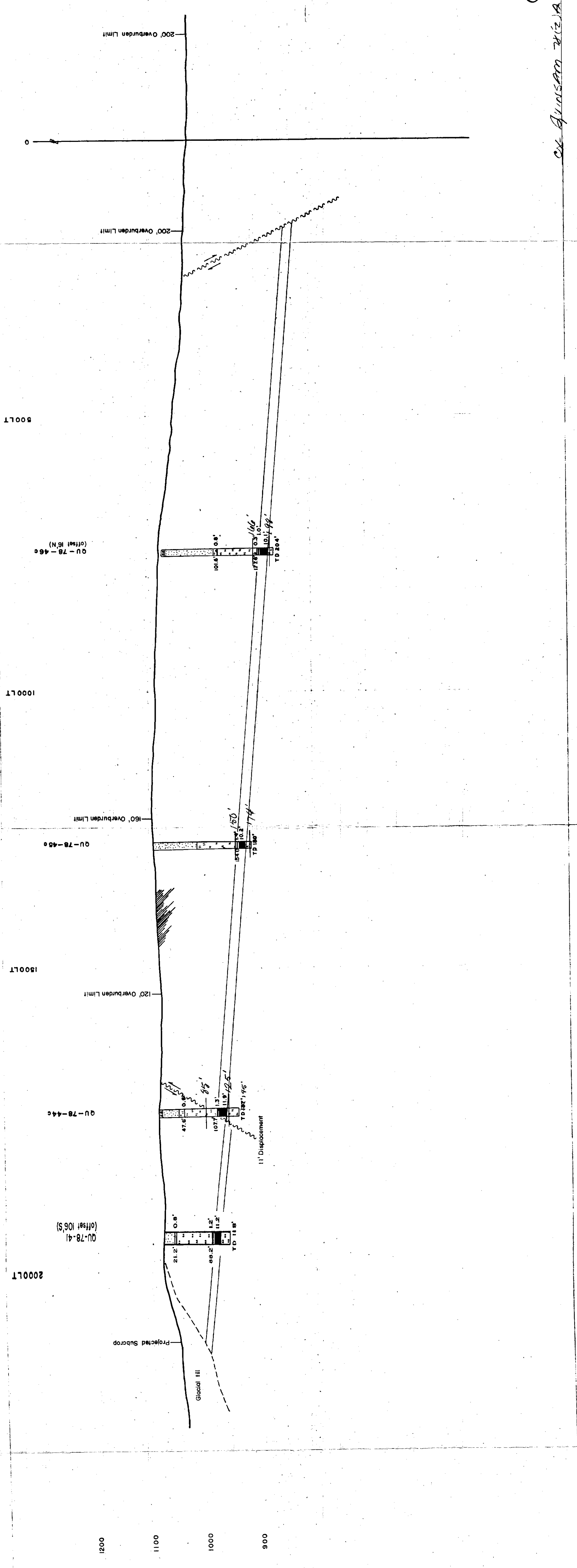

3000LT

2500LT

2000LT

1500LT

1000LT

500LT

500RT

1100

1000

900

800

700

600

500

PIT 2N

WASCAR LTD

QUINSAM

LINE NO 115+00

HORIZONTAL 1" = 100'

VERTICAL 1" = 100'

DATE 25/06/78

DRAWN BY: S.J.N.

71

EX-QUINSAM 2(2)A

500RT

500LT

1000LT

1500LT

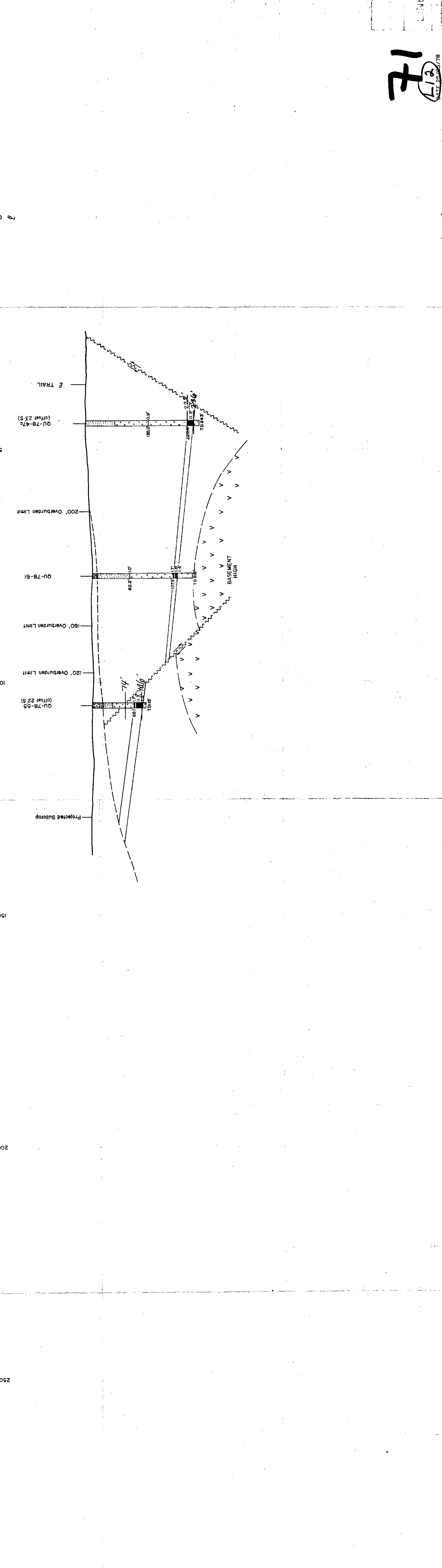

3000LT 2500LT 2000LT 1500LT 1000LT 500LT 500RT

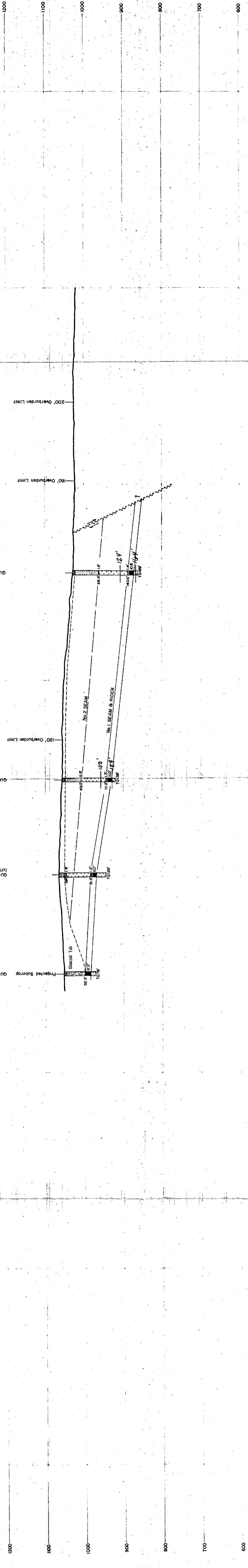

PIT 2N
 LUSCAR LTD.
 QUINSAM
 LINE NO. 107+50

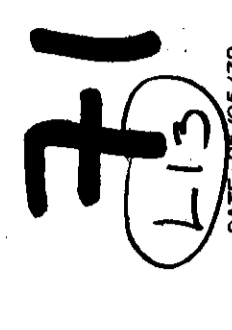

DATE: 25/05/78
 DRAWN BY: S.J.N.
 EX-ANUSON 8(3)A

HORIZONTAL: 1" = 100'
 VERTICAL: 1" = 100'
 SCALE: 1:100
 QSG 244/PH23

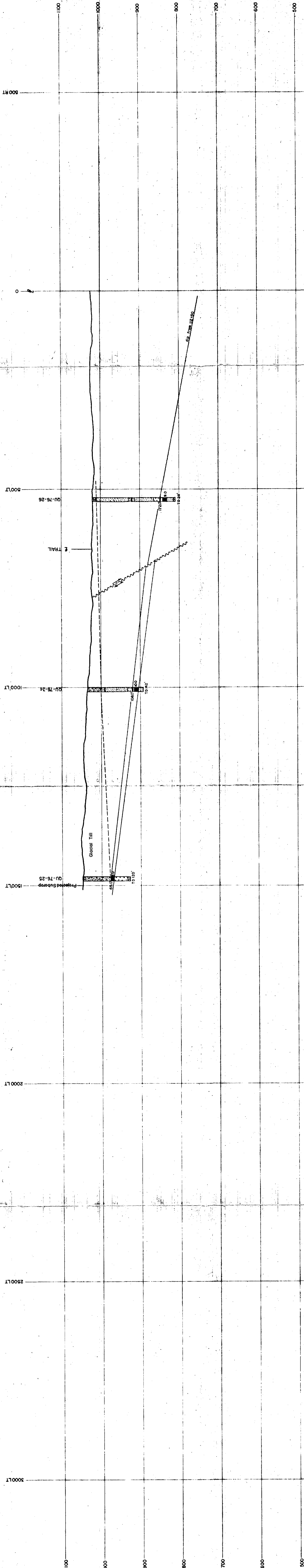

PIT 2N

LUSCAR LTD.

QUINSAM

LINE NO. 110+00



QSG 245/PH 23

71

DATE 25/05/76
DRAWN BY S.J.N.

Cx-Quinsam 78(2)A

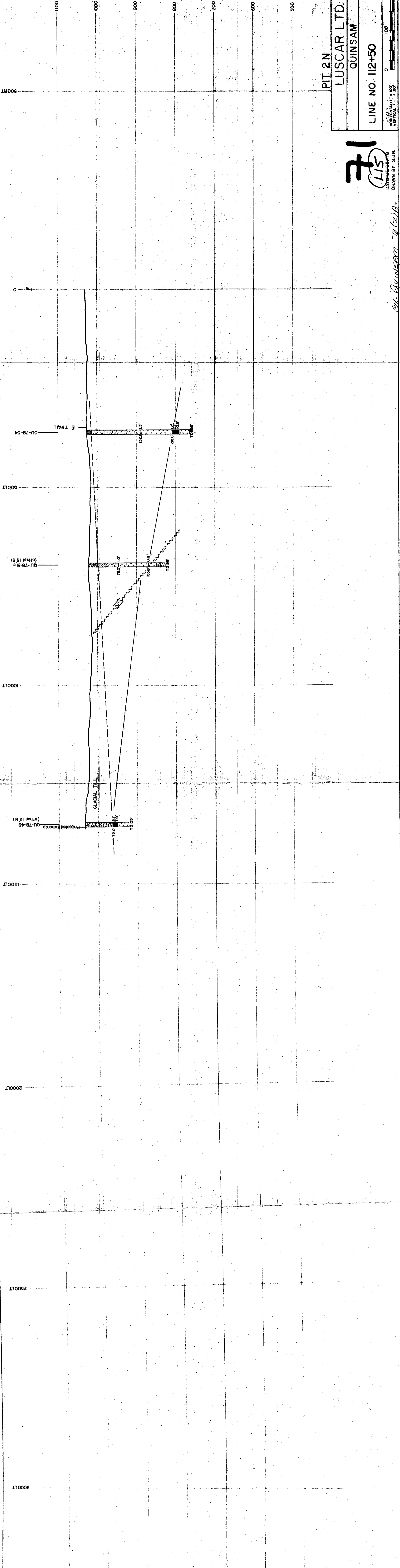

PIT 2N
 LUSCAR LTD.
 QUINSAM
 LINE NO. 112+50

71
 LIS
 DATE: 1988
 DRAWN BY: S.J.N.

ex-Quinsam 78(2)A

SCALE
 HORIZONTAL: 1" = 100'
 VERTICAL: 1" = 200'
 miles

0 100 200 miles

0 500 1000 1500 2000 2500 3000

500 600 700 800 900 1000 1100

3000LT 2500LT 2000LT 1500LT 1000LT 500LT 0

QU-78-48 (offset 12 N)

QU-78-51c (offset 16 S)

QU-78-54 (E TRAIL)

GLACIAL TILL

Projected Subcrop

72.0'

79.0'

80.6'

83.2'

83.7'

TD 100'

TD 100'

TD 100'

TD 100'

TD 100'

TD 100'

TD 100'

TD 100'

TD 100'

TD 100'

TD 100'

TD 100'

TD 100'

TD 100'

TD 100'

TD 100'

TD 100'

TD 100'

TD 100'

TD 100'

TD 100'

TD 100'

TD 100'

TD 100'

TD 100'

TD 100'

TD 100'

TD 100'

TD 100'

TD 100'

TD 100'

TD 100'

TD 100'

TD 100'

TD 100'

TD 100'

TD 100'

TD 100'

TD 100'

TD 100'

TD 100'

TD 100'

TD 100'

TD 100'

TD 100'

TD 100'

TD 100'

TD 100'

TD 100'

TD 100'

TD 100'

TD 100'

TD 100'

TD 100'

TD 100'

TD 100'

TD 100'

TD 100'

TD 100'

TD 100'

TD 100'

TD 100'

PIT 2N
 QUINSAM
 LINE NO. 117+00

71
 LIG
 DRAWN BY: S. J. N.

CGS 248/PH23

SCALE:
 HORIZONTAL: 1"=100'
 VERTICAL: 1"=500'
 0 100 200
 m. l.s.

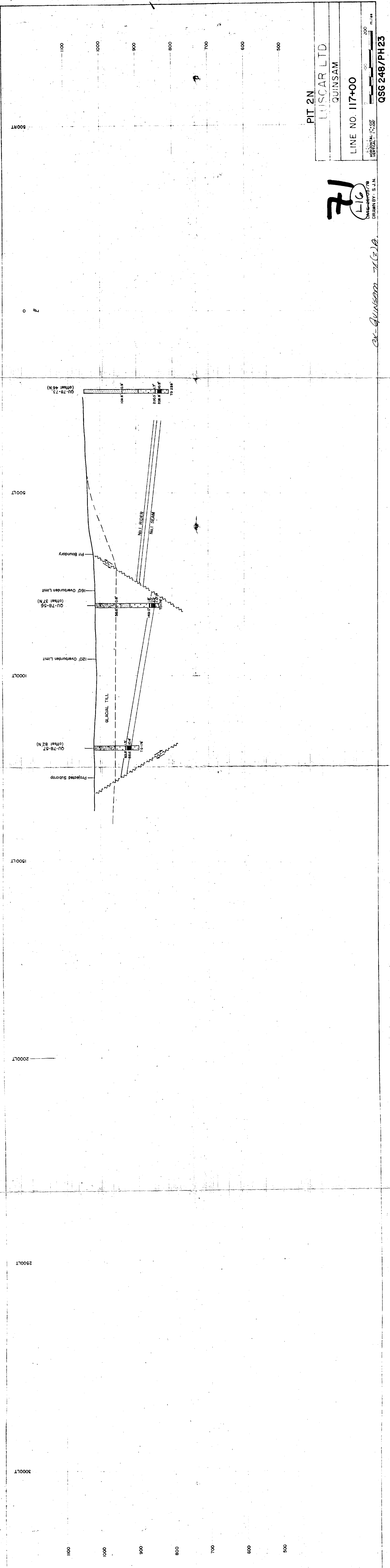

No. 2 Seam	10'
	75'
	100'
	125'
	150'
No. 1 Rider	1.3
	0.7
	47
No. 1 Seam	5.3

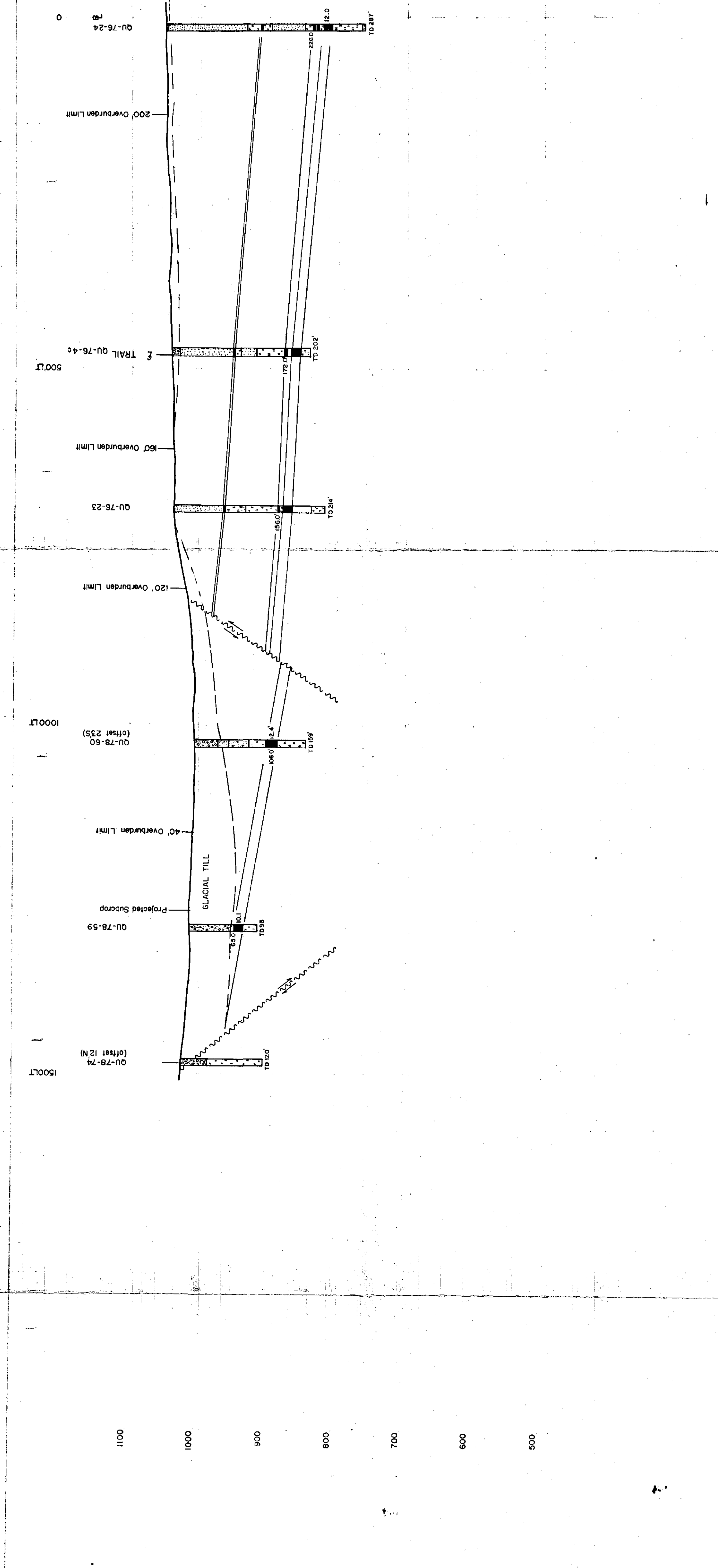

DRILL HOLE 120+00 694' LT

PIT 2N

ELLSAR LTD.

QUINSAM

LINE NO. 120+00

DATE: 05/05/78
DRAWN BY: S.J.N.

71

L17

200
HORIZONTAL 1" = 100'
VERTICAL 1" = 100'

QSG 249/PH 23

OK-AUNSAM 71 (2) A

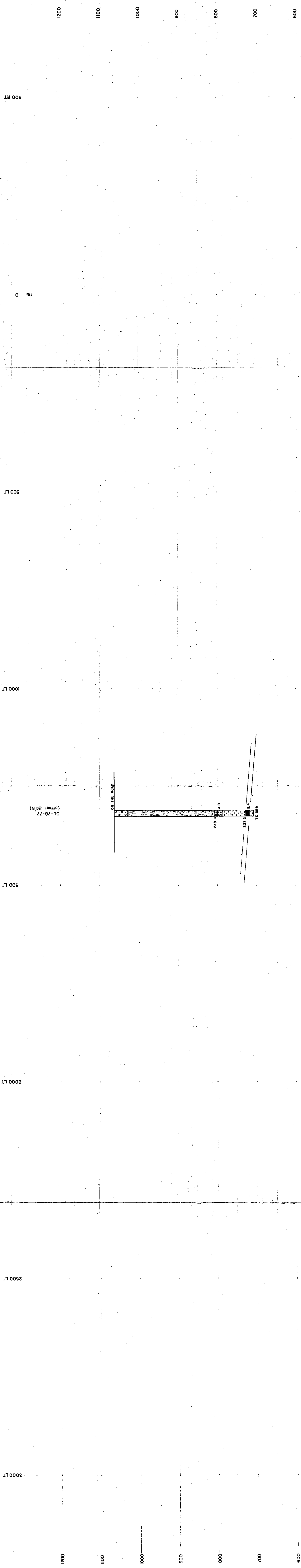

PIT 2N
 LUSCAR LTD.
 QUINSAM
 LINE NO. 122+00

71
 L18
 DATE: AUG 2, 1985
 DRAWN BY: D. PHILLIPS

ex-Quinsam 78 (2)A

HORIZONTAL: 1"=100'
 VERTICAL: 1"=100'
 30'

QSG 250/PH 23

PIT 2N
 LUSCAR LTD.
 QUINSAM
 LINE NO. 90+00

DATE 25/08/78
 DRAWN BY: S.J.N.

MOGRAPHICAL 1" = 100'
 VERTICAL 1" = 100'

71
 L19
 QX-Quinsam 78(2)A

24

0 100 200 miles

QSG 237/PH 23

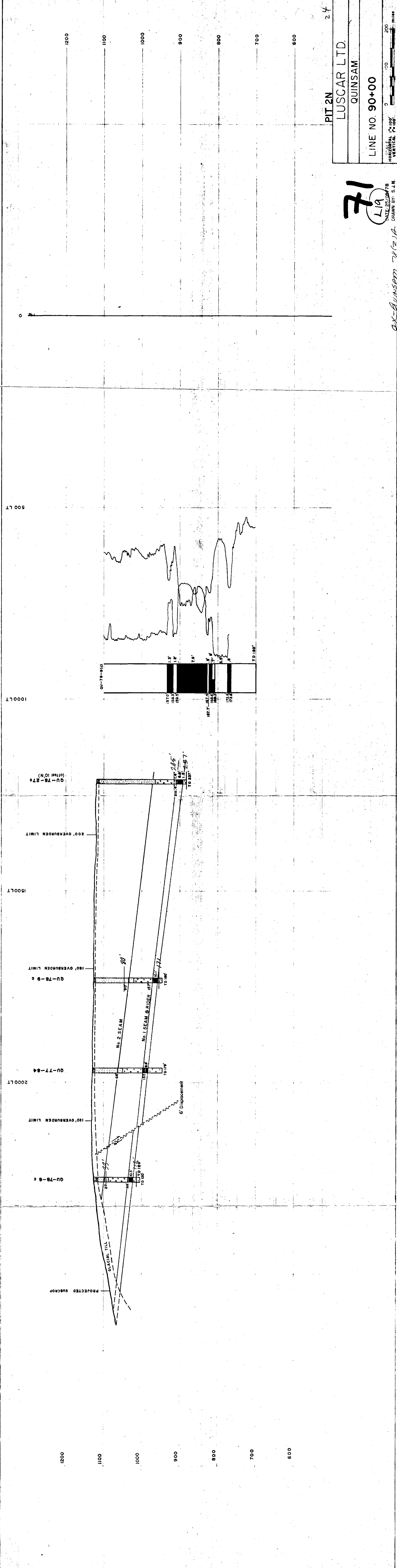

PIT 2 N
 LUSCAR LTD
 QUINSAM
 LINE NO. 85+00
 DATE: 25/05/78
 DRAWN BY: S.J.M.



DATE: 25/05/78
 DRAWN BY: S.J.M.

QSG 234/PH 25

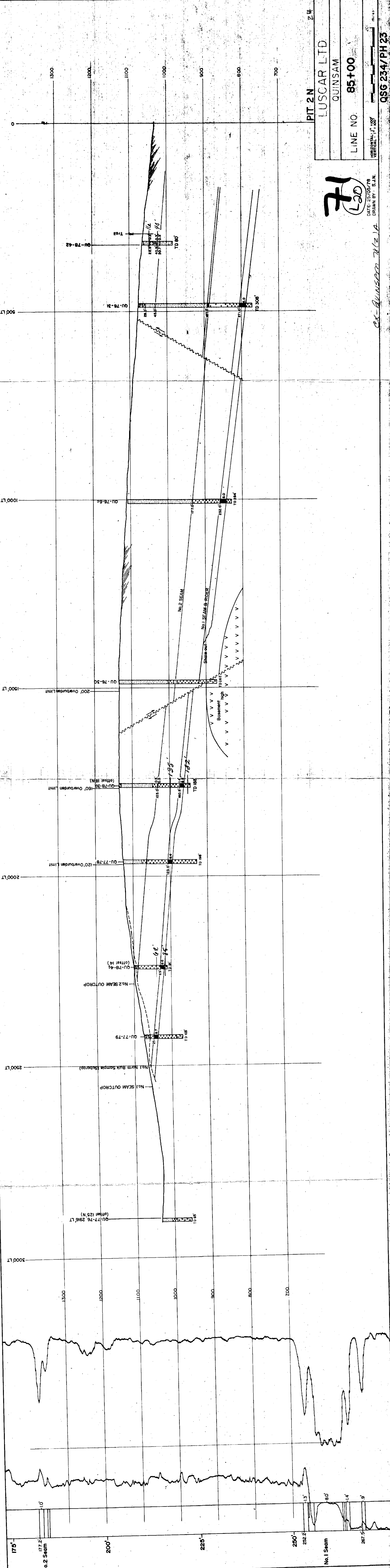

EX-QUINSAM 28(2)A

PIT 2N 2*
 LUSCAR LTD.
 QUINSAM
 LINE NO 82+50

71
 L21
 DATE: 25/05/78
 DRAWN BY S.J.N.

QSG 233/PH 23

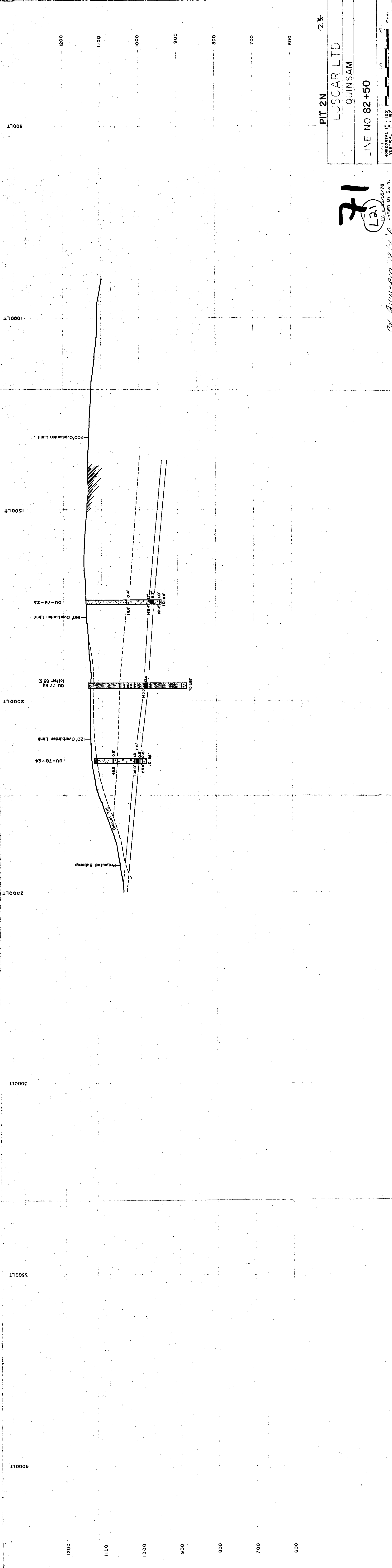

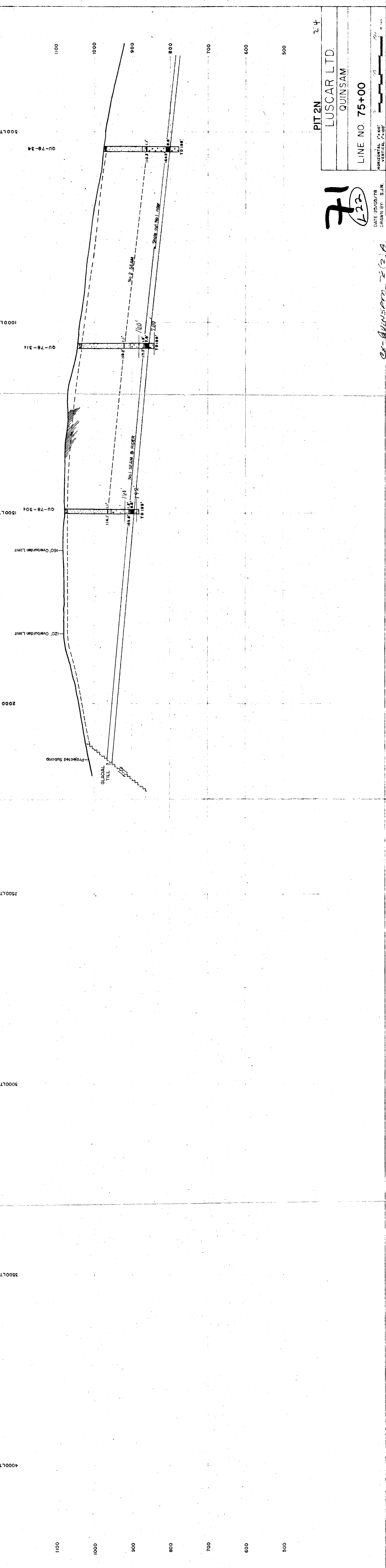

PIT 2N 24
 LUSCAR LTD.
 QUINSAM
 LINE NO. 75+00

71
 (722)

DATE 25/05/78
 DRAWN BY S.J.N.

ex-Quinsam 2(2)A

HORIZONTAL 1" = 100'
 VERTICAL 1" = 100'

QSG 230/PH 23

71
 (23)
 DANIELS/DJ/B
 DRAWN BY S.J.N.
 EX-AMUNSON 78 1/2 A

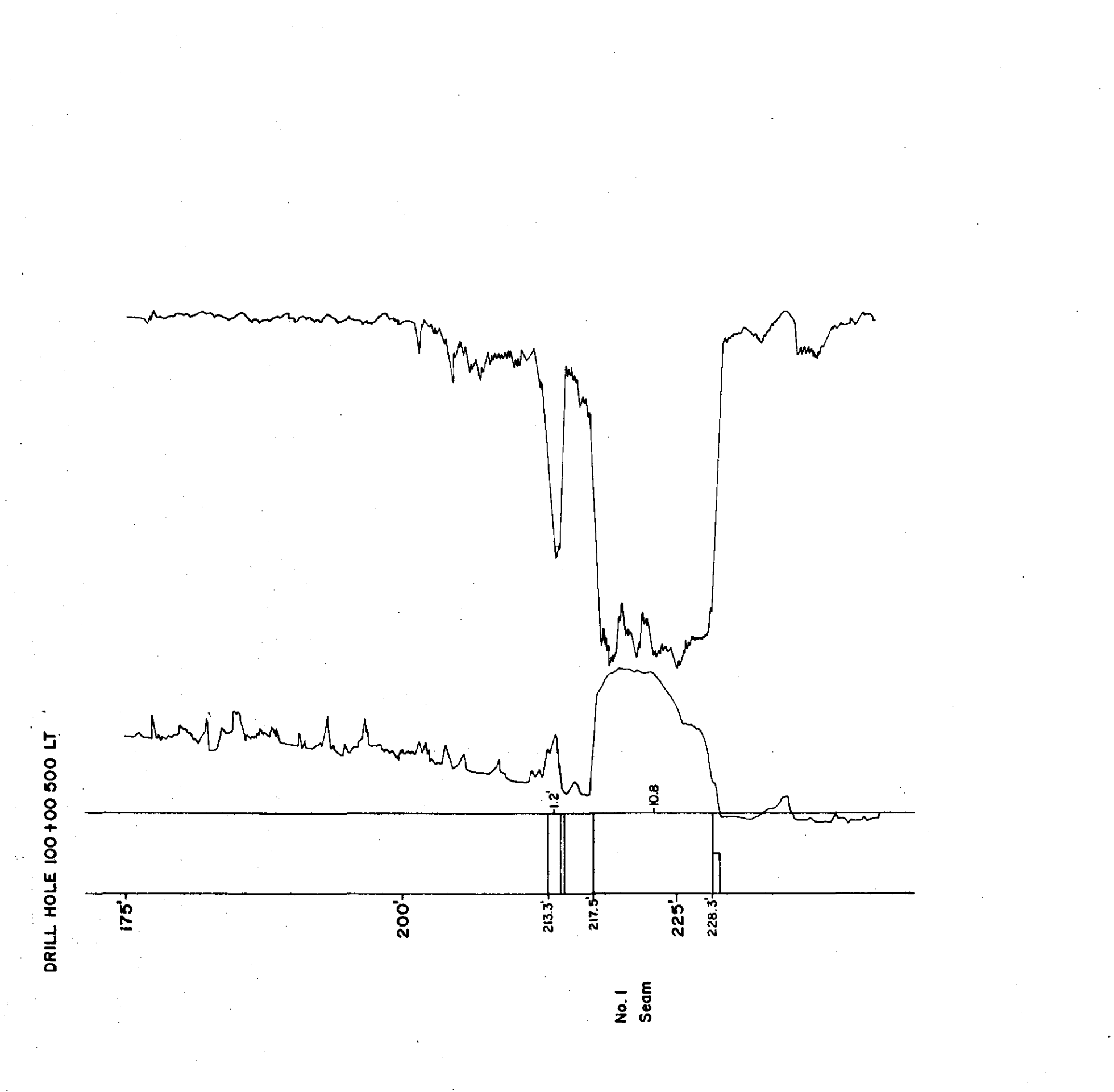
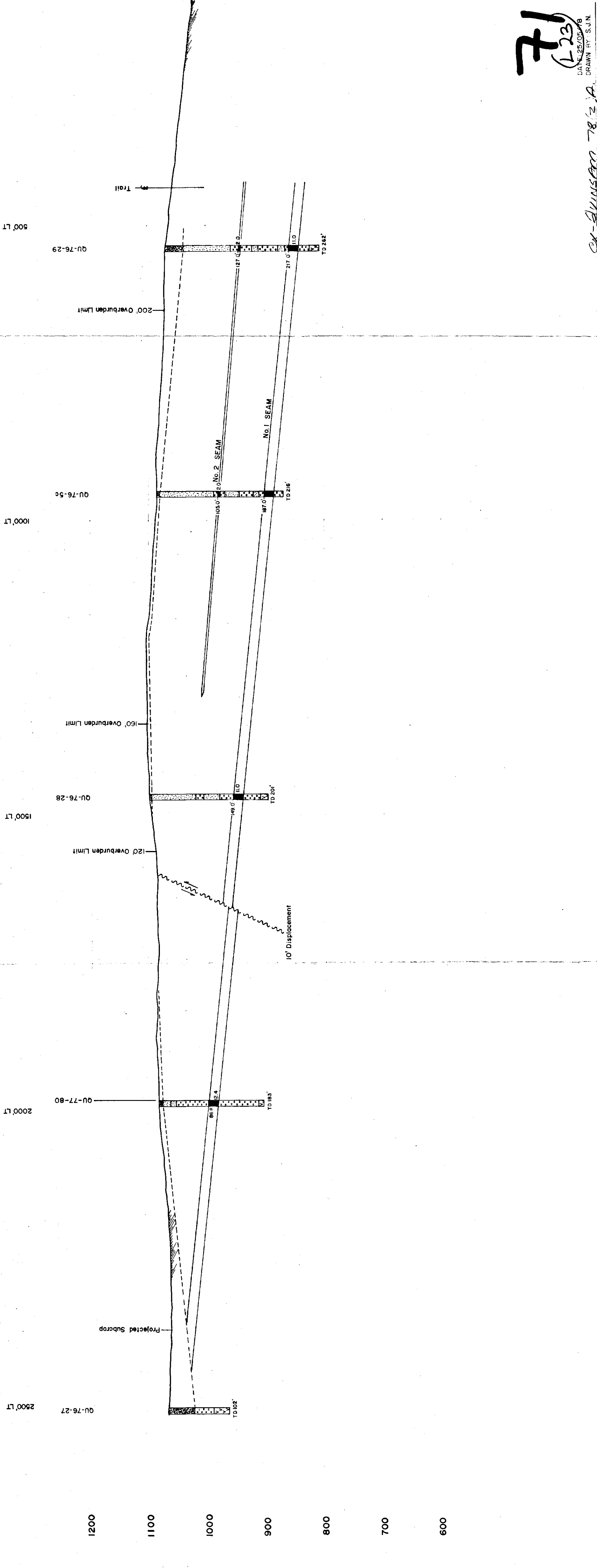

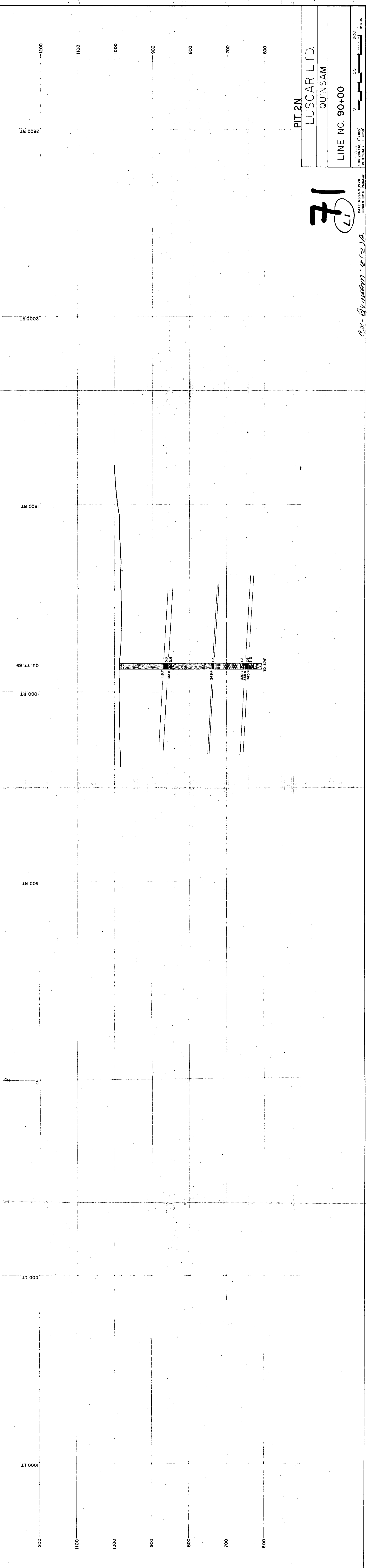

PIT 2N
 LUSCAR LTD.
 QUINSAM
 LINE NO. 90+00

71
 LI

HORIZONTAL: 1" = 100'
 VERTICAL: 1" = 100'

DATE: March 5, 1979
 DRAWN BY: D. Palmer

EX-Quinsam 78 (2) A

200 100 0 100 200
 Miles

QSG 236/PH23

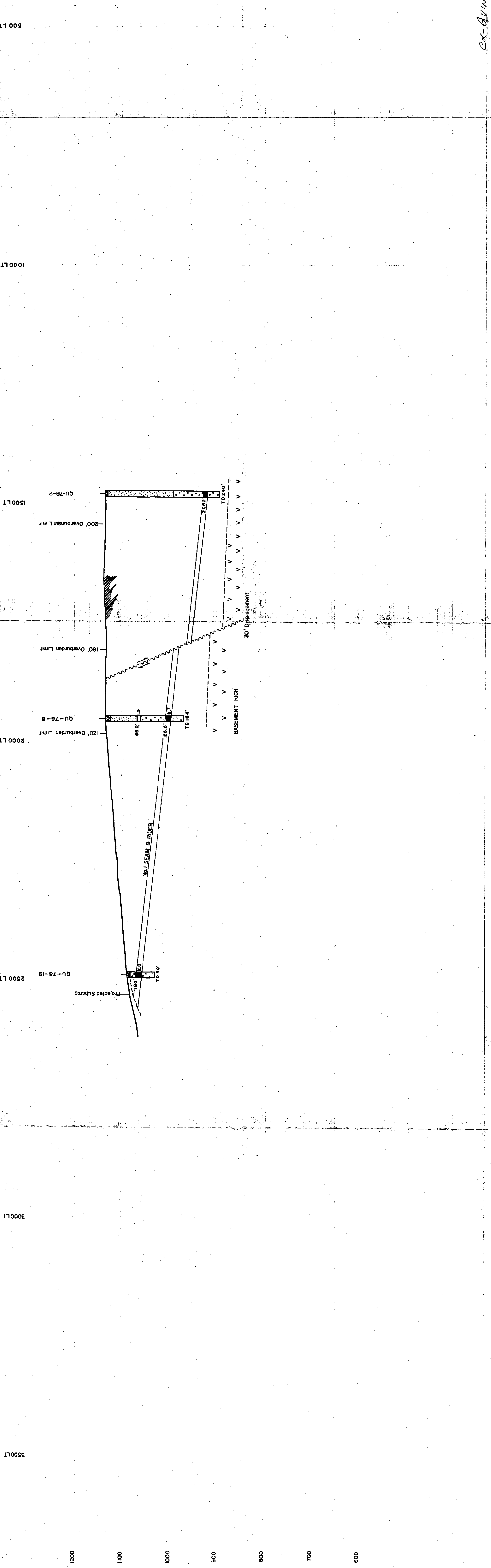
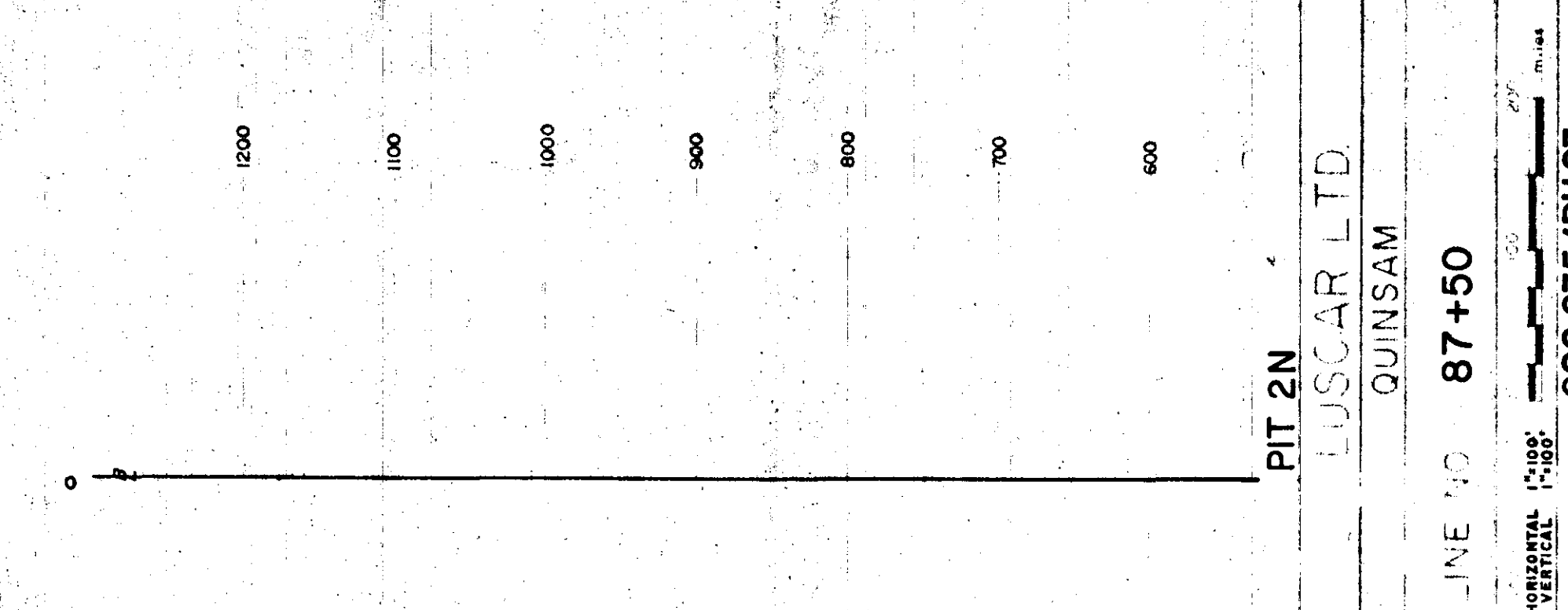

PIT 2N
 LUSCAR LTD.
 QUINSAM
 LINE NO 87+50
 HORIZONTAL 1"=100'
 VERTICAL 1"=100'

71
 (2)
 DATE: 25/03/78
 DRAWN BY: S.J.N.
 EX-Quinsam - RZA

QSG 235/PH 23

PIT 2N
 LUSCAR LTD
 QUINSAM
 LINE NO 80+00

71
 (L3)

DATE: 25/05/78
 DRAWN BY: J. N.
 EX: AUNSON

HORIZONTAL 1"=100'
 VERTICAL 1"=100'

QSG 232/PH 23

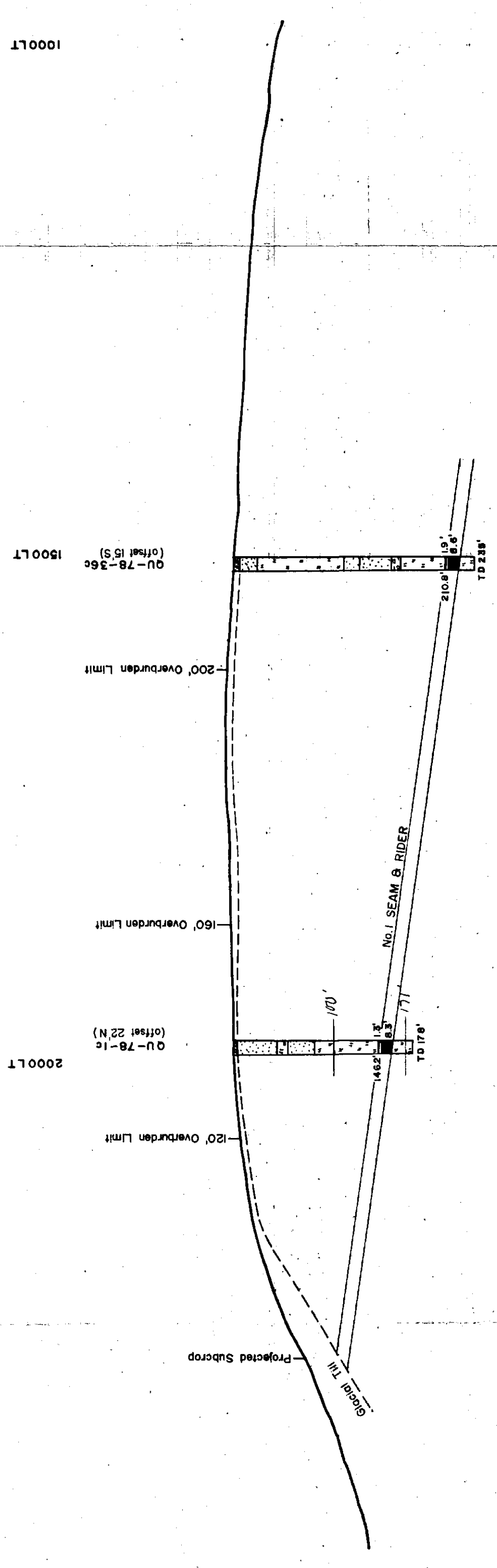

0 200 400
HORIZONTAL 1" = 100'
VERTICAL 1" = 100'

DATE: 25/05/78
DRAWN BY: S.J.N.

EX-QUINSAM 78 (2) A

71

(L4)

PIT 2N
LUSCAR LTD.
QUINSAM

LINE NO. 77+50

QSG 231/PH23

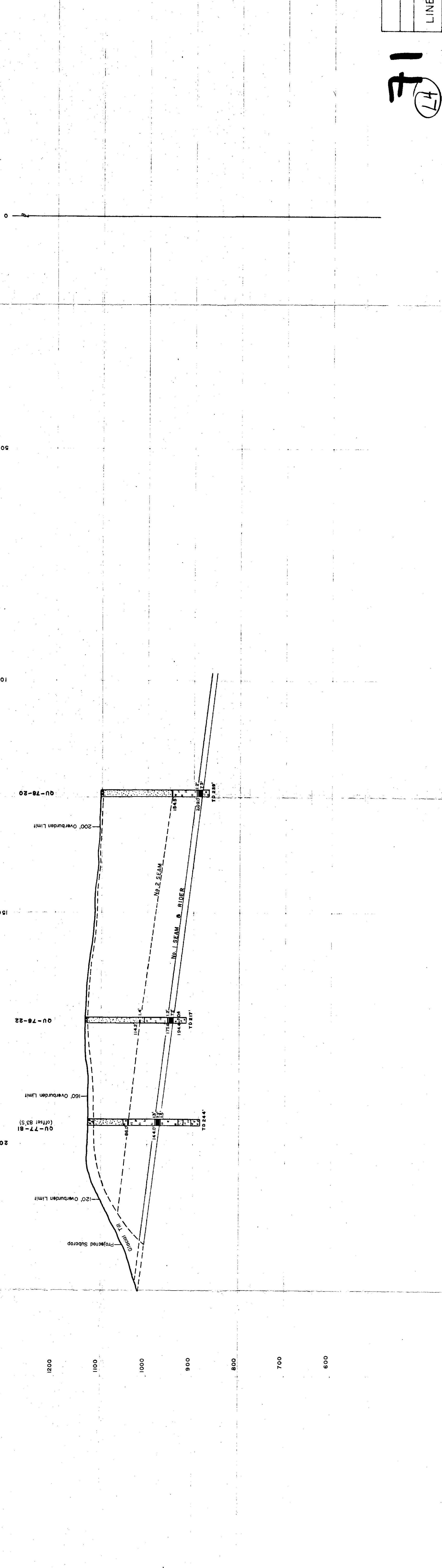

0

500LT

1000LT

1500LT

2000LT

1200

1100

1000

900

800

700

600

PIT 2N
 LUSCAR LTD.
 QUINSAM
 LINE NO. 72+50

71
 (LS)

DATE: 25/05/78
 DRAWN BY: S.J.N.

EX-QUINSAM 78(2)A

HORIZONTAL SCALE: 1" = 100'
 VERTICAL SCALE: 1" = 20'
 QSG 229/PH 23

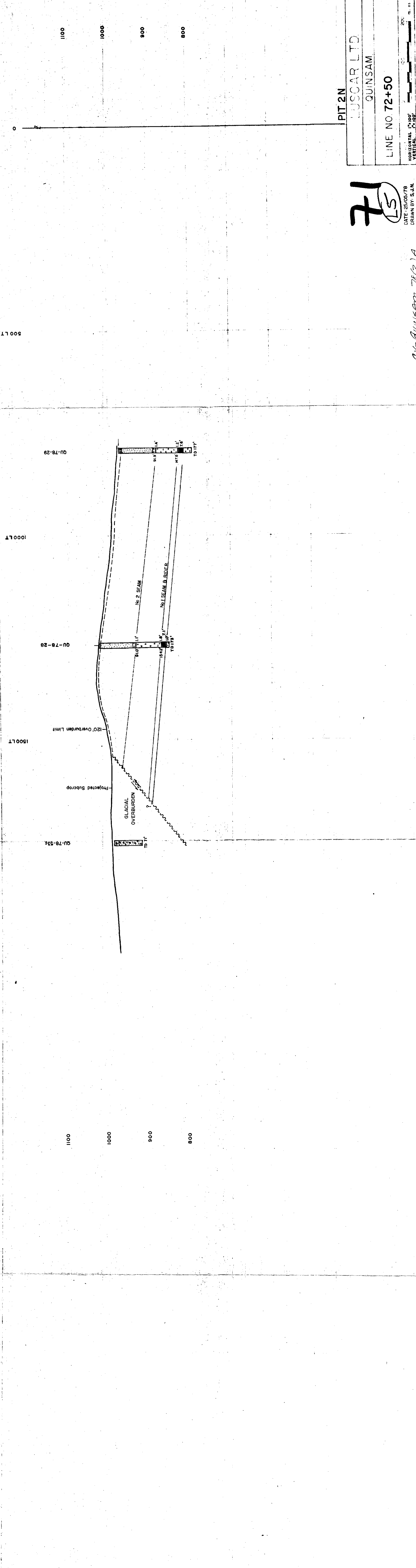

3500 LT
3000 LT
2500 LT
2000 LT
1500 LT
1000 LT
500 LT

500 LT
1000 LT
1500 LT
2000 LT
2500 LT
3000 LT
3500 LT

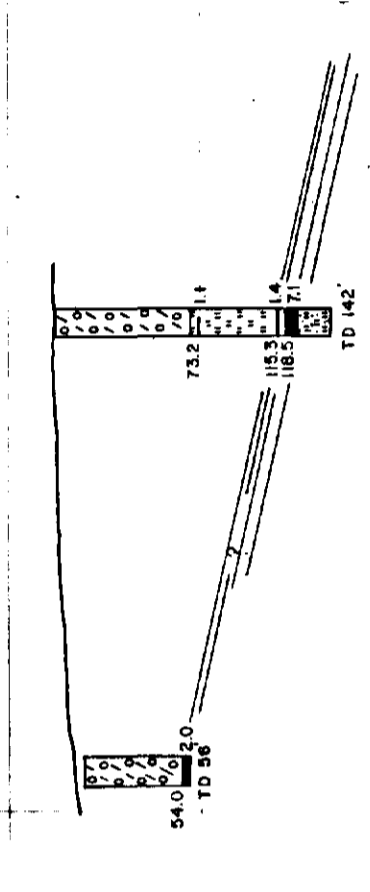

PIT 2 N
 LUSCAR LTD.
 QUINSAM
 LINE NO. 70+00

71
 (76)

DATE: March 2, 1979
 DRAWN BY: S. Palmer
 SCALE:
 HORIZONTAL: 1" = 100'
 VERTICAL: 1" = 100'
 200' 0' 200' 0' 200'
 MILES

EX-QUINSAM 70 (2) A

QSG 228/PH 23

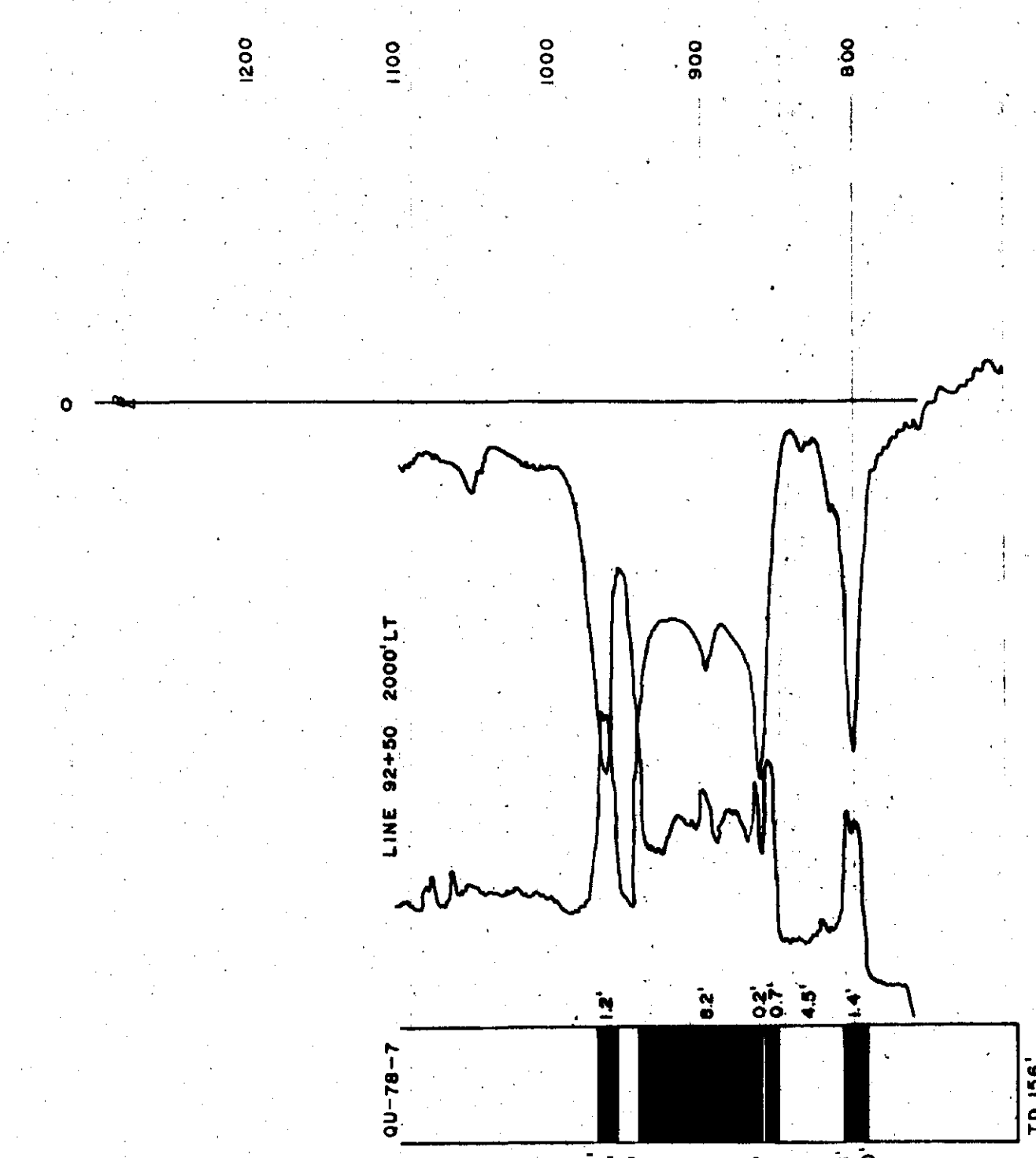
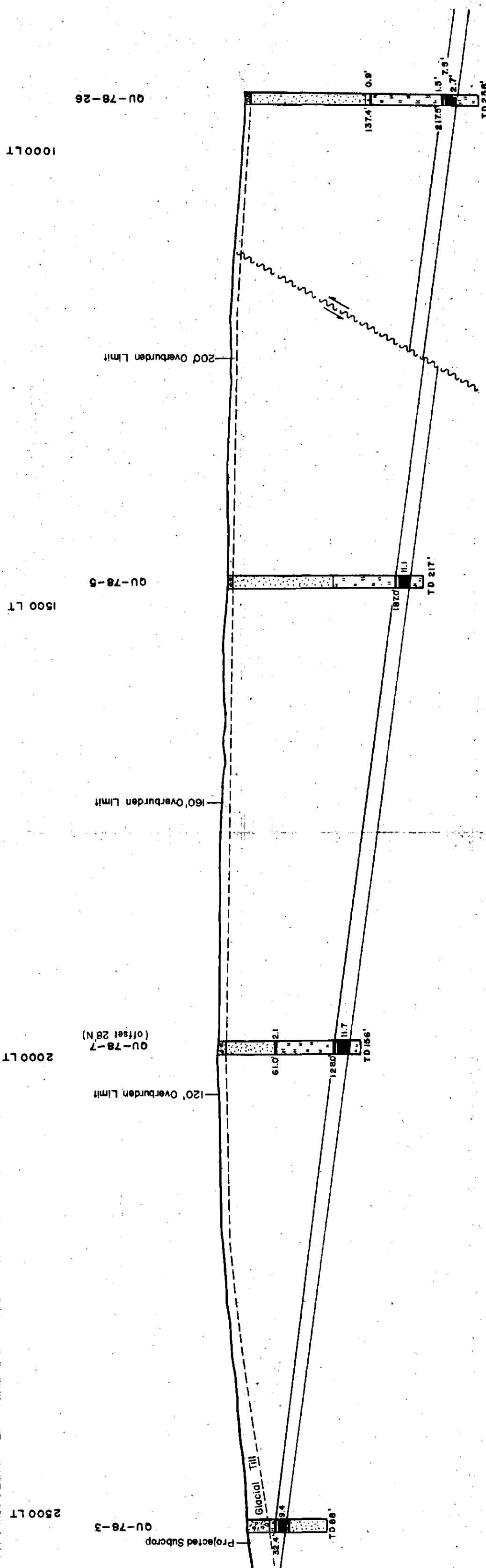

PIT 2N
 LUSCAR LTD
 QUINSAM
 LINE NO. 92+50

71
 (L7)

DATE: 25/05/78
 DRAWN BY: S.J.N.
 QUINSAM 78(2)A

VERTICAL SCALE: 1" = 100'
 HORIZONTAL SCALE: 1" = 100'

QSG 238/PH 23

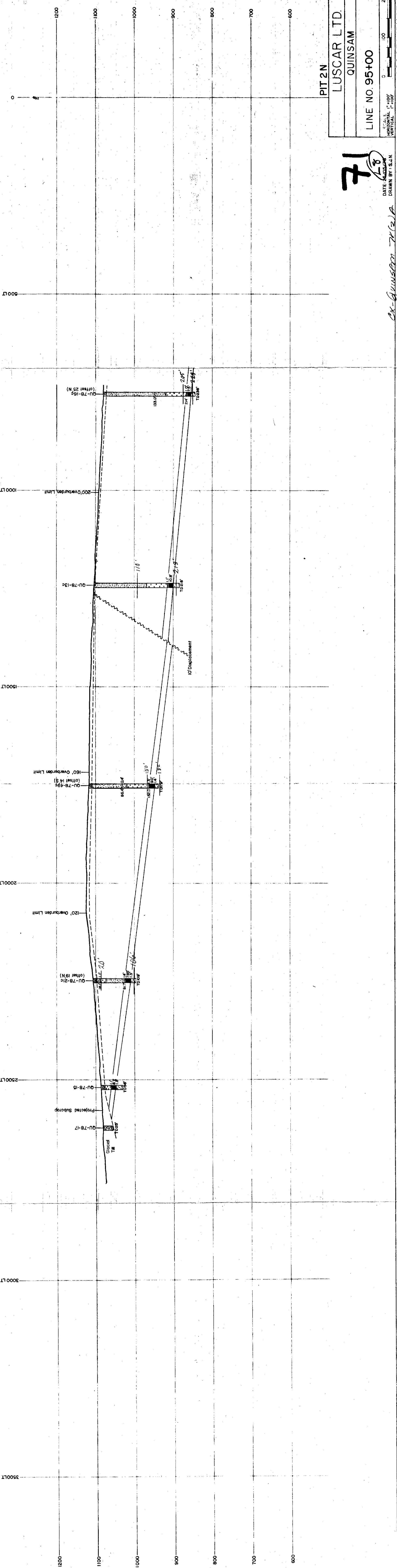

PIT 2N
 LUSCAR LTD.
 QUINSAM
 LINE NO. 95+00

DATE: 5/20/88
 DRAWN BY: S.J.N.
 SCALE: HORIZONTAL 1" = 100'
 VERTICAL 1" = 10'



71
 EX-QUINSAM 71(2)A
 QSG 239/PH 23

PIT 2N
 LUSCAR LTD.
 QUINSAM
 LINE NO 97+50

71
 (L9)

DATE: 25/05/78
 DRAWN BY: S.J.N.
 CX-Quinsam 7/13/78

HORIZONTAL: 1"=100'
 VERTICAL: 1"=100'
 0 100 200
 miles

QSG 240/PH23

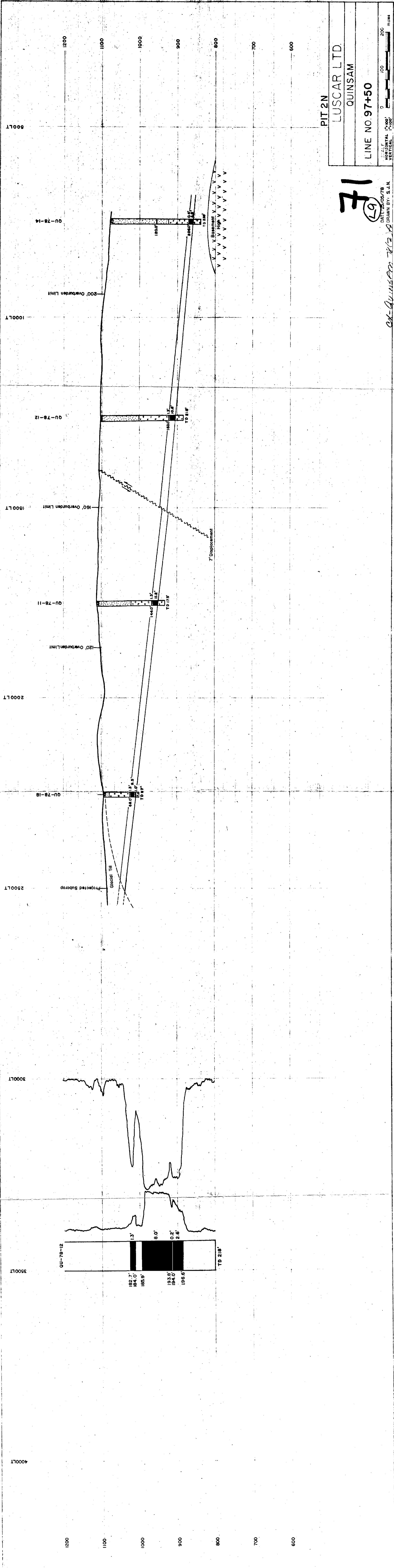

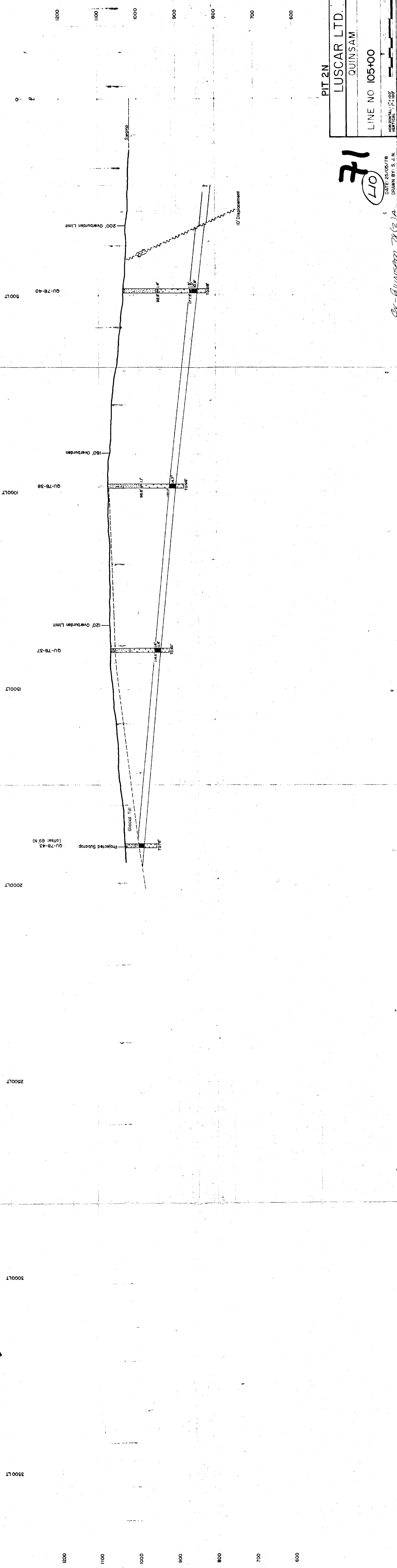

PIT 2N
 LUSCAR LTD.
 QUINSAM
 LINE NO 105+00

71
 LIO

DATE: 25/05/78
 DRAWN BY: S. J. N.

Ex-Quinsam 78(2)A

HORIZONTAL: 1" = 100'
 VERTICAL: 1" = 100'

QSG 243/PH 23

PIT 2N

LUSCAR LTD

QUINSAM

LINE NO 103+00

HORIZONTAL 1"=100'
VERTICAL 1"=100'

OSG 242/PH23

71
LI

DATE: 25/05/78
DRAWN BY: S.J.N.

ex Quinsam 242/A

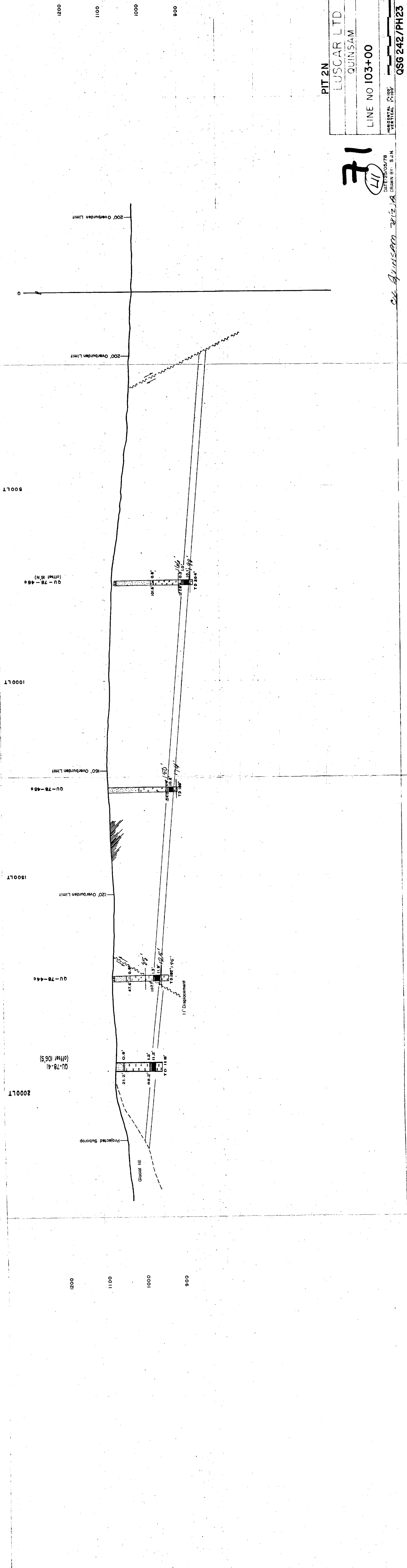

3000LT

2500LT

2000LT

1500LT

1000LT

500LT

500RT

1100

1000

900

800

700

600

500

PIT 2N

WASCAR LTD

QUINSAM

LINE NO 115+00

HORIZONTAL 1" = 100'

VERTICAL 1" = 100'

DATE 25/06/78

DRAWN BY S.J.N.

71

EX-QUINSAM 2(2)A

500RT

500LT

1000LT

1500LT

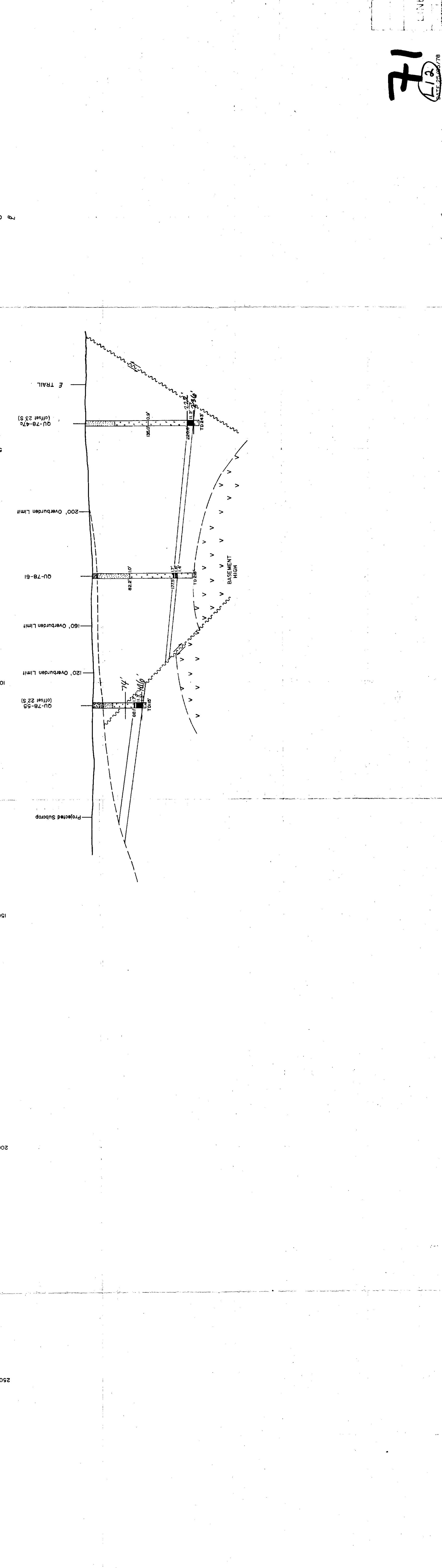

3000LT 2500LT 2000LT 1500LT 1000LT 500LT 500RT

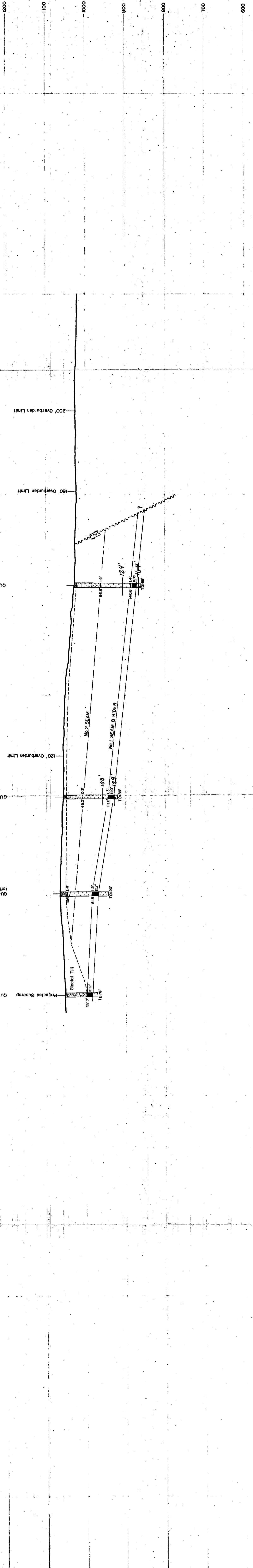

PIT 2N
 LUSCAR LTD.
 QUINSAM
 LINE NO. 107+50

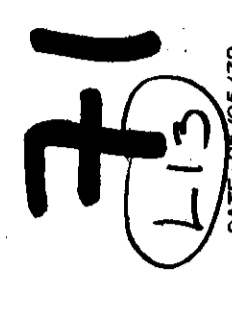

DATE: 25/05/78
 DRAWN BY: S.J.N.
 ex-AUNSON 8(3)A

HORIZONTAL: 1" = 100'
 VERTICAL: 1" = 100'
 0 100 200
 miles
 QSG 244/PH23

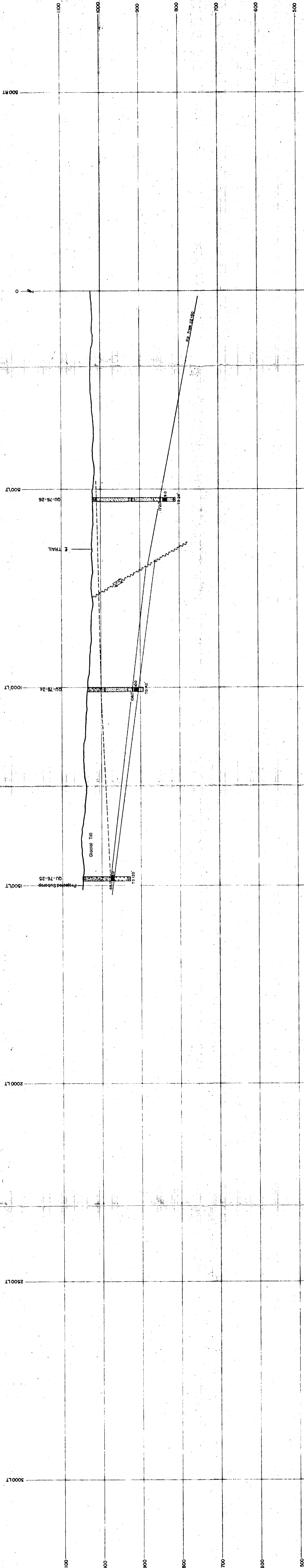

PIT 2N
 LUSCAR LTD.
 QUINSAM
 LINE NO. 110+00

71

DATE 25/05/76
 DRAWN BY S.J.N.

Scale:
 HORIZONTAL: 1" = 100'
 VERTICAL: 1" = 100'

0 100 200
 MILES

CS-Quinson 78(2)A

QSG 245/PH 23

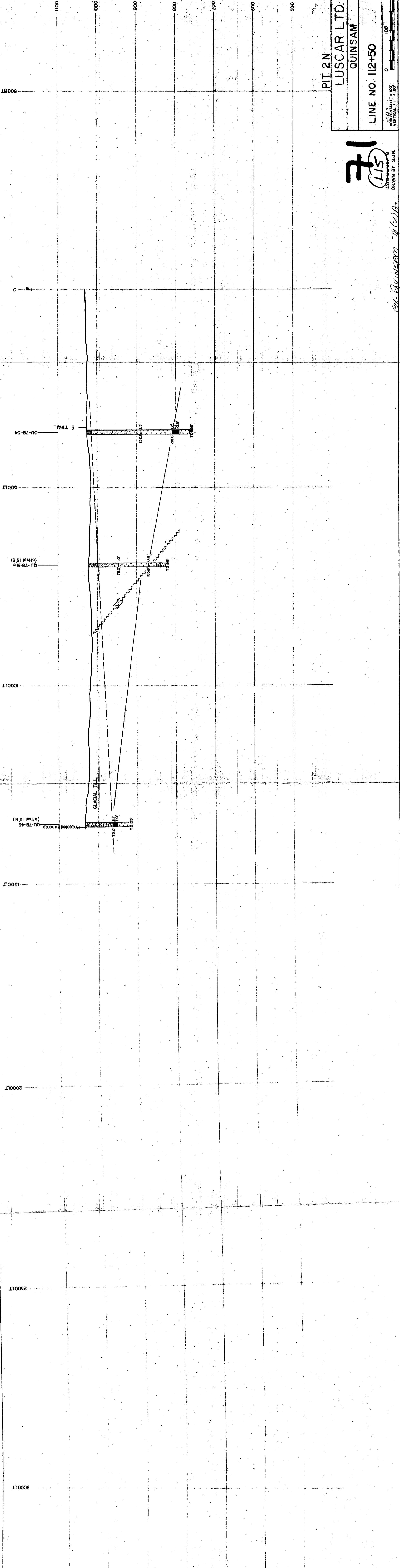

PIT 2N
 LUSCAR LTD.
 QUINSAM
 LINE NO. 112+50

71
 LIS
 DATE: 1988
 DRAWN BY: S.J.N.

ex-Quinsam 78(2)A

SCALE
 HORIZONTAL: 1" = 100'
 VERTICAL: 1" = 20'
 0 100 200
 feet

QSG246/PH23

PIT 2N
 QUINSAM LTD
 QUINSAM
 LINE NO. 117+00

71
 LIG
 QUINSAM/78
 DRAWN BY: S. J. N.

SCALE:
 HORIZONTAL: 1"=100'
 VERTICAL: 1"=500'
 0 100 200
 m. l.s.

QSG 248/PH23

ex-Quinsam - 11(2)A

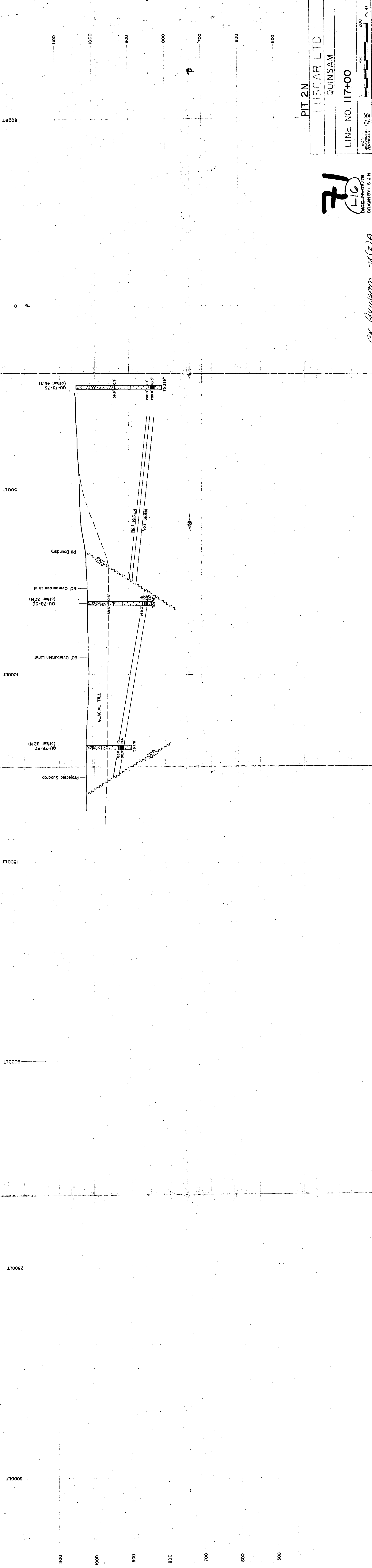

DRILL HOLE 120+00 694' LT

No. 2 Seam	75'	100'	125'	150'	No. 1 Rider	47'	No. 1 Seam	5.3'

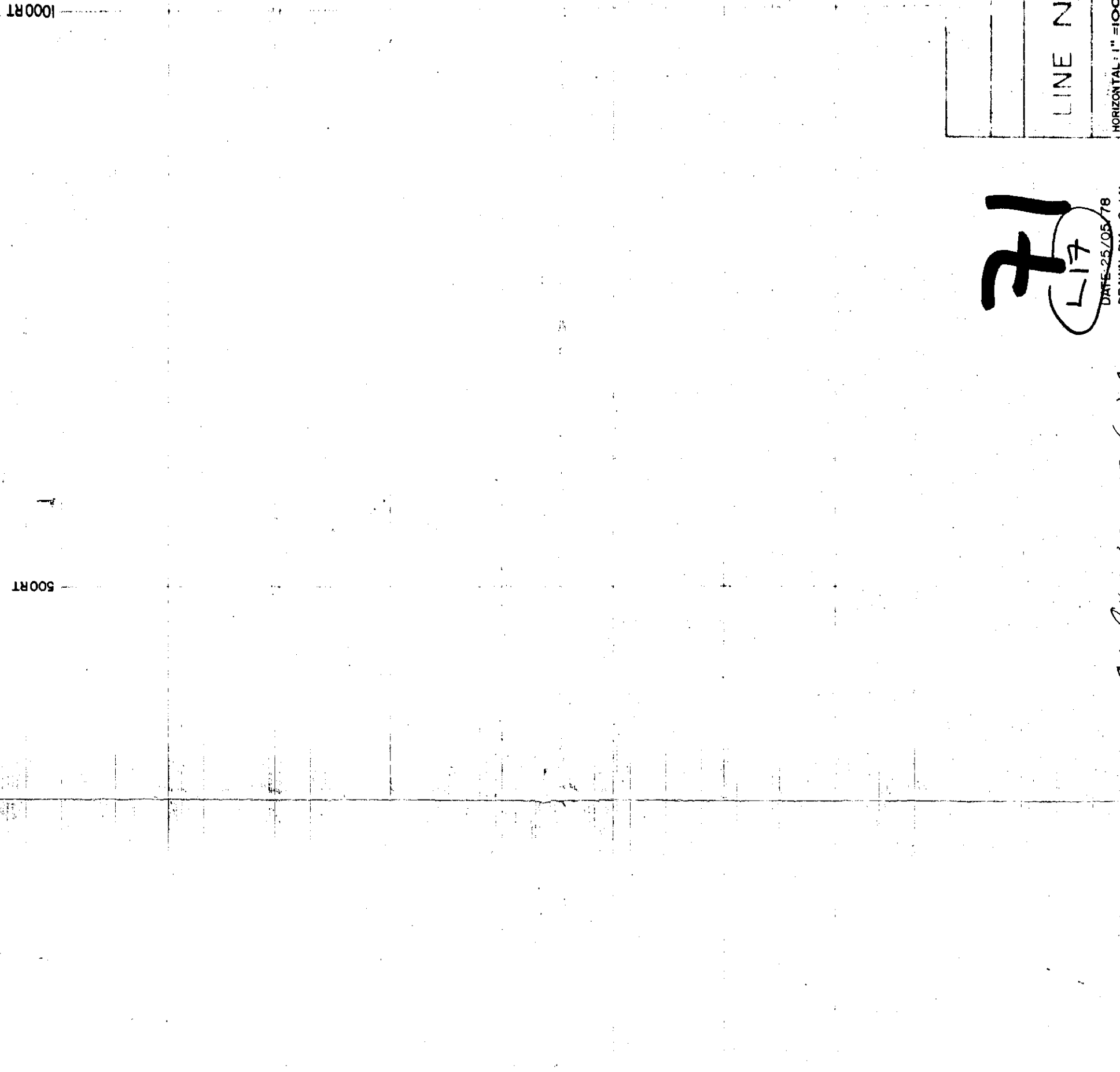
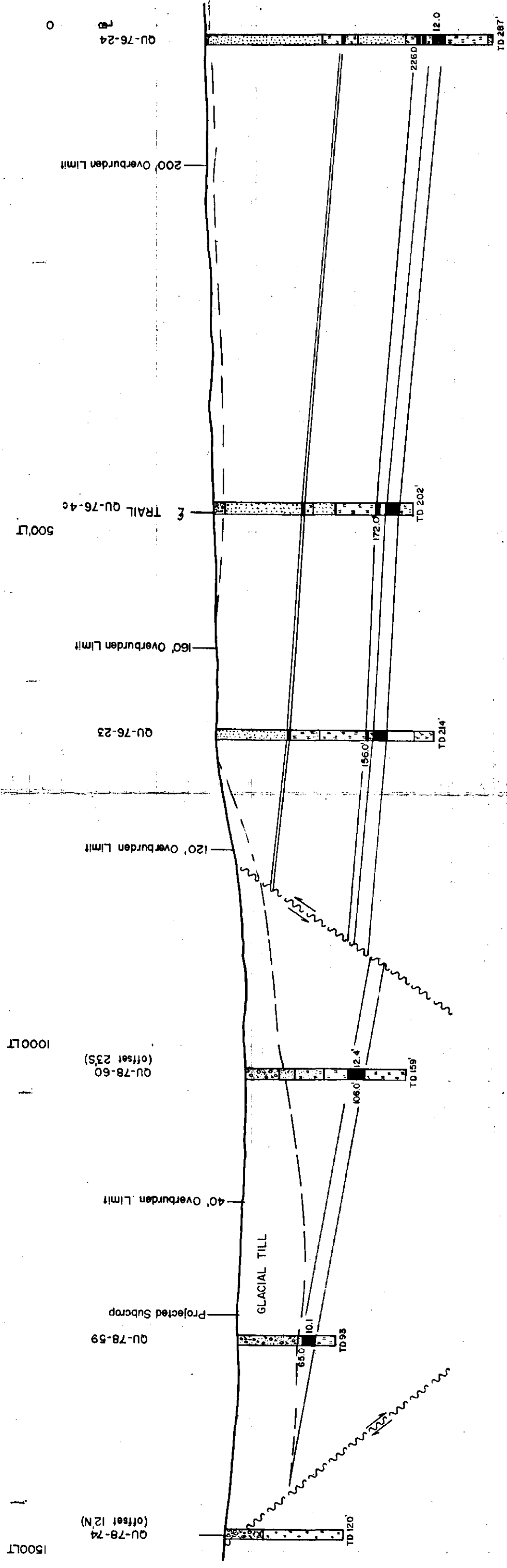
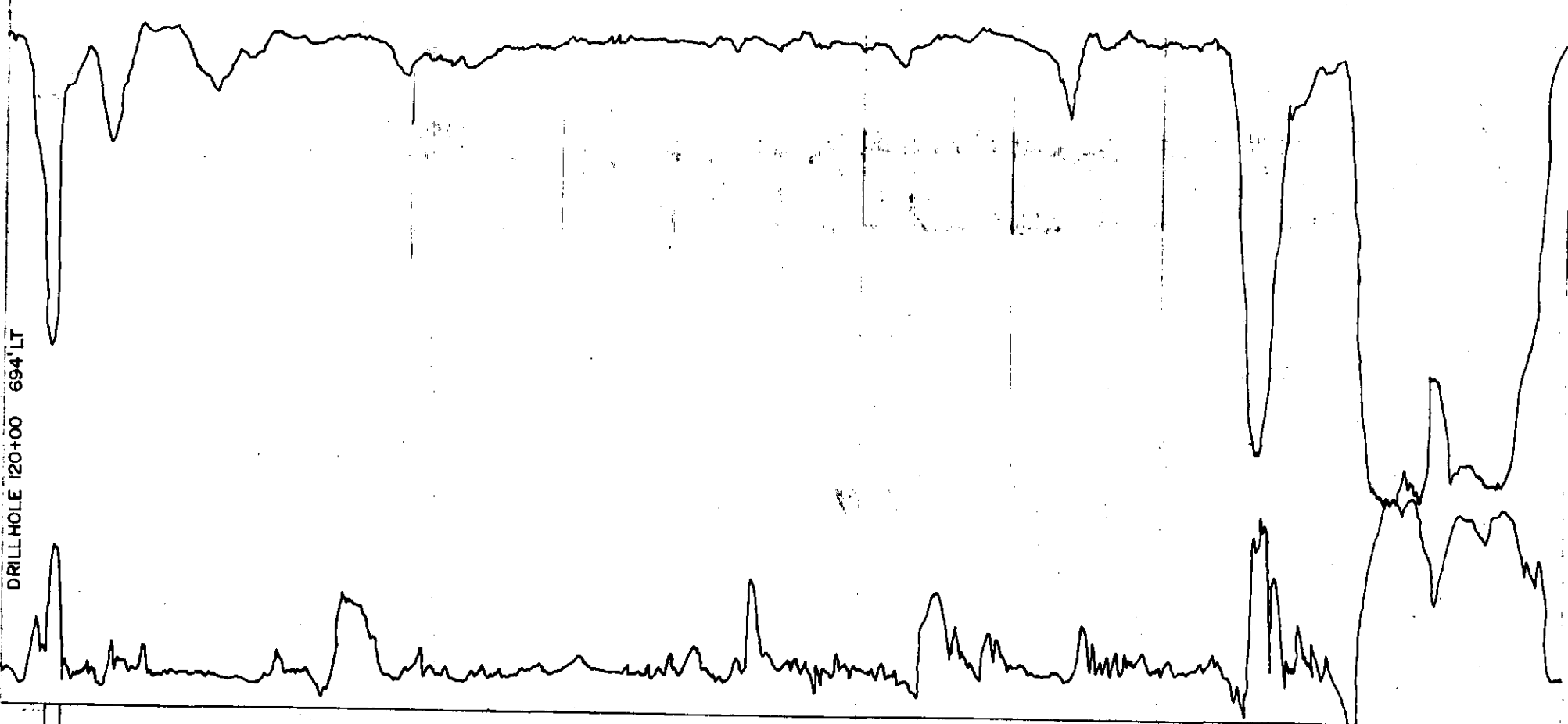

PIT 2N
 LUSCAR LTD.
 QUINSAM
 LINE NO. 120+00
 HORIZONTAL 1" = 100'
 VERTICAL 1" = 100'

71
 L17
 DATE: 05/05/78
 DRAWN BY: S.J.N.

OS-QUINSAM-71(2)A

QS6249/PH23

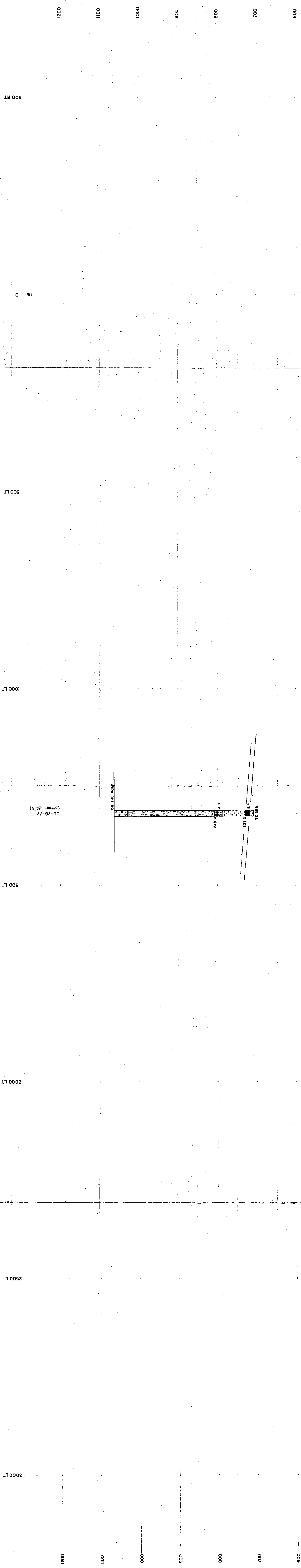

PIT 2N
 LUSCAR LTD.
 QUINSAM
 LINE NO. 122+00

71
 L18
 DATE: AUG 2, 1985
 DRAWN BY: D. PHILLIPS

ex-Quinsam 78 (2)A

HORIZONTAL: 1"=100'
 VERTICAL: 1"=100'
 300'
 0 100 200
 0 100 200
 m, ft

QSG 250/PH 23

PIT 2N
 LUSCAR LTD.
 QUINSAM
 LINE NO. 90+00

DATE 25/08/78
 DRAWN BY: S.J.N.

MOGRAPHICAL 1" = 100'
 VERTICAL 1" = 100'

71
 L19
 QX-Quinsam 78(2)A

24

0 100 200 miles

QSG 237/PH 23

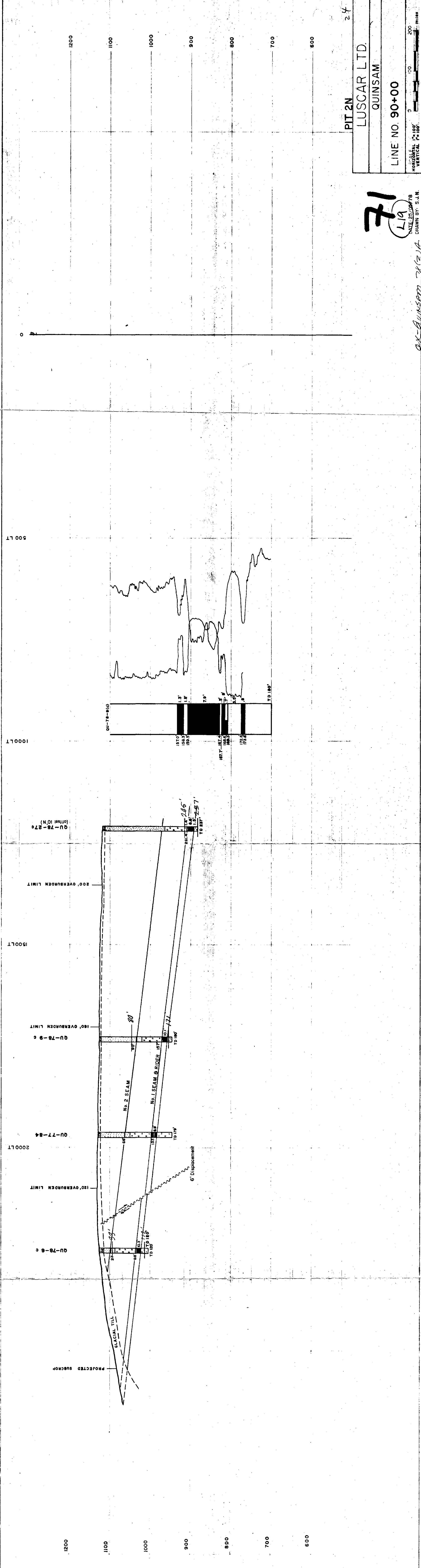

PIT 2 N
 LUSCAR LTD
 QUINSAM
 LINE NO. 85+00
 DATE: 25/05/78
 DRAWN BY: S.J.M.



EX-QUINSAM 28(2)A

VERTICAL 1" = 100'
 HORIZONTAL 1" = 200'

QSG 234/PH 25

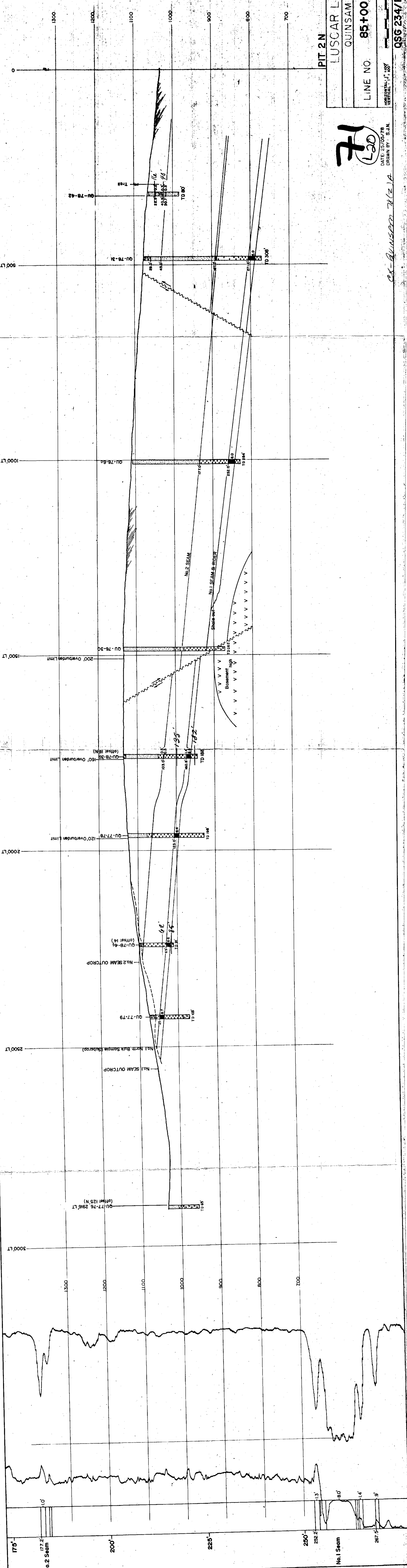

PIT 2N 2*
 LUSCAR LTD.
 QUINSAM
 LINE NO 82+50

71
 L21
 DATE: 25/05/78
 DRAWN BY S.J.N.

QSG 233/PH 23

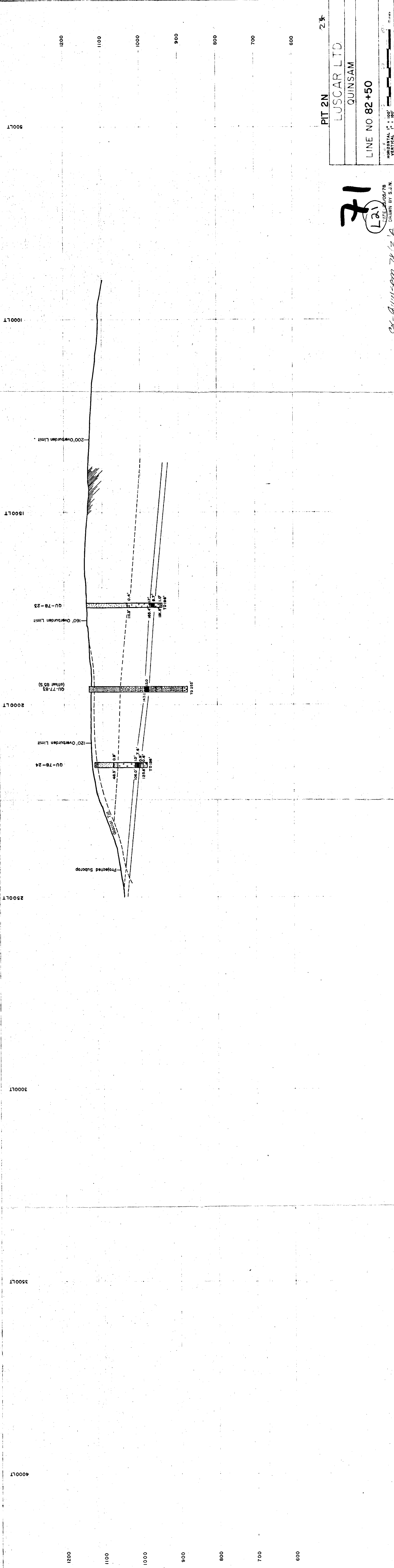

4000LT 3500LT 3000LT 2500LT 2000LT 1500LT 1000LT 500LT

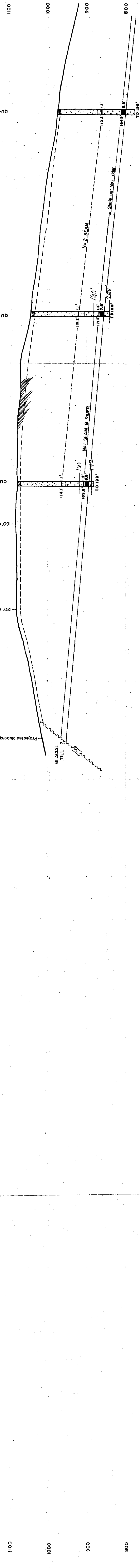

PIT 2N 24
 LUSCAR LTD.
 QUINSAM
 LINE NO. 75+00

71
 (122)

DATE 25/05/78
 DRAWN BY S.J.N.

EX-QUINSAM 2(2)A

HORIZONTAL 1"=100'
 VERTICAL 1"=100'

QSG 230/PH 23

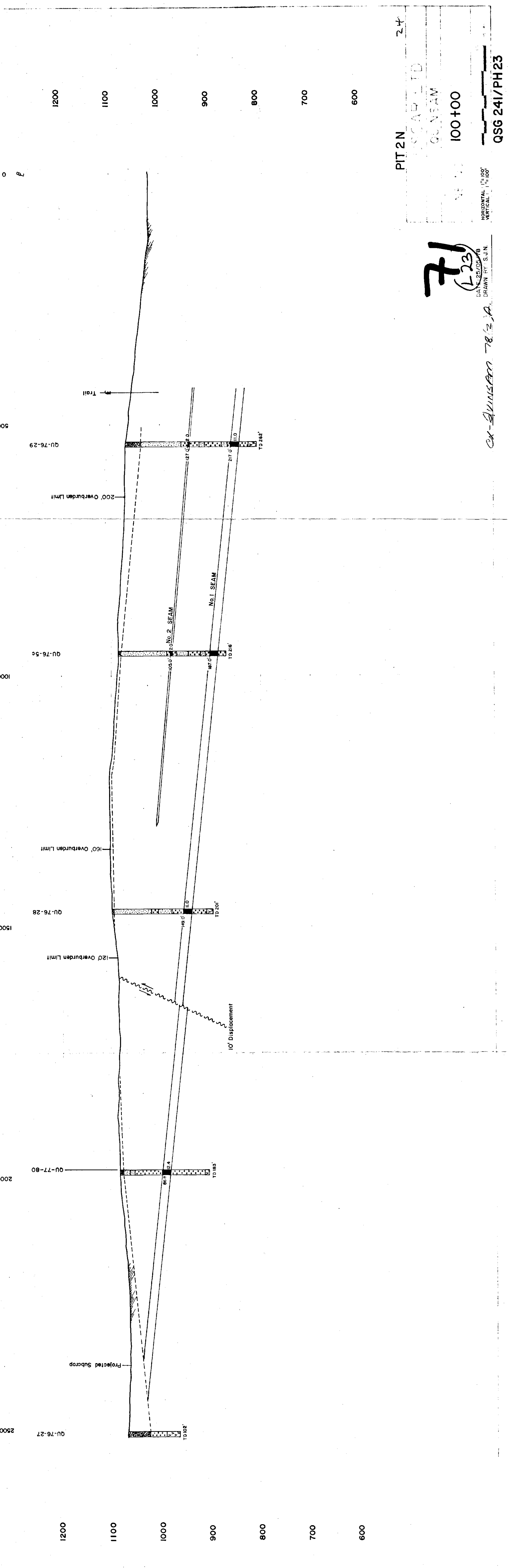

PIT 2N
 ESCAP LTD
 GUNSAM
 100+00

71
 (L23)
 DAN 125/05/8
 DRAWN BY S.J.N.
 EX-AMUNSAN 78 1/2 A

QSG 241/PH23

HORIZONTAL 1"=100'
 VERTICAL 1"=100'

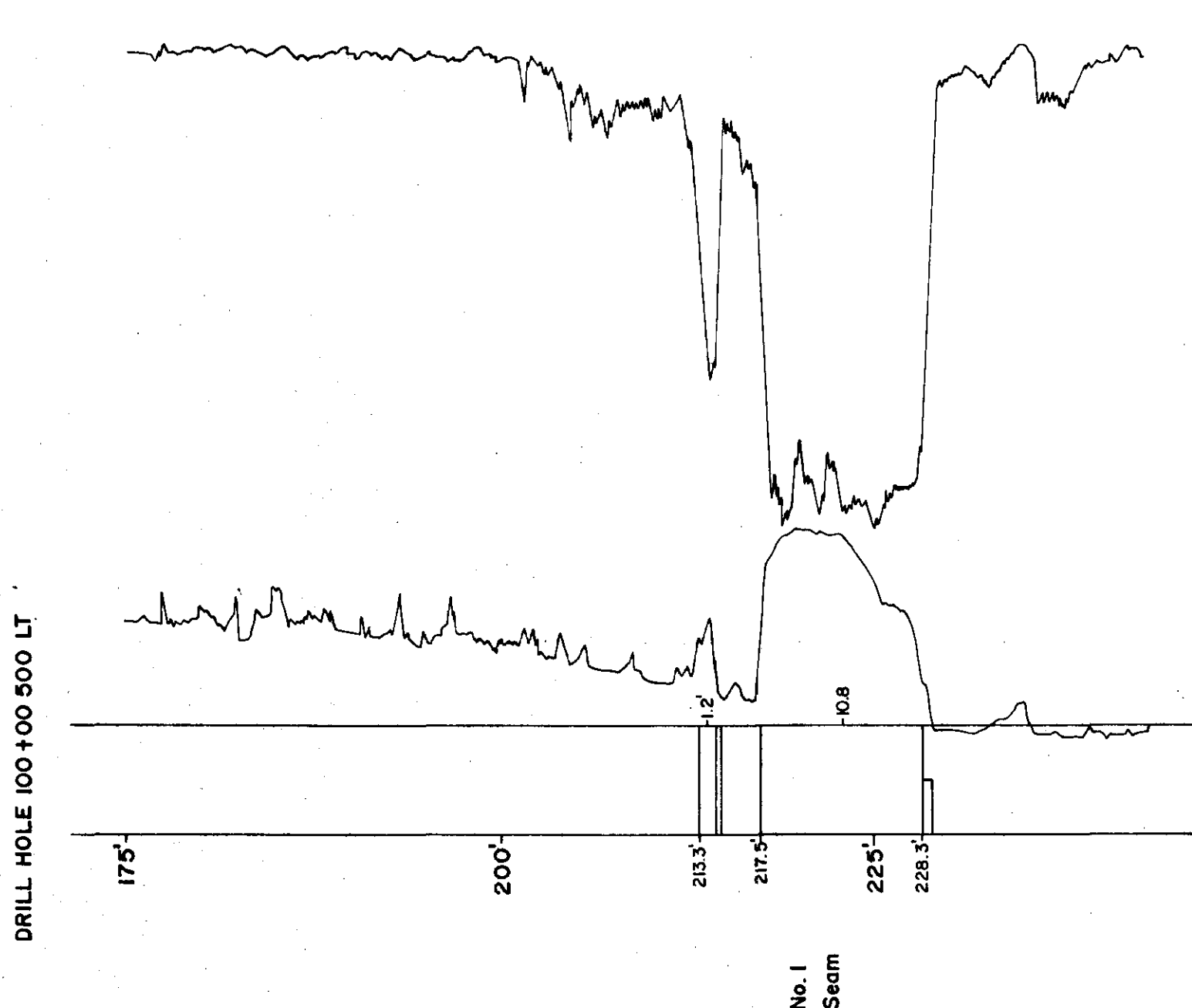

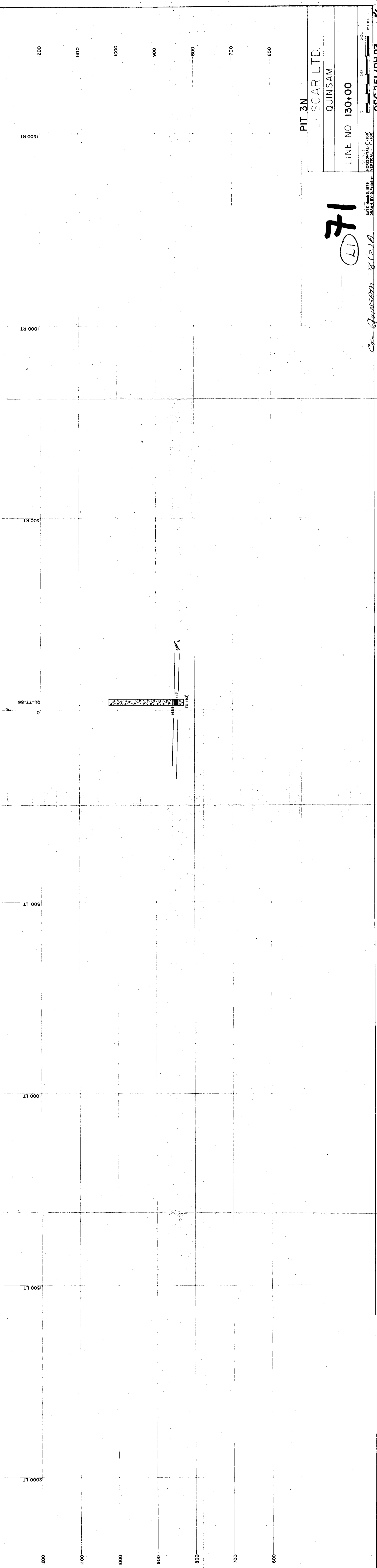

QU-77-86
4

10
TO 192

1083

117

500'

PIT 3N
SCAR LTD.
QUINSAM
LINE NO 130+00
SCALE
HORIZONTAL: 1"=100'
VERTICAL: 1"=20'
DATE: March 5, 1979
DRAWN BY: D. PAULIER
m/185

71
LI

CS-Quinsam 78 (2) A

QSG 251/PH 23

PIT 3N
 LUSCAR LTD.
 QUINSAM
 LINE NO 135100

71
 (L2)

DATE: July 10/78
 DRAWN BY: S.LT.SOENEN

ex-Quinsam - 1(2)A

HORIZONTAL 1" = 100'
 VERTICAL 1" = 20'
 QSG 252/PH23

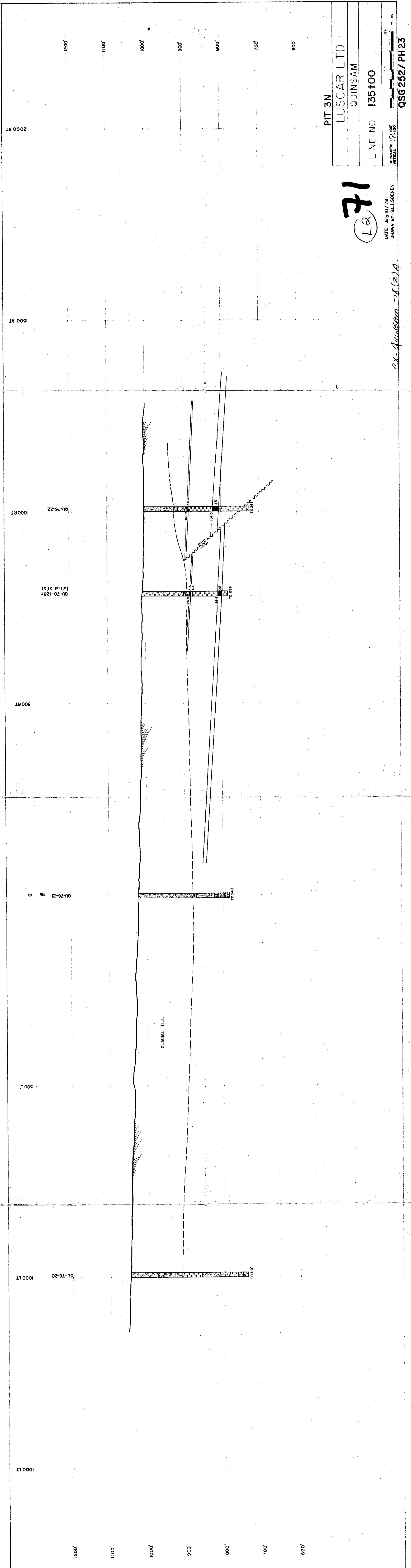

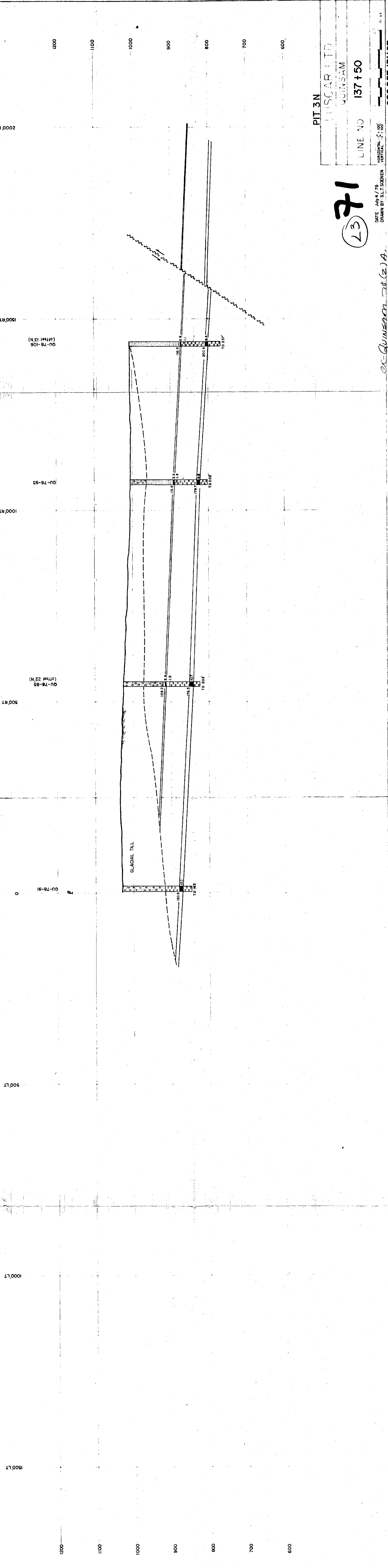

PIT 3N
 LUSCAR LTD
 QUINSAM
 LINE NO 137 + 50

2371

DATE: July 4/78
 DRAWN BY: S.L.T SOENEN
 VERTICAL SCALE: 1" = 100'

ex-Quinsam 20(2)A

QSG 253/PH23

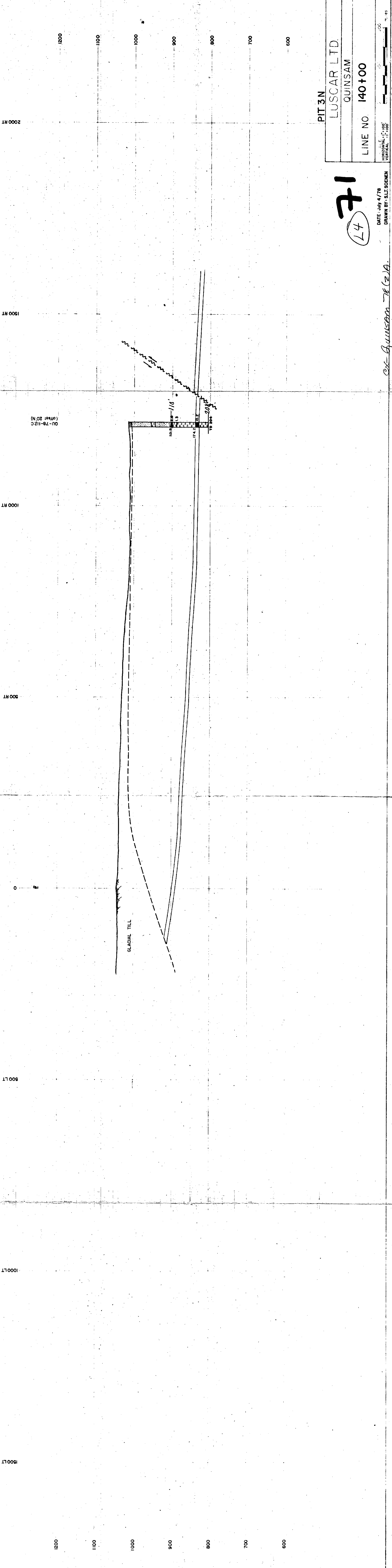

PIT 3N
 LUSCAR LTD.
 QUINSAM
 LINE NO 140+00

DATE: JULY 4/78
 DRAWN BY: S.LT. SOENEN

71
 (L4)

ex-Quinsam 78 (2)A.

QSG 254/PH23

QU-76-112C
 (offset 20 N)

GLACIAL TILL

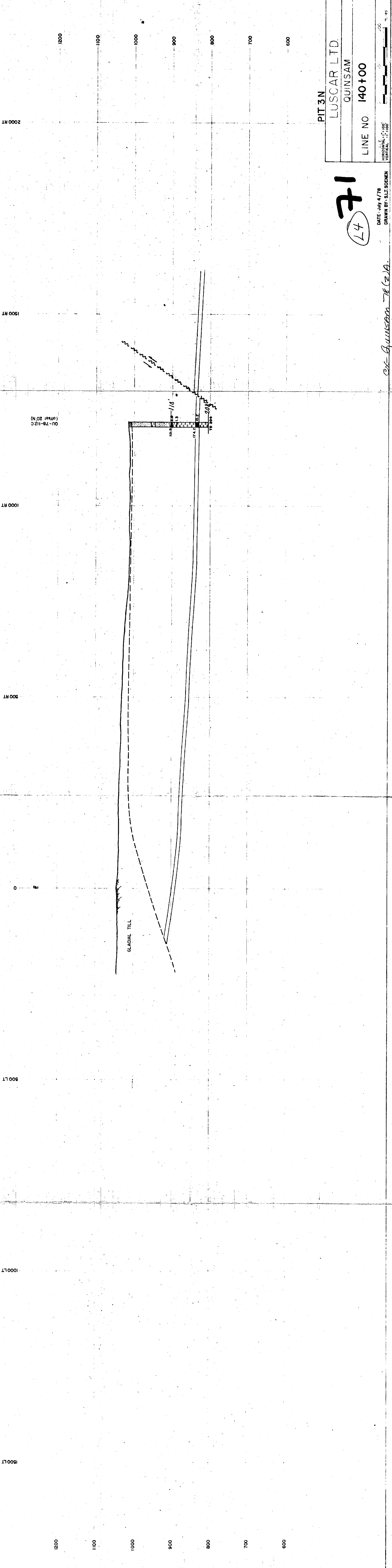

1200' 1100' 1000' 900' 800' 700' 600'

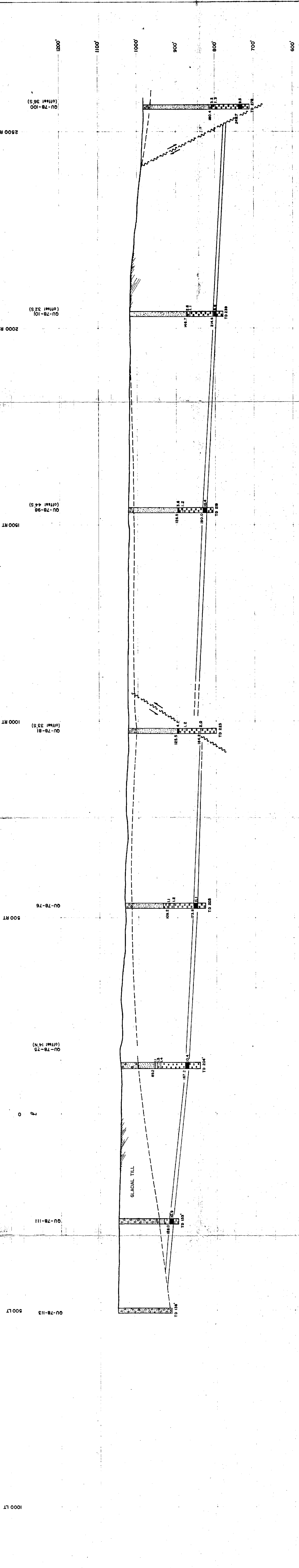

PIT 3N
 LUSCAR LTD
 QUINSAM
 LINE NO. 142+50

71
 LS

DATE: July 5 / 78
 DRAWN BY: S.L. SOENEN

ex: Quinsam (2) A

20' m. 100'
 HORIZONTAL: 1" = 100'
 VERTICAL: 1" = 100'

QSG 255/PH 23

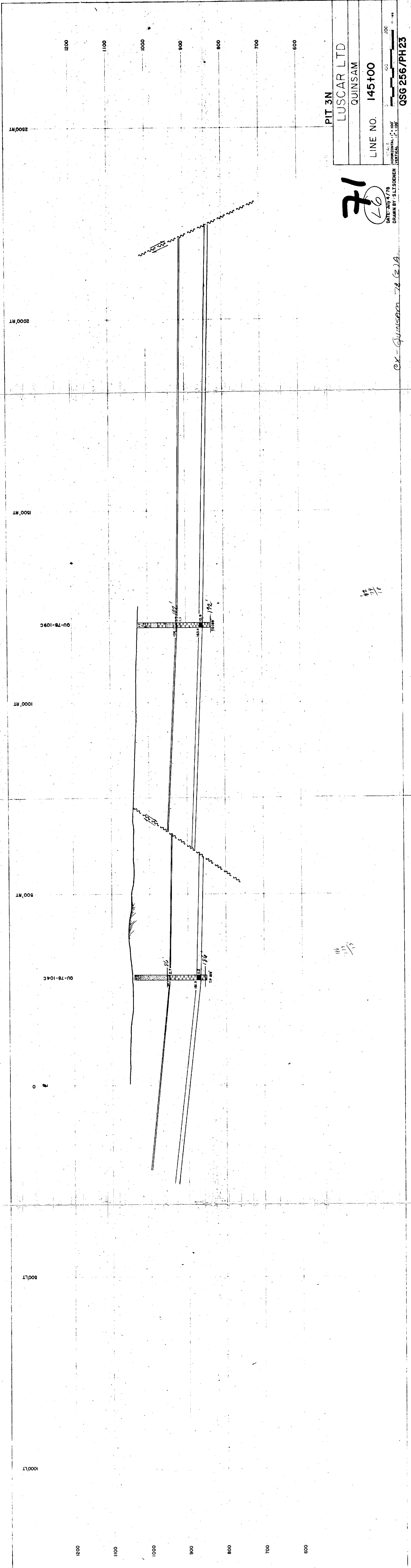

PIT 3N
 LUSCAR LTD
 QUINSAM
 LINE NO. 145+00

71
 16
 18

SCALE
 HORIZONTAL: 1" = 100'
 VERTICAL: 1" = 100'
 DATE: 3/17/78
 DRAWN BY: S.J. SOENEN

EX - Quinsam 78 (2)A

QSG 256/PH 23

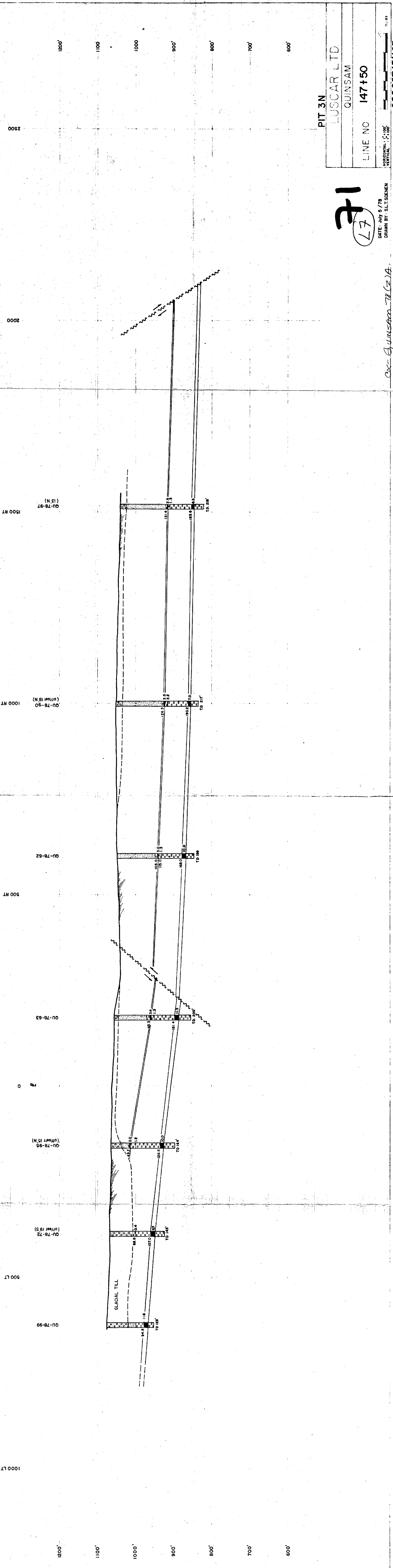

PIT 3N
 LUSCAR LTD
 QUINSAM
 LINE NO 147+50
 DATE: July 5/78
 DRAWN BY: S.L.T. SOENEN
 HORIZONTAL: 1" = 100'
 VERTICAL: 1" = 100'
 QSG 257/PH23
 71
 L7
 cx-Quinsam 78 (2)A

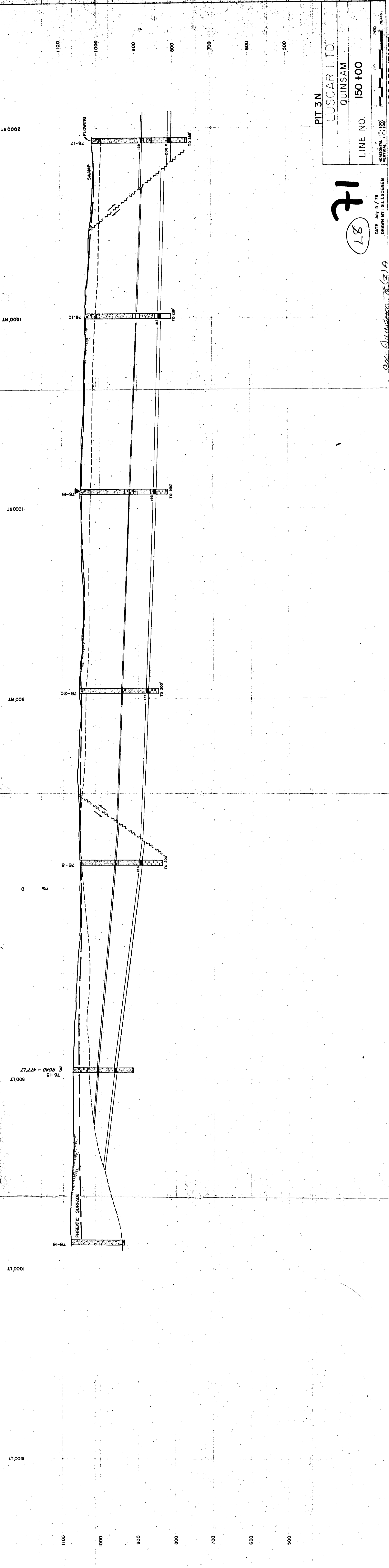

PIT 3N
 LUSCAR LTD.
 QUINSAM
 LINE NO. 150 100

171
 187

DATE: July 5 / 78
 DRAWN BY: S.LT. SOENEM

ex-Quinsam 78(z)A

HORIZONTAL: 1" = 100'
 VERTICAL: 1" = 100'
 200 Feet

QSG 258/PH23

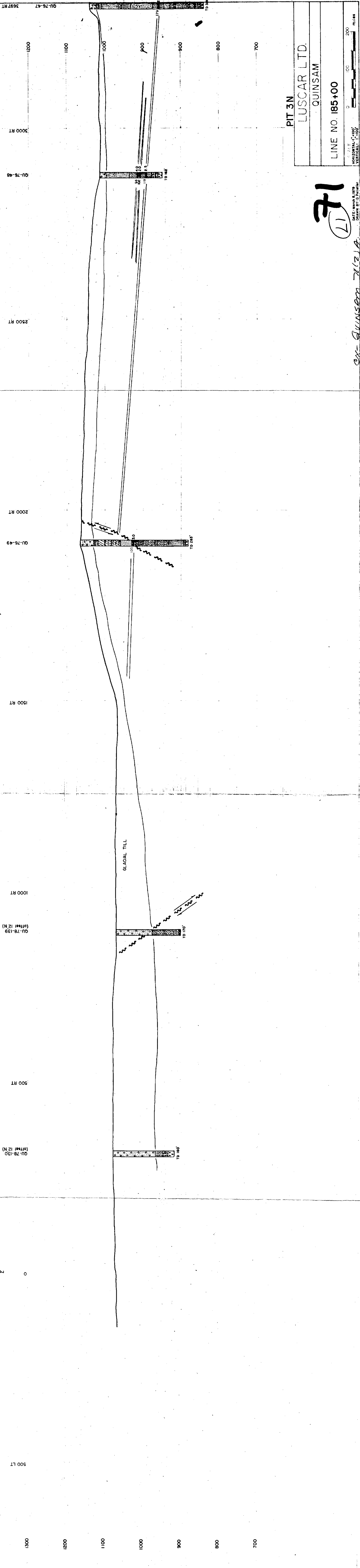

PIT 3N
 LUSCAR LTD.
 QUINSAM
 LINE NO. 185+00
 SCALE
 HORIZONTAL: 1"=100'
 VERTICAL: 1"=100'
 DATE: March 8, 1978
 DRAWN BY: D. J. F. J. J.

71

ex-Quinsam 78/21A
 QSG 271/PH23

PIT 3N
 LUSCAR LTD.
 QUINSAM
 LINE NO. 180 + 00

71
 L27

DATE: MAY 11/78
 DRAWN BY: S.L. SOENEN

CX-QUINSAM 28(2)A

HORIZONTAL: 1" = 100'
 VERTICAL: 1" = 100'
 0 100 200
 miles

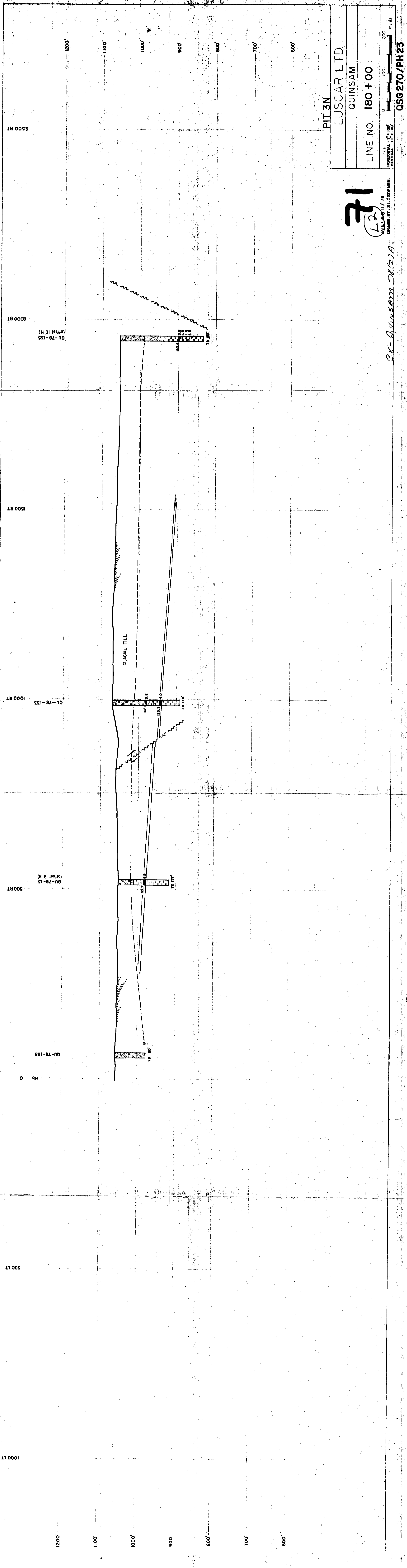

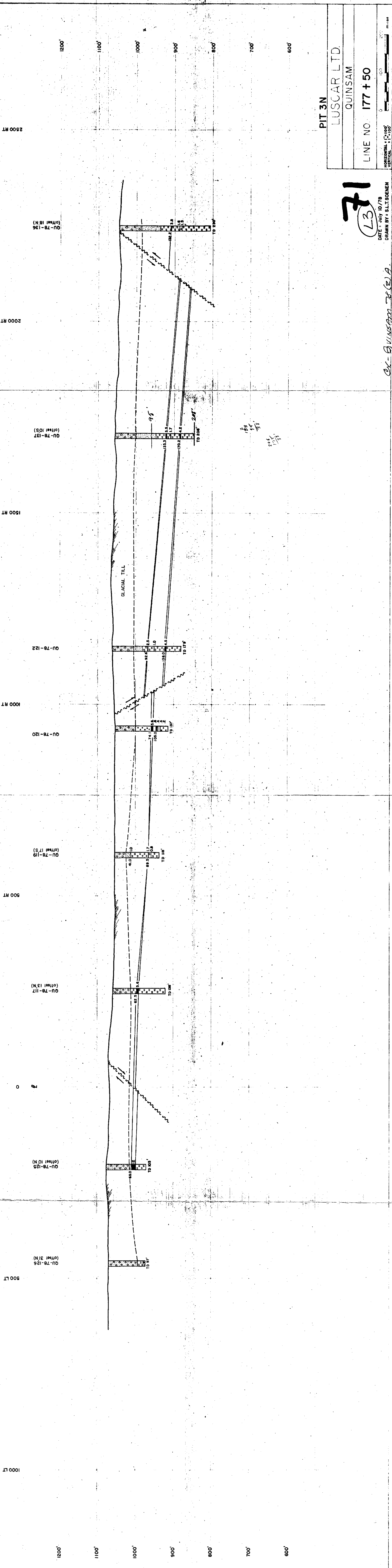

PIT 3N

LUSCAR LTD.
QUINSAM

LINE NO. 177 + 50

HORIZONTAL: 1" = 100'
VERTICAL: 1" = 100'

DATE: July 10/78
DRAWN BY: S.L.T. SOESEN

71
L3

OK - Quinsam 78 (2) A

QSG 2697/PH23

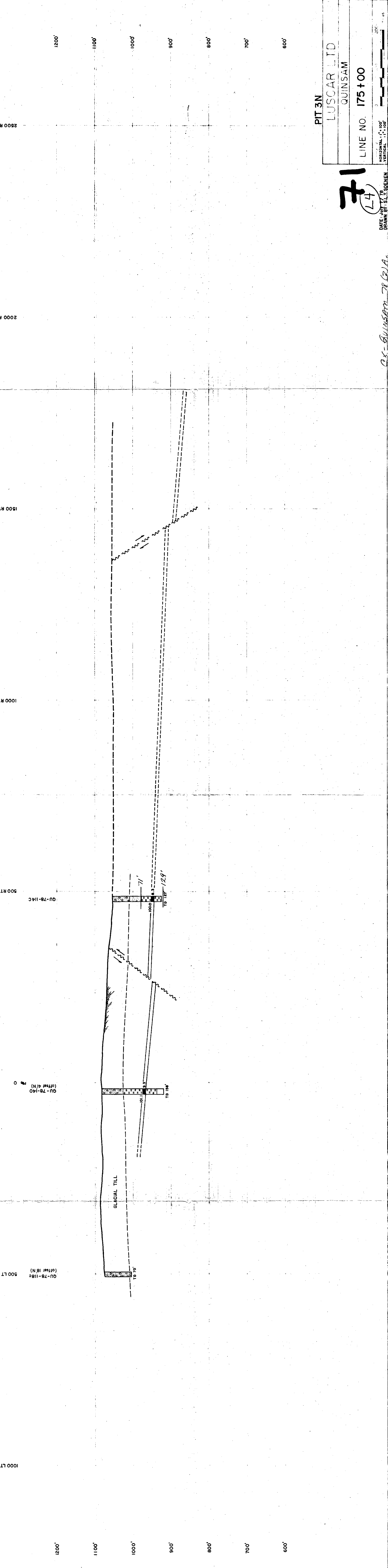

PIT 3N
 LUSCAR LTD
 QUINSAM
 LINE NO. 175+00
 DATE: JUN 17 78
 DRAWN BY: S.T. SOENEN
 HORIZONTAL: 1"=100'
 VERTICAL: 1"=20'
 QSG 268/PH23

71
 L4

C.K. - QUINSAM 78 (P) A

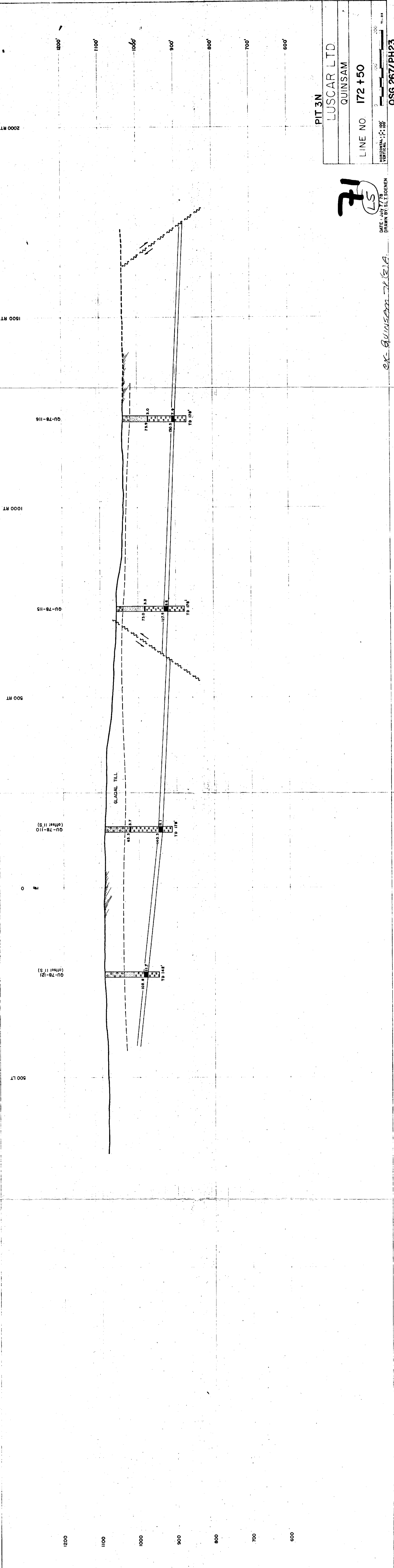

PIT 3N
 LUSCAR LTD.
 QUINSAM
 LINE NO. 172 +50

LS
 F

DATE: JULY 27, 1986
 DRAWN BY: S.L. SOENEN

ex- QUINSAM 71(2)A

0 100 200
 HORIZONTAL: 1" = 100'
 VERTICAL: 1" = 100'
 0 100 200
 FEET
 METERS

QSG 2677/PH23

DRILLHOLE 170+00

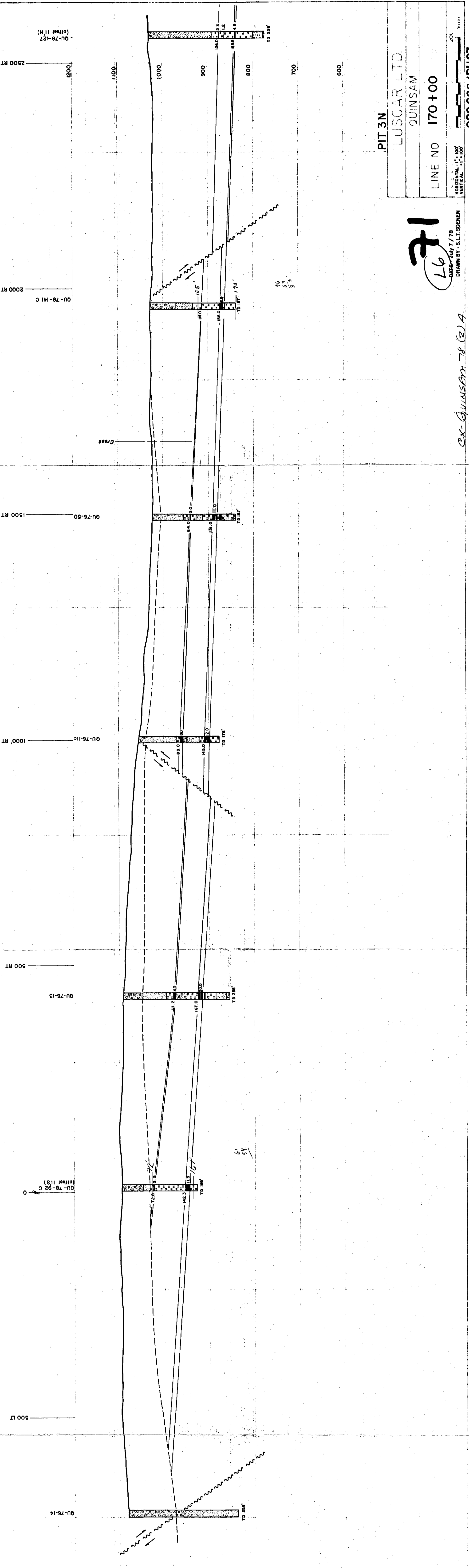
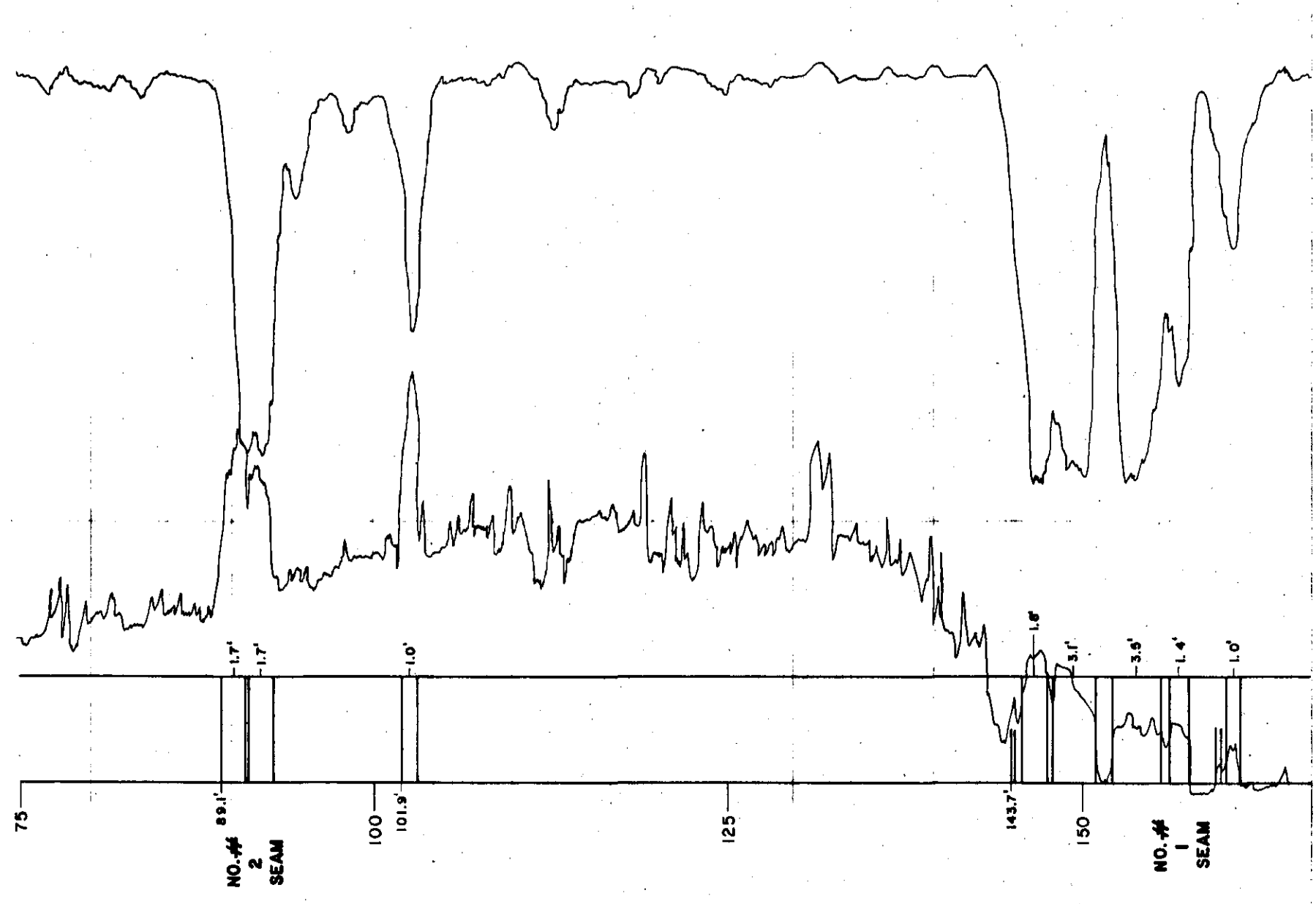

71
L6

EX-QUINSAM 78 (2) A

QSG 266/PH23

PIT 3N
 LUSCAR LTD.
 QUINSAM
 LINE NO. 167 + 50

DATE: July 7 / 78
 DRAWN BY: S.L.T. SOENEN

CX- QUINSAM 78 (2)A

71
 L7

HORIZONTAL: 1" = 100'
 VERTICAL: 1" = 100'

2500 RT 2000 RT 1500 RT 1000 RT 500 RT 0 500 LT 1000 LT

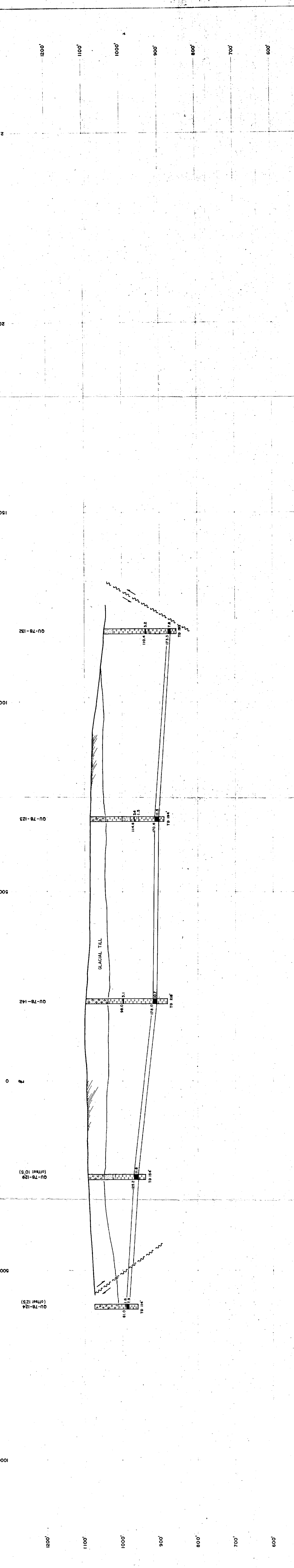

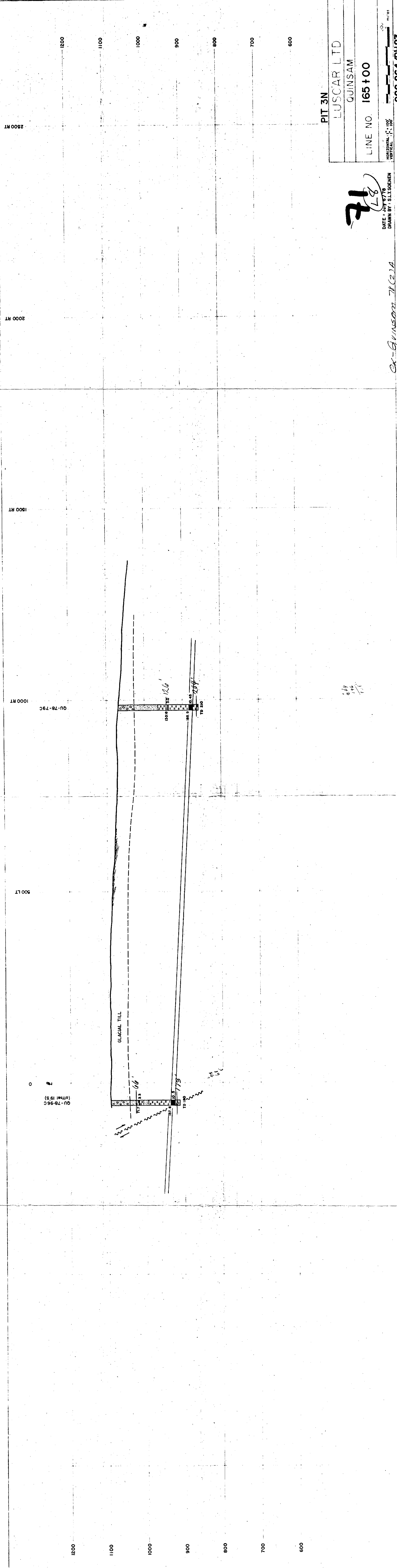

PIT 3N
 LUSCAR LTD
 QUINSAM
 LINE NO. 165 + 00

DATE: JUL 27/78
 DRAWN BY: S.L. SOENEN



CR-Quinson 78(2)A

QSG 264/PH23

PIT 3N
 LUSCAR LTD.
 QUINSAM
 LINE NO. 162 + 50

71
 (L9)

DATE: JULY 6/78
 DRAWN BY: S.L.T. SOEREN

QUINSAM 78 (2) A

QSG 263/PH 23

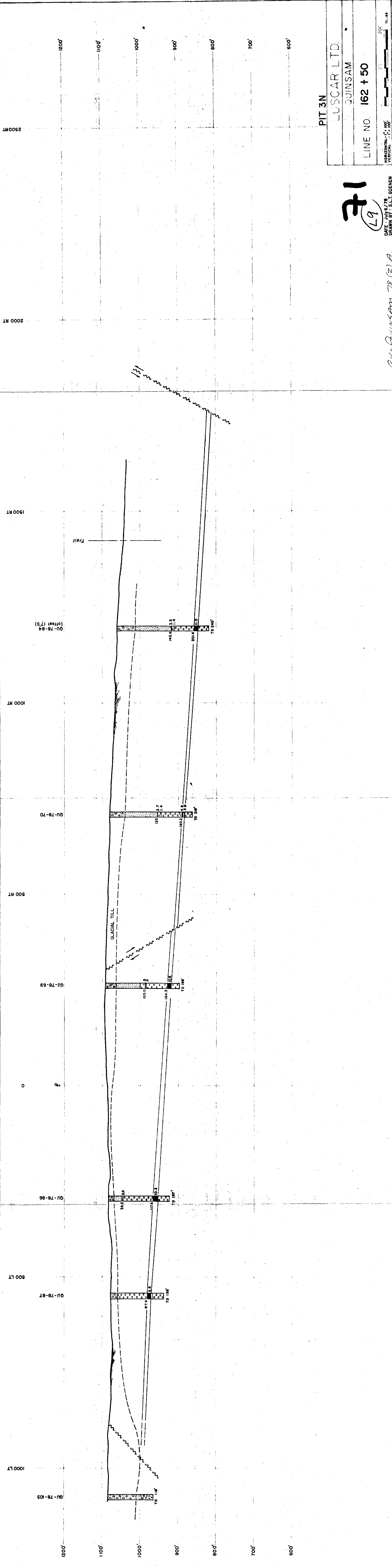

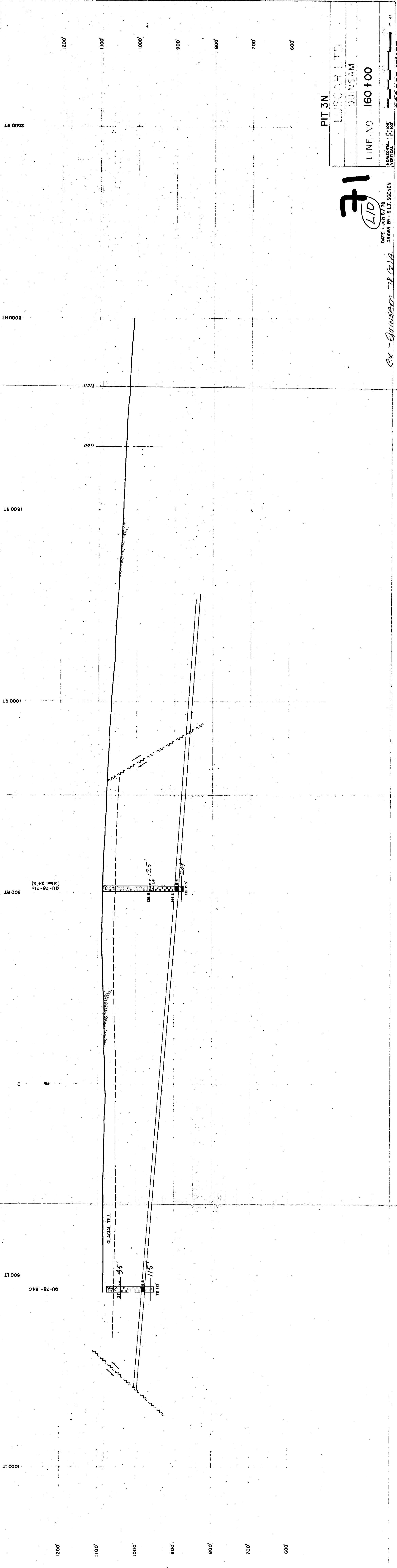

PIT 3N
 LUSCAR LTD
 QUINSAM
 LINE NO 160+00

71
 L10

DATE: JULY 6/78
 DRAWN BY: S.L.T. SOENEN

EX - QUINSAM 78 (2) A

HORIZONTAL: 1" = 100'
 VERTICAL: 1" = 100'

QSG262/PH23

PIT 3N
 LUSCAR LTD.
 QUINSAM
 LINE NO 155+00
 2/2

71
 (11)

DATE: JULY 6/78
 DRAWN BY: S.L.T. SOENEN

HORIZONTAL 1" = 100'
 VERTICAL 1" = 100'
 200' m. 1:85

Ex-Quinsam 79 (2)A

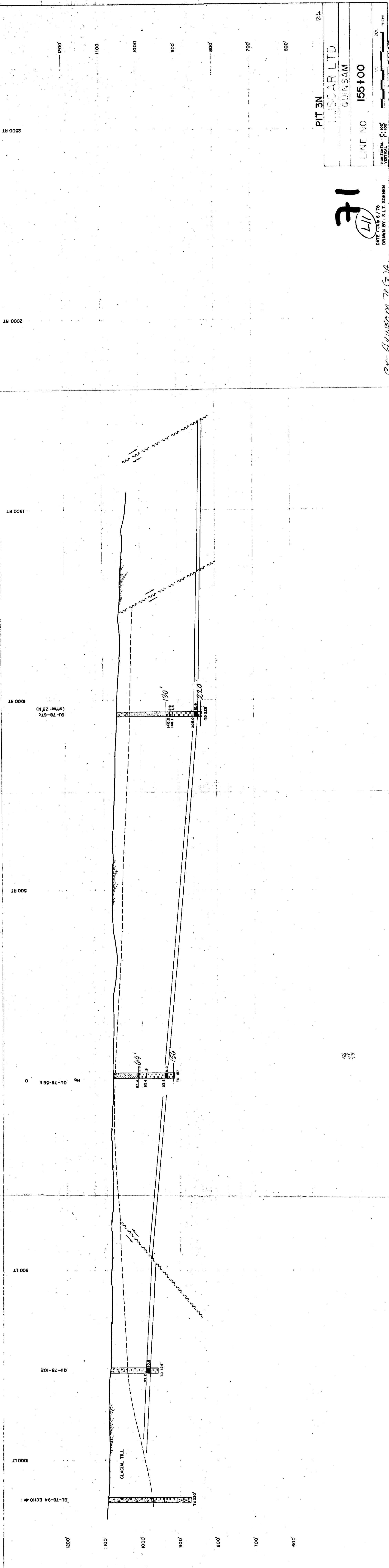

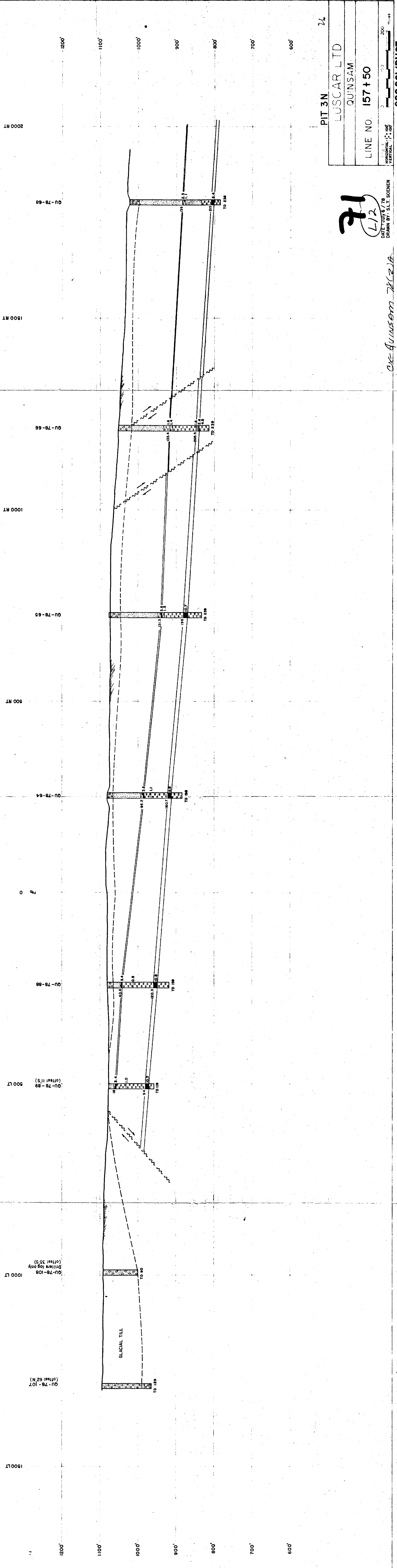

PIT 3N 24

LUSCAR LTD

QUINSAM

LINE NO. 157 + 50

HORIZONTAL: 1" = 100'

VERTICAL: 1" = 100'

DATE: 10/18/78

DRAWN BY: S.L.T. SOENEN

CSG 261/PH23

71

L12

OK - Quinsam 2/2/78

PIT 3N 26

LUSCAR LTD.

QUINSAM

LINE NO 152 + 50

DATE: 00/07/79
DRAWN BY: S.L.T.SOENEN

71
L13

CK: Quinsam 28 (2) A

QSG 259/PH23

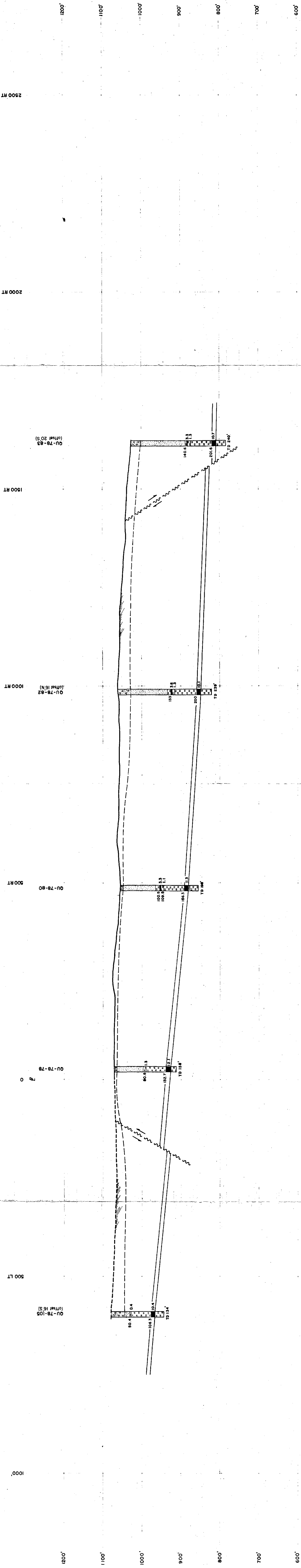

PITSI, 2&3 S

50+00

NO. 50+00

HORIZONTAL 1"=100'
VERTICAL 1"=100'

QSG 226/PH 23

DATE: Sept. 21, 1978
DRAWN BY: R. Volinco
C.E. Gunnstrom

71

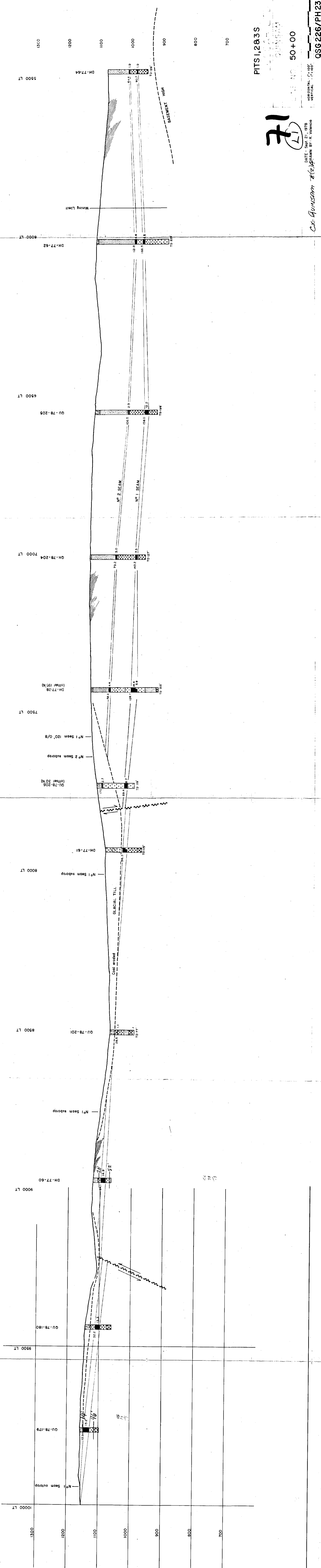

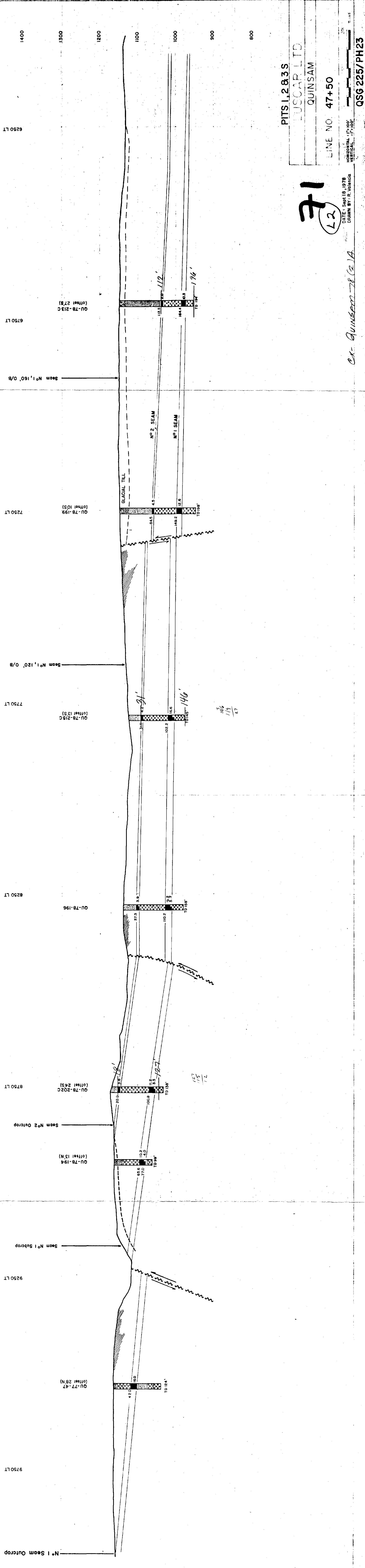

71
 L2

DATE: Sept 18, 1978
 DRAWN BY: R. Valencia
 HORIZONTAL: 1" = 100'
 VERTICAL: 1" = 100'

EX-QUINSAM-78 (2) A
 QSG 225/PH23

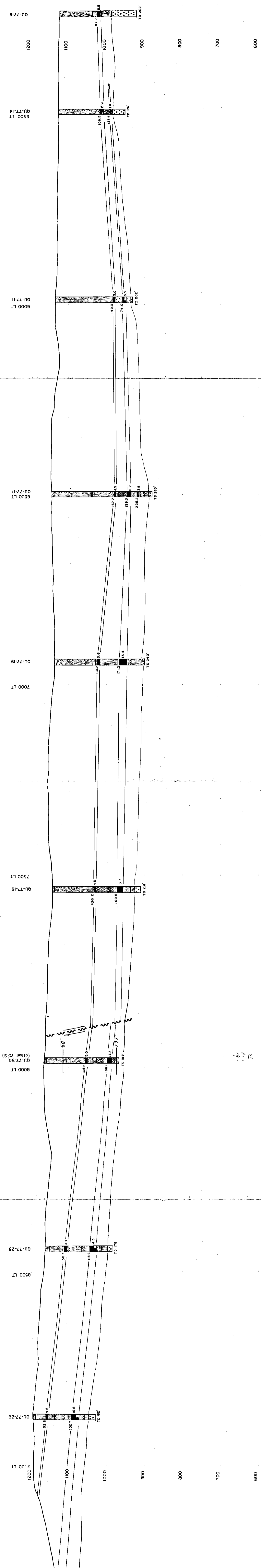

PITS 1,283S
 OSCAR LTD.
 QUINSAM
 LINE NO. 45+00
 HORIZONTAL 1:100
 VERTICAL 1:100
 DATE 12/19/73
 QUINSAM 78(z)A

71
 L3

1/4
 1/4
 75

DATE 12/19/73
 QUINSAM 78(z)A

QSG 224/PH 23

DATE: October 3, 1978
 DRAWN BY: R. Videncio

LINE NO 55+00

PITS 1, 2 & 3 S

71
 L4

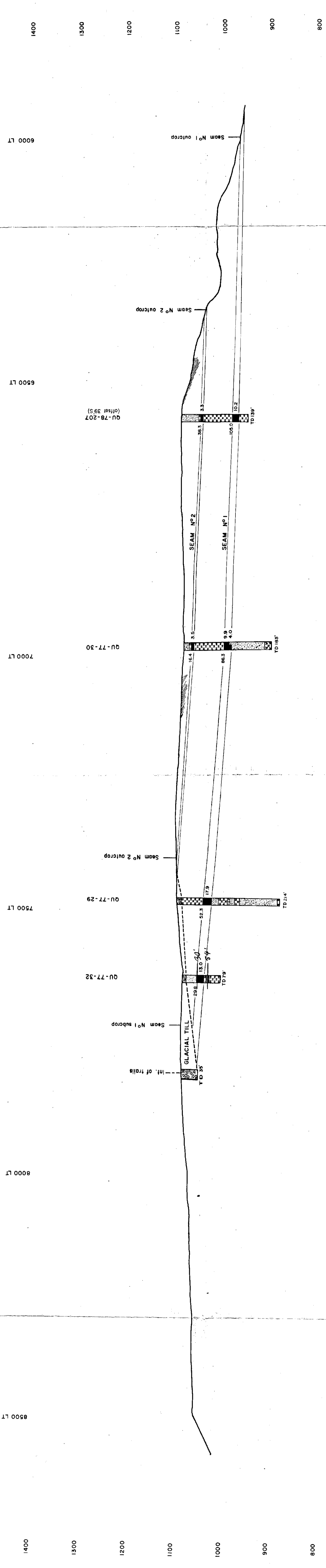

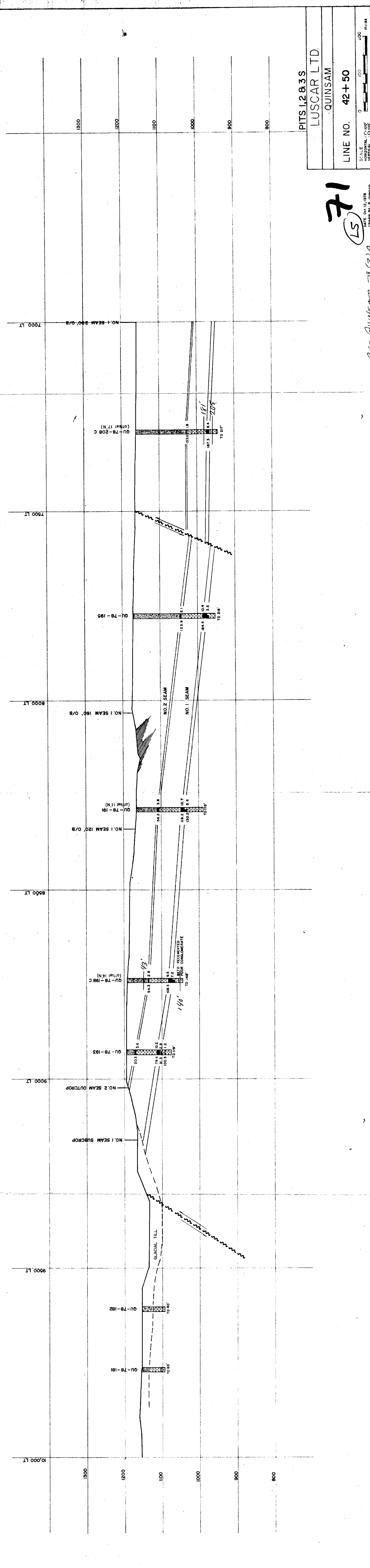

PITS 1,2 & 3 S
 LUSCAR LTD.
 QUINNSAM

71
 LS

LINE NO. 42+50

SCALE
 HORIZONTAL 1"=100'
 VERTICAL 1"=100'



DATE: Oct 12, 1978
 DRAWN BY: R. VONBAGO

QUINNSAM 78 (2) A

71
 (L6)

DATE 25.12.87
 DRAWN BY D. PHILLIPS

OK QUINSAM - 11 (2) A

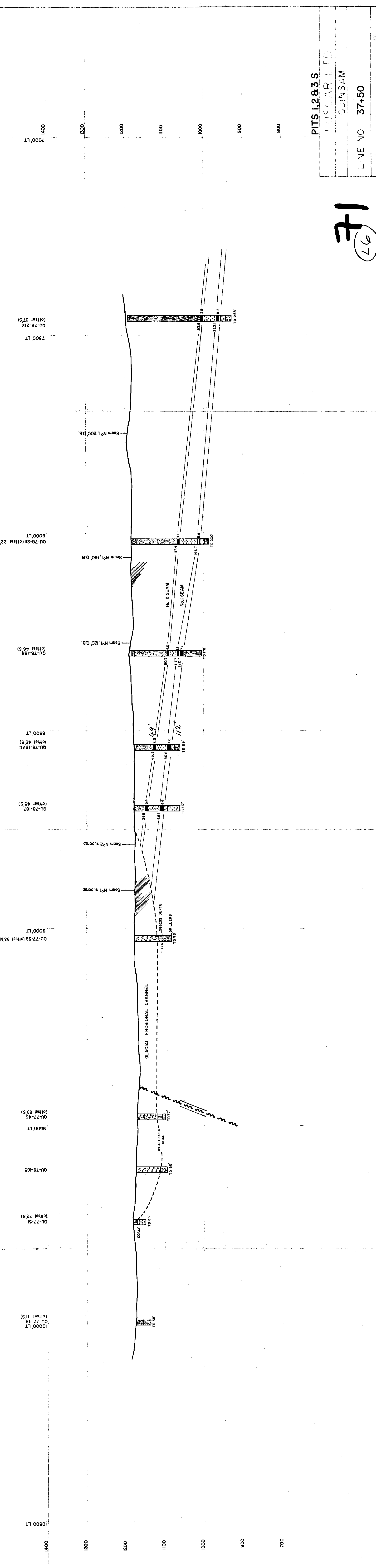

DATE: Feb 14, 1979
DRAWN BY: D. Peltier

SCALE:
HORIZONTAL: 1" = 100'
VERTICAL: 1" = 100'

LINE NO. 40+00

QUINSAM

LUSCAR LTD.

PITS 1,2,8,3S

71
L7

EX-QUINSAM-78(2)A

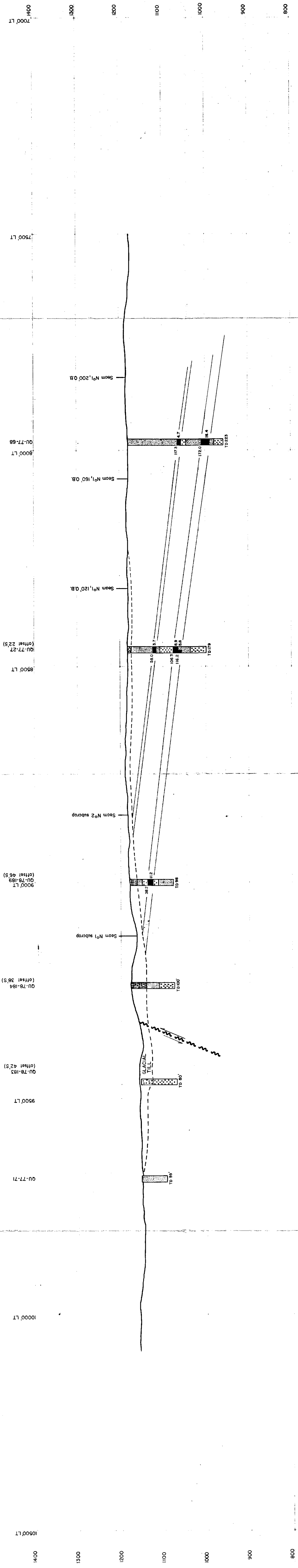

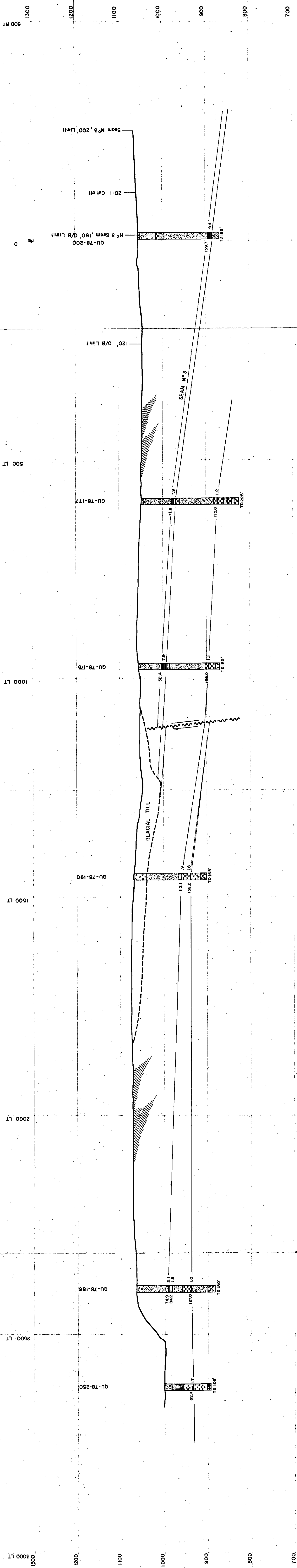

PITS 586S
 LUSCAR LTD
 QUINSAM
 LINE NO 45+00

71
 (22)

DATE: Sep-24-1978
 DRAWN BY: R. Videncio

ex- Avulsion & C/LA

HORIZONTAL: 1"=100'
 VERTICAL: 1"=100'

QSG 291/PH23

DATE: March 1979
DRAWN BY: D. P. HARRIS

HORIZONTAL: 1" = 100'
VERTICAL: 1" = 100'

CC 200

LINE NO 29+00

QUINSAM

LUSCAR LTD.

PITS 586S

71
L3

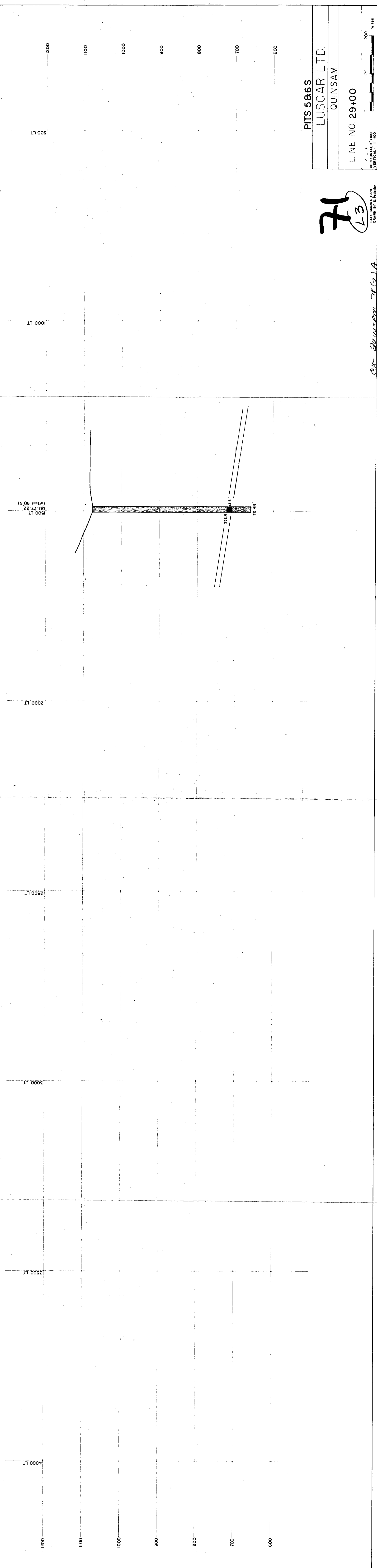

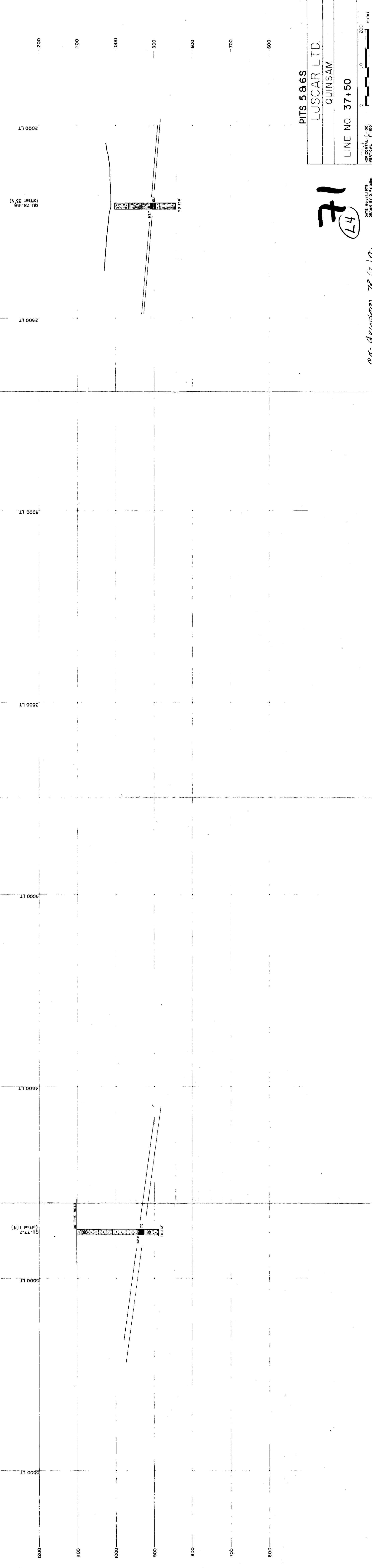

QU-77-7
(offset 11 N)

5500 LT

5000 LT

4500 LT

4000 LT

3500 LT

3000 LT

2500 LT

1200

1100

1000

900

800

700

600

PITS 5 8 6 S

LUSCAR LTD.

QUINSAM

LINE NO. 37+50

71
(L4)

DATE: March 1979
DRAWN BY: D. Palmer

QU-78-156
(offset 33 N)

VERTICAL: 1" = 100'
HORIZONTAL: 1" = 100'

0 100 200
miles

QUINSAM 78 (2) A

QSG 287/PH23

1200
1100
1000
900
800
700
600

2500 LT
2000 LT
1500 LT
1000 LT
500 LT
0
500 RT
1000 RT



PITS 5 & 6 S
LUSCAR LTD.
QUINSAM
LINE NO. 38+50

LS
7

DATE: March 1, 1978
DRAWN BY: G. MILLER

HORIZONTAL: 1" = 100'
VERTICAL: 1" = 500'
200
100
0
100
200
mills

EX-Quinsam 78(2)A

QSG 288/PH 23

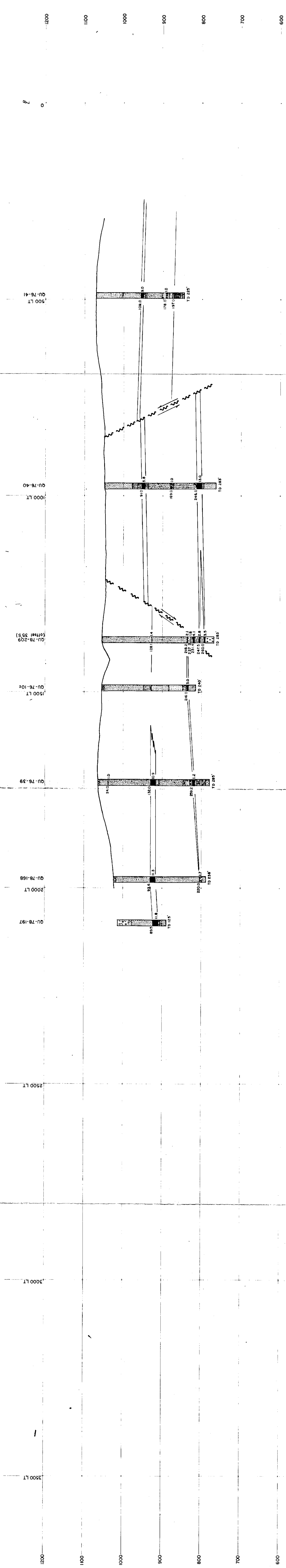

P
O

PITS 5 & 6 S
LUSCAR LTD.
QUINSAM
LINE NO. 40+00

71
L6

DATE: March 2, 1979
DRAWN BY: D. Phillips

ex-Quinsam 78(2)A

HORIZONTAL: 1" = 100'
VERTICAL: 1" = 100'

0 50 100 200
MILES

QSG 289/PH 23

DATE: 10/25/1978
 DRAWN BY: R. Volinico

HORIZONTAL: 1"=100'
 VERTICAL: 1"=100'

71 (L7)



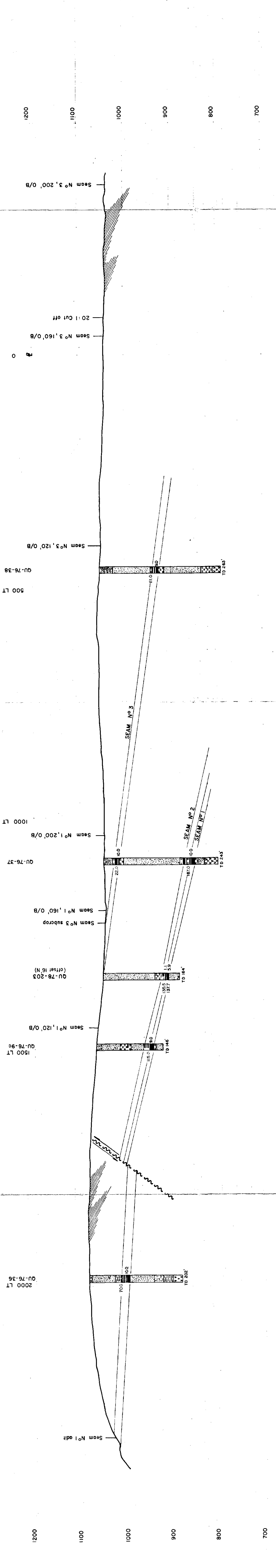
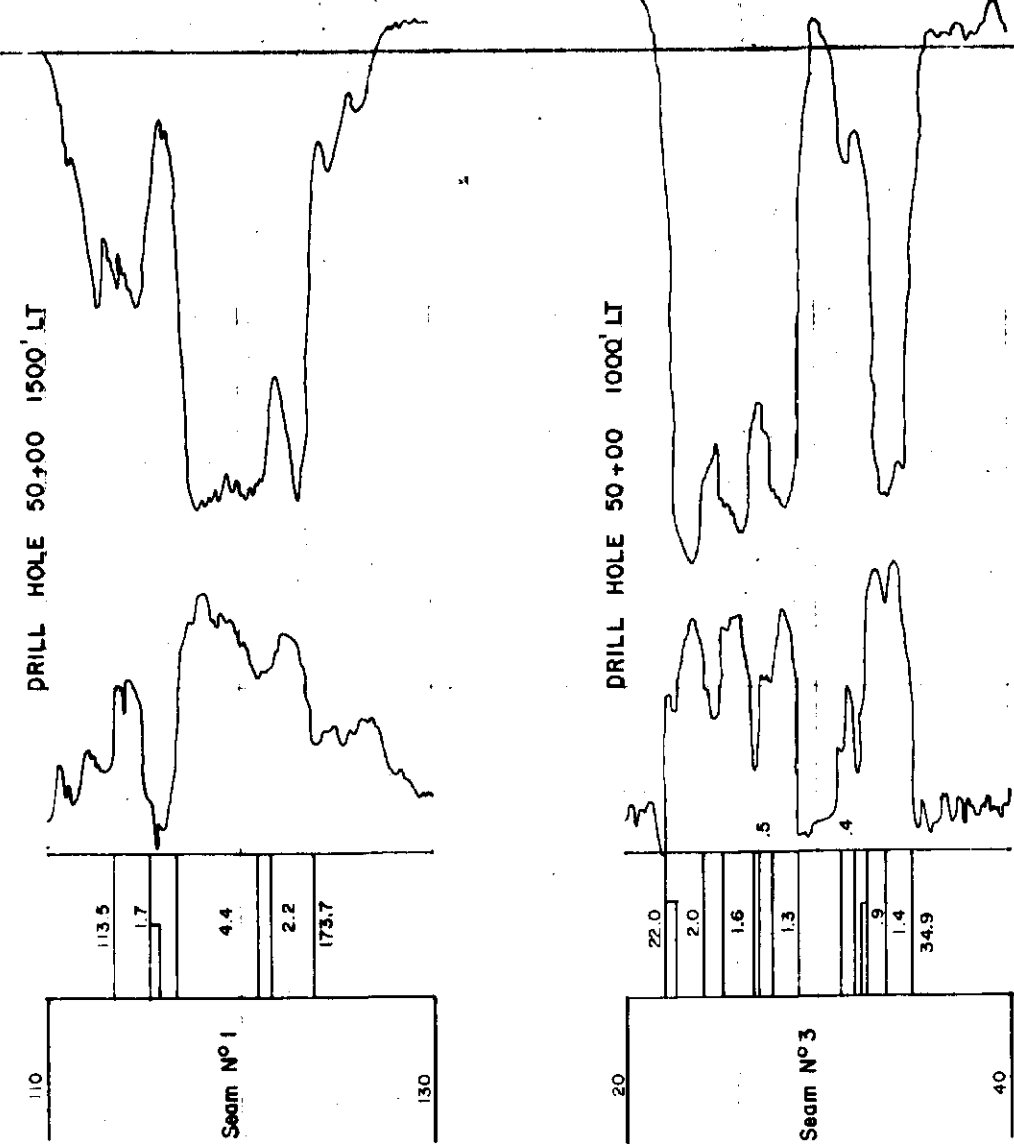

PITS 58.6S
LUSCAR LTD.
QUINSAM
LINE NO 50+00

71
L8



DATE: October 2, 1978
DRAWN BY: R. Valencia

ex. Quinsam 71 (2)A

QSG 293/PH23

7500 LT

8000 LT

8500 LT

9000 LT

9500 LT

10000 LT

1400

1300

1200

1100

1000

900

1400

1300

1200

1100

1000

900

OUTCROP
OUTCROP (CATTED OUT)
OUTCROP

PITS 5 8 6 S

QUINSAM

LINE NO. 52+50

(L9) 71

DATE OCTOBER 24 1978
DRAWN J GRAYSON

CR-Quinsam 78 (2) 1A

VERTICAL SCALE 1" = 100'
HORIZONTAL SCALE 1" = 100'

200'

QSG 294/PH23

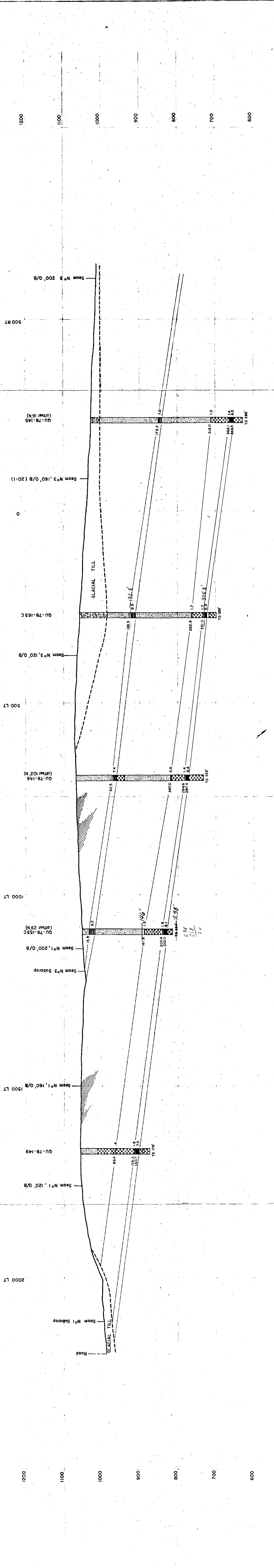

PITS 586S
 LUSCAR LTD.
 QUINSAM
 LINE NO 55+00
 HORIZONTAL: 1" = 100'
 VERTICAL: 1" = 100'

71
 LIO
 DATE: Sep 21, 1978
 DRAWN BY: R. Valencia

EX- QUINSAM 71 (2) A.

1100
1000
900
800
700
600
500

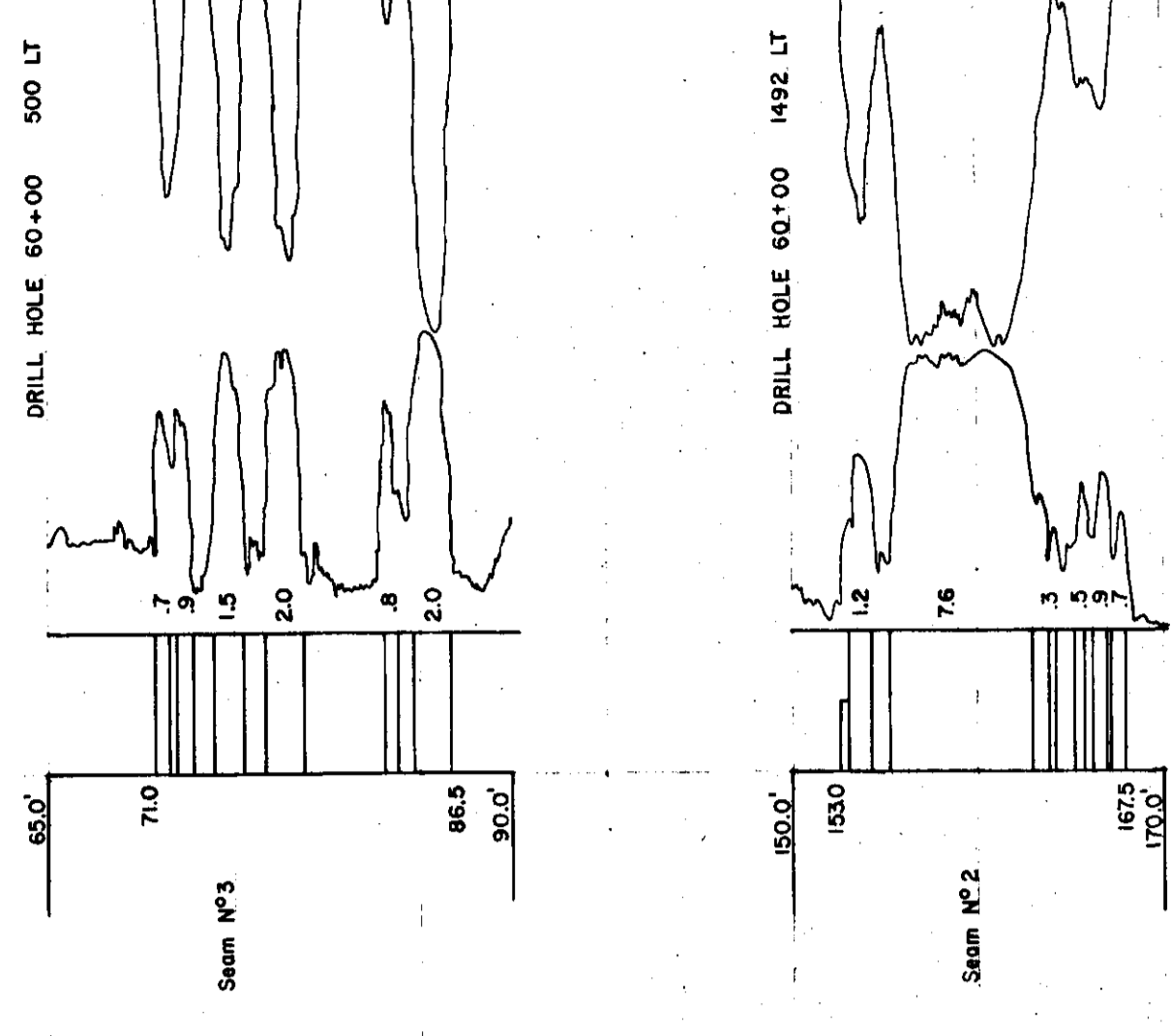
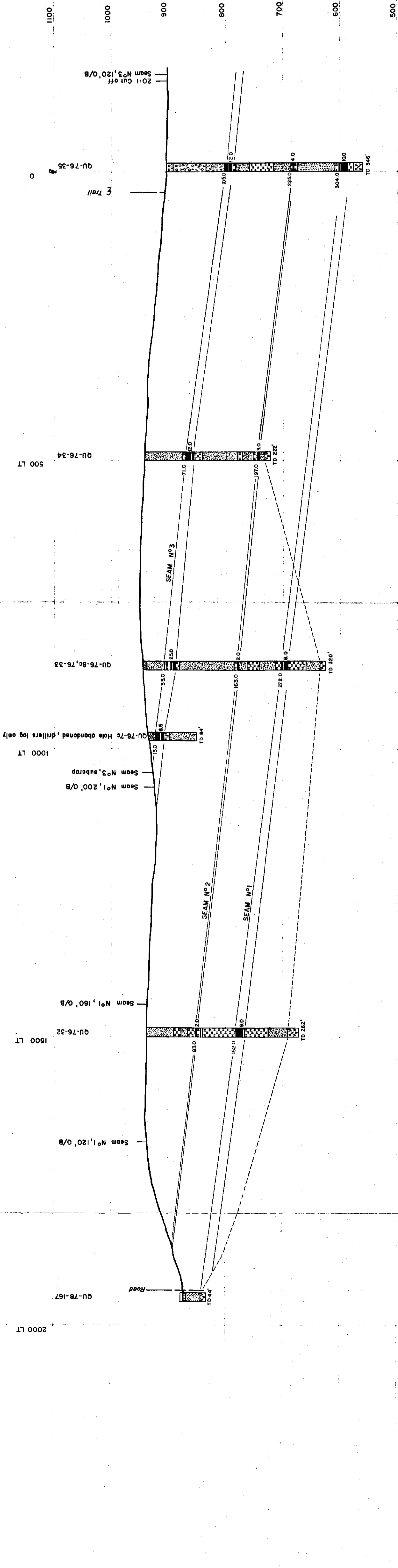

PITS 5&6 S
 LUSCAR LTD
 QUINSAM
 60+00

71
 LII

DATE: September 28, 1978
 DRAWN BY: R. Valencia
 HORIZONTAL: 1"=100'
 VERTICAL: 1"=100'

ex-Quinsam 71 (2) A

QSG 296/PH23

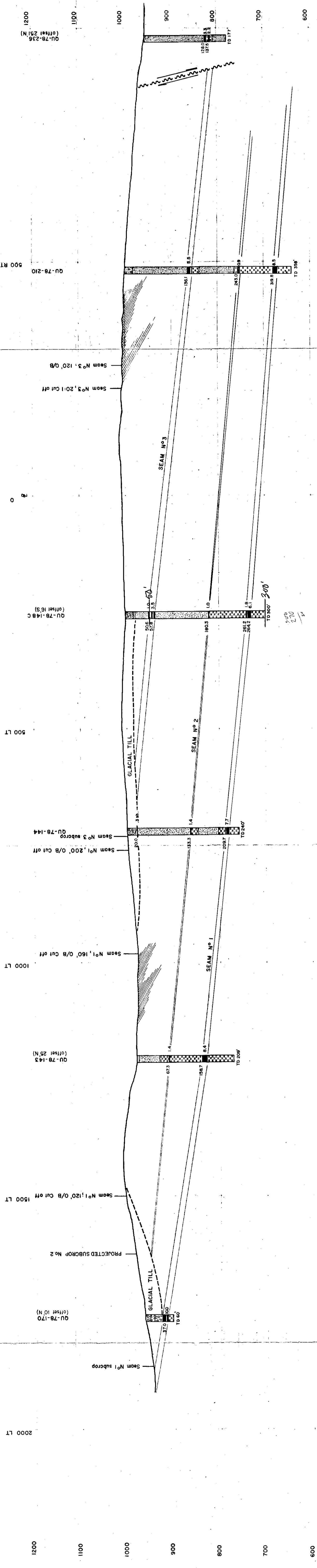

PITS 5 & 6 S
 LUSCAR LTD
 QUINSAM

LINE NO 62 + 50

DATE: September 30, 1978
 DRAWN BY: R. Valencia

HORIZONTAL: 1" = 100'
 VERTICAL: 1" = 100'

EX- QUINSAM 7K(2)A

QSG 297/PH23

DATE: Feb. 16, 1979
DRAWN BY: D. Pambier

HORIZONTAL: 1"=100'
VERTICAL: 1"=100'

46+00

QSG 306/PH 23

17
31

PIT 7

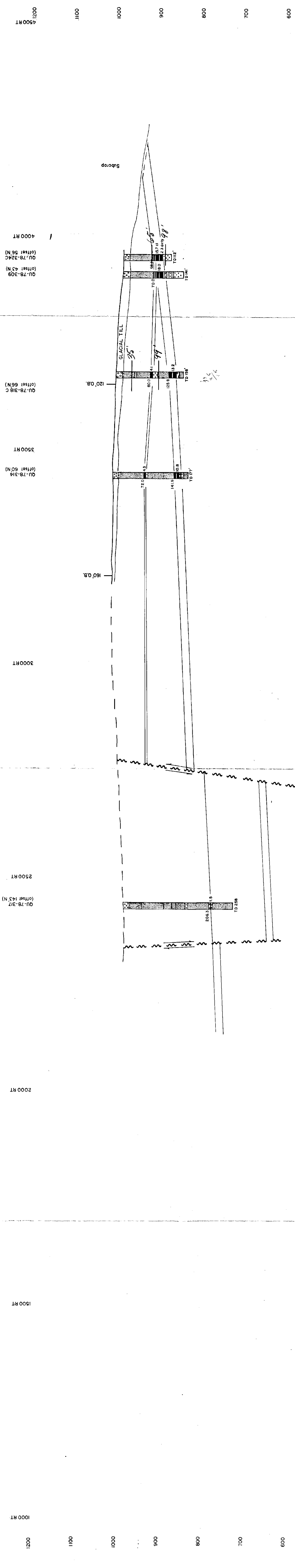

ex-Quinson 74(2)A

1200
1100
1000
900
800
700
600

1200 RT
1100 RT
1000 RT
900 RT
800 RT
700 RT
600 RT

1500 RT
1000 RT
500 RT
0

QU-78-303
200 O.B.
160 O.B.
120 O.B.
Subcrop

QU-78-300
2000 RT

QU-78-302
1200 RT

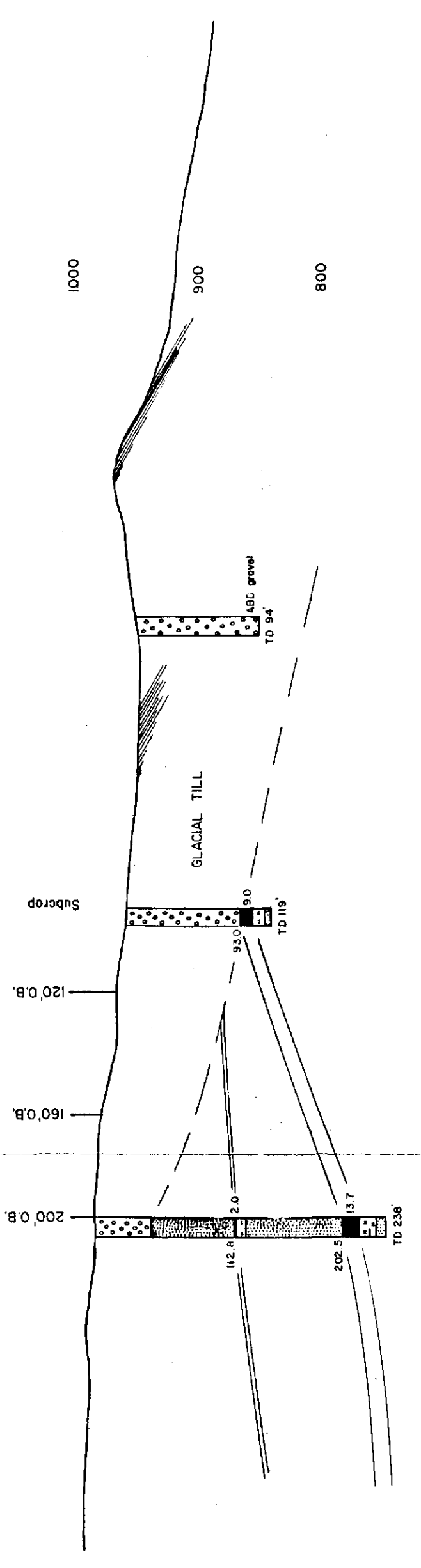

PIT 7

71
L2

25+00

EX-Quinsam 71 (2) A.

HORIZONTAL 1"=100'
VERTICAL 1"=100'

DATE: Feb. 19, 1979
DRAWN BY: P. Fisher
QSG 302/PH 23

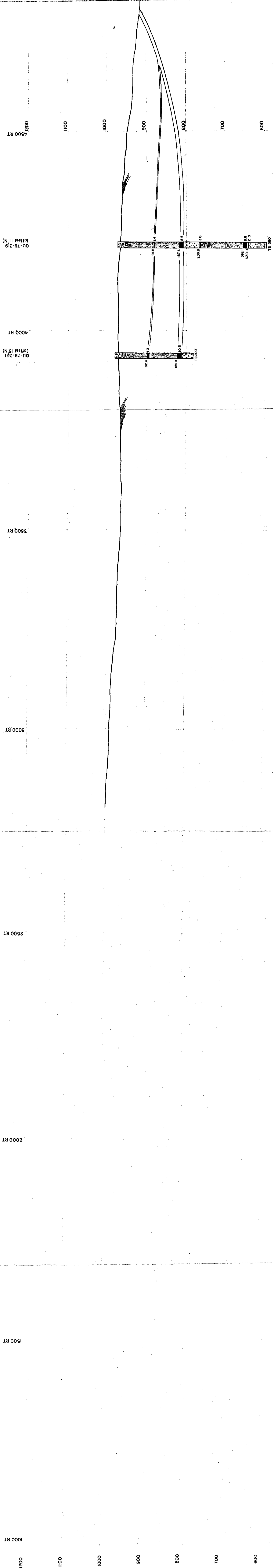

PIT 7

71
L3

59+00

DATE: Feb 16, 1979
DRAWN BY: D. Peirner

HORIZONTAL: 1"=100'
VERTICAL: 1"=100'

EX- Gunsem 78 (2) A

QSG 309/PH 23

OU-78-222
(offset 26 S)
3500 RT

3000 RT

2500 RT

2000 RT

1500 RT

1000 RT

500 RT

4000 RT

1000

ON THE ROAD

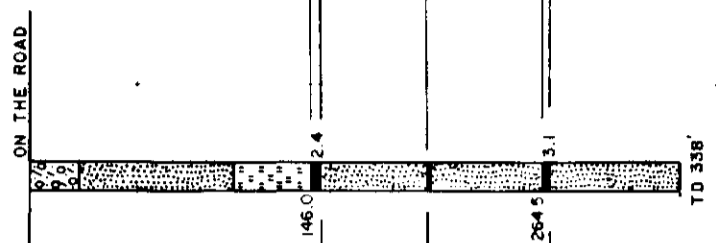

900

800

700

600

500

400

PIT 7
LUSCAR LTD
QUINSAM
LINE NO 70+00

71
LH

DATE: March 7, 1979
DRAWN BY: D. P. Miller

OK - Quinsam 28 (2) A

HORIZONTAL: 1"=100'
VERTICAL: 1"=100'



QSG 3107/PH 23

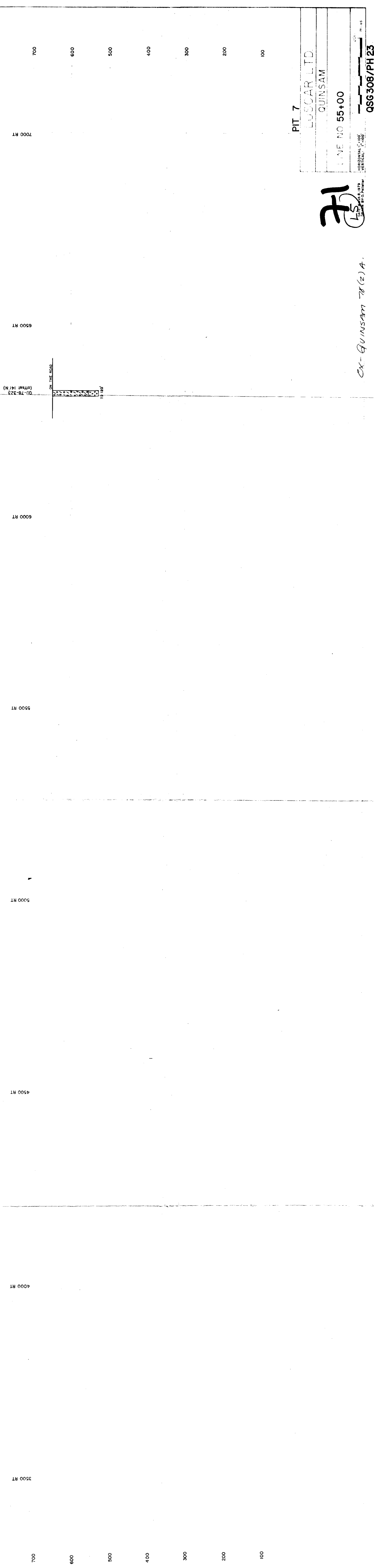

QU-78-323
(offset 141 N)

ON THE ROAD

141 180'

PIT 7
LUSCAR LTD.
QUINSAM
LINE NO 55+00



FLS
ENGINEERING
DALLAS, TEXAS

HORIZONTAL CURVE
VERTICAL CURVE
SCALE

EX-QUINSAM 78(2)A

QSG 308/PH 23

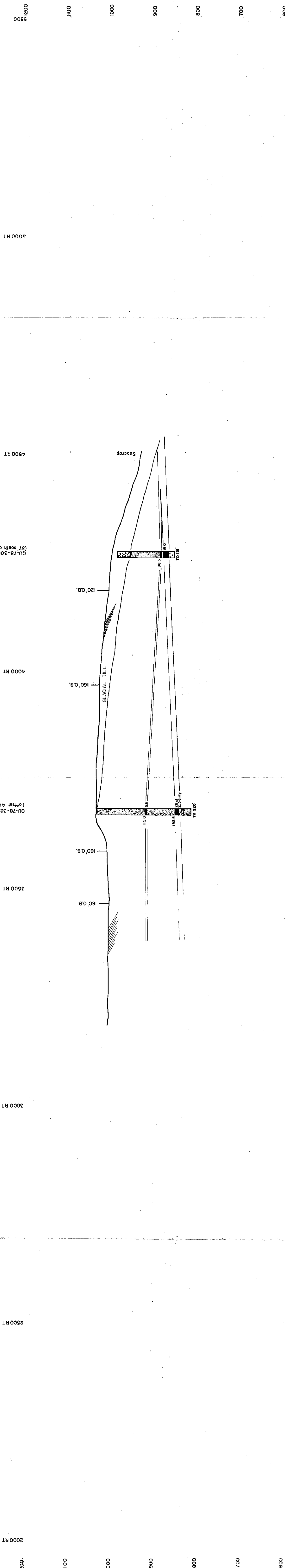

PIT 7
 LUGGARD LTD
 WUNSAM

71
 L6

DATE: Feb 16, 1979
 DRAWN BY: D. PHILLIPS

ex-BUNSAM 78 (2) A

HORIZONTAL: 1"=100'
 VERTICAL: 1"=100'

QSG 307/PH23

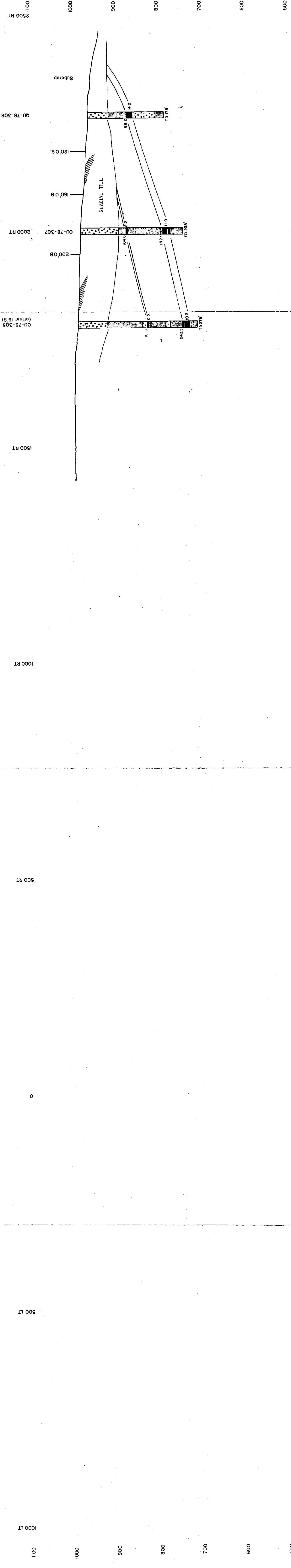

PIT 7 29

QU-78-308

LINE NO 30+00

71
L7

ex-GUNSAM N12JA

HORIZONTAL: 1"=100'
VERTICAL: 1"=100'

QSG 303/PH 23

PIT 7 29

LUSCAR LTD
QUINSAM

LINE NO 35+00

HORIZONTAL 1"=100'
VERTICAL 1"=100'

DATE: 14.12.1979
DRAWN BY: D. PAULINER

71
LS

EX-QUINSON 2 (3) A

QSG 304/PH23

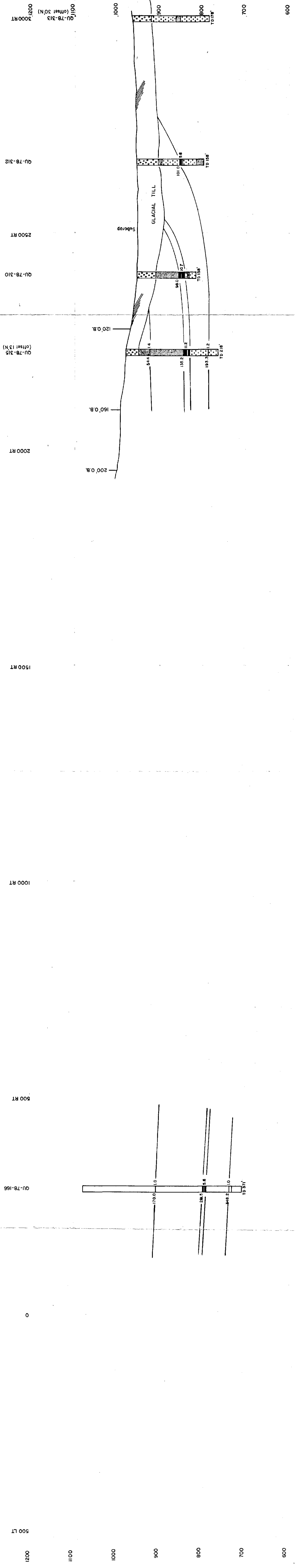

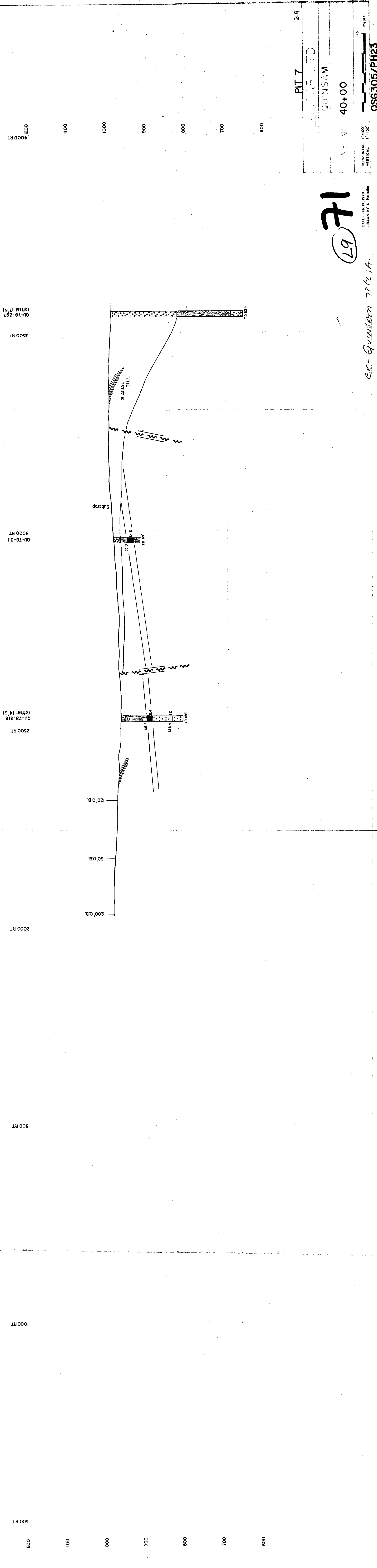

71
 (L9)

DATE Feb 19, 1979
 DRAWN BY D. Peirhofer
 ex-Gunnsam 71(2)A

PIT 7 29
 QUINSAM LTD
 QUINSAM
 NE NO 40+00
 HORIZONTAL 1"=100'
 VERTICAL 1"=100'
 QSG305/PH23

1100
1000
900
800
700
600
500

2500 RT

3000 RT

3500 RT

QU-78-326
(Offset 46N)

4000 RT

4500 RT

5000 RT

QU-78-325
(Offset 129S)

5500 RT

6000 RT

1100

1000

900

800

700

600

500

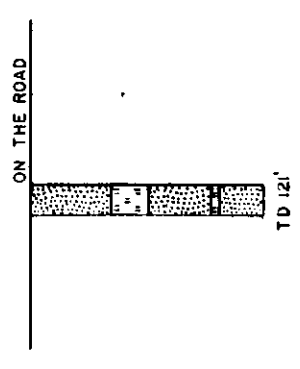

ON THE ROAD

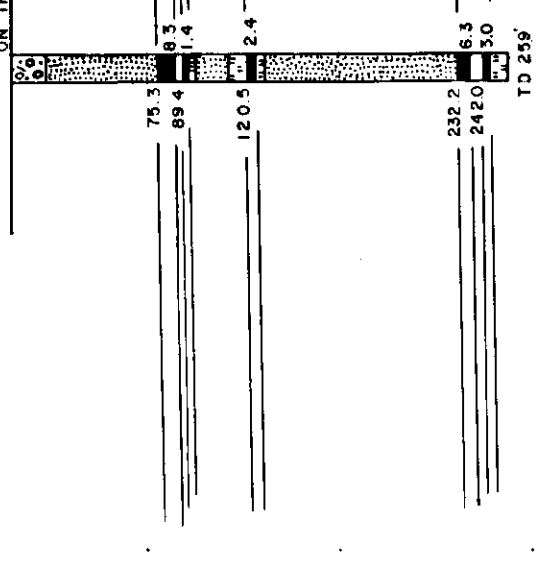

PIT 7 29

LUSCAR LTD.

QUINSAM

LINE NO. 75+00

71
710

DATE: MARCH 7, 1978
DRAWN BY: D. PHIBBS

ex- QUINSAM 78 (2) A

HORIZONTAL 1"=100'
VERTICAL 1"=100'

QSG311/PH23

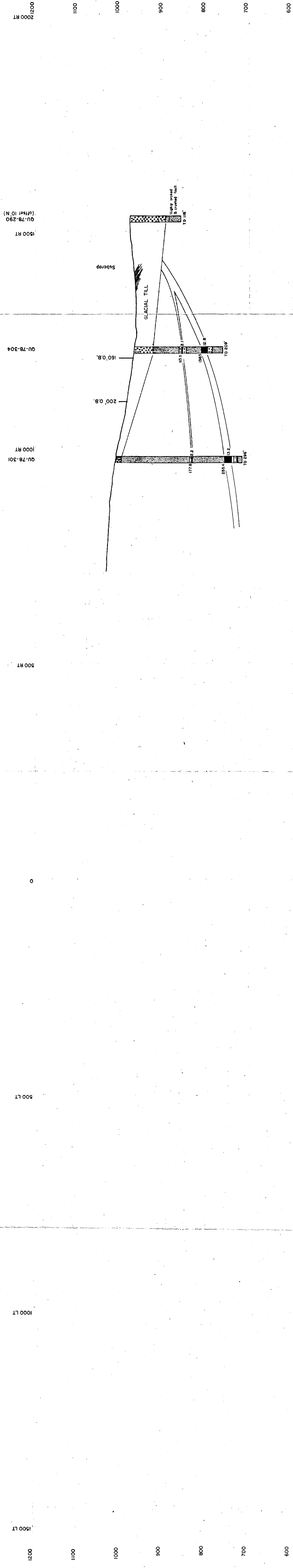

PIT 7 21

13+36

HORIZONTAL: 1"=100'
VERTICAL: 1"=100'

DATE: Feb 16, 1978
DRAWN BY: D. P. H. / W

ex Gunson 78(2)A

QSG 300/PH23

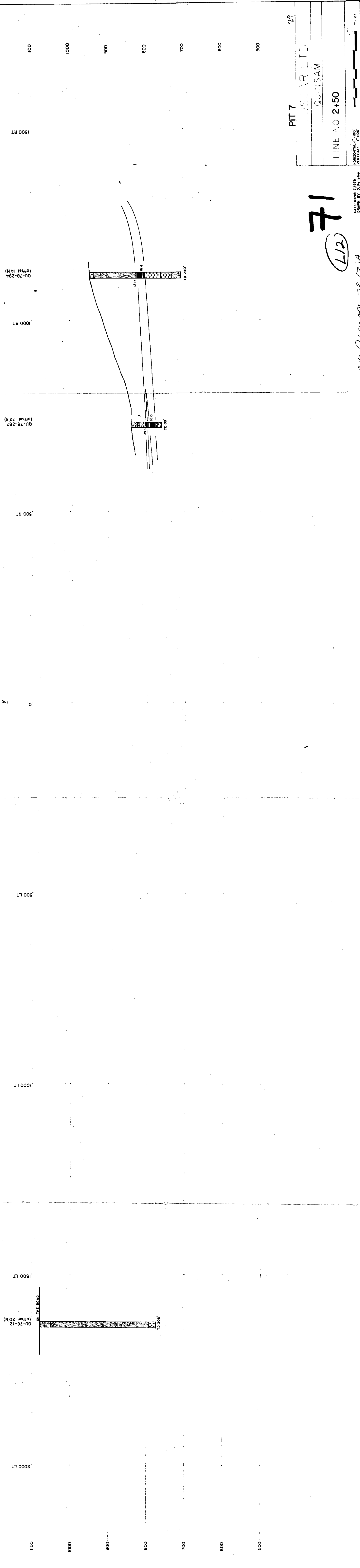

PIT 7 29
 LUSTAR LTD.
 GUNSAM
 LINE NO 2+50

DATE MARCH 7, 1978
 DRAWN BY B. PERINAK

ex GUNSAM 78 (2)A

(L12)

71

HORIZONTAL SCALE 1"=100'
 VERTICAL SCALE 1"=100'
 QSG 298/PH 23

5000 LT
 QU-77-24
 1200
 1100
 1000
 900
 800
 700
 600
 500 RT
 QU-78-295
 (offset 12 N)
 1000 RT
 QU-78-296
 1500 RT
 QU-78-292
 (red III)
 200' OB
 160' OB
 Subcrop
 2500 RT
 QU-78-291
 2000 RT
 QU-78-291
 3000 RT
 QU-78-298

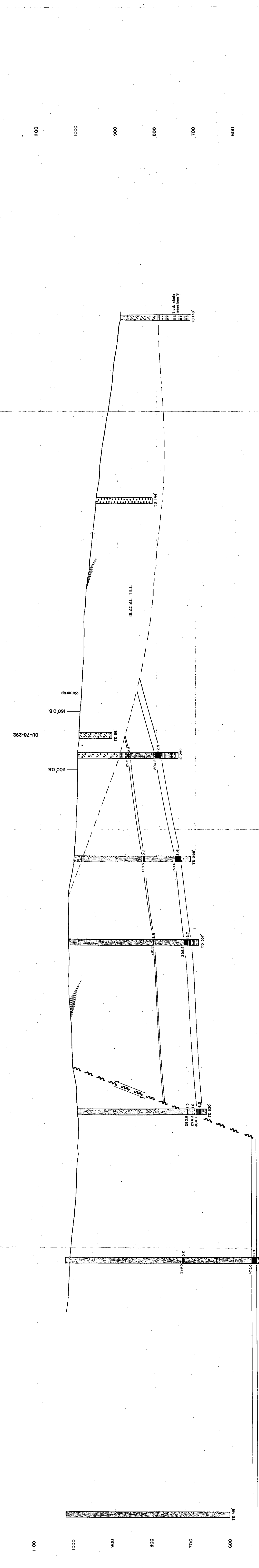

PIT 7
 QUINSAM
 LINE NO 19+00
 QSG 301/PH23

71
 L13

DATE: Feb. 19, 1979
 DRAWN BY: D. Pelletier

ex. Quinsam # (2) 1A

1200 1000LT 500LT 500RT 1000RT 1500RT 2000RT 2500RT

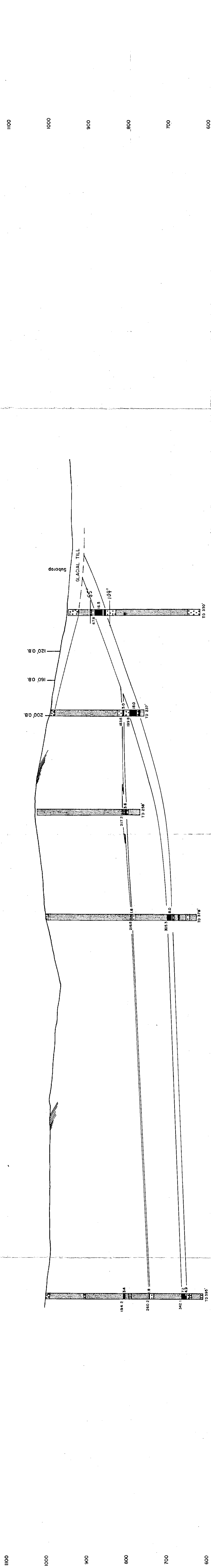

PIT 7 29

71
214

9+00

HORIZONTAL: 1"=100'
VERTICAL: 1"=100'

DATE: Feb 20, 1979
DRAWN BY: D. Peltier

EX- GUNSON 78(2)A

QSG 299/PH 23

1200
1100
1000
900
800
700
600

5000 LT
4500 LT
4000 LT
3500 LT
3000 LT
2500 LT

1200
1100
1000
900
800
700
600

5000 LT
4500 LT
4000 LT
3500 LT
3000 LT
2500 LT

1200
1100
1000
900
800
700
600

5000 LT
4500 LT
4000 LT
3500 LT
3000 LT
2500 LT

1200
1100
1000
900
800
700
600

5000 LT
4500 LT
4000 LT
3500 LT
3000 LT
2500 LT

1200
1100
1000
900
800
700
600

5000 LT
4500 LT
4000 LT
3500 LT
3000 LT
2500 LT

1200
1100
1000
900
800
700
600

5000 LT
4500 LT
4000 LT
3500 LT
3000 LT
2500 LT

1200
1100
1000
900
800
700
600

5000 LT
4500 LT
4000 LT
3500 LT
3000 LT
2500 LT

PIT 4 S

LUSCAR LTD.

QUINSAM

LINE NO. -12+50

HORIZONTAL 1"=100'
VERTICAL 1"=100'

DATE: Feb 20 1979
DRAWN BY: P. H. HARR

71
LI

ex. Quinsam & Co. A.

300
100
0

feet

feet

feet

feet

feet

feet

feet

feet

feet

feet

feet

feet

feet

feet

feet

feet

feet

feet

feet

feet

feet

feet

feet

feet

feet

feet

feet

feet

feet

feet

feet

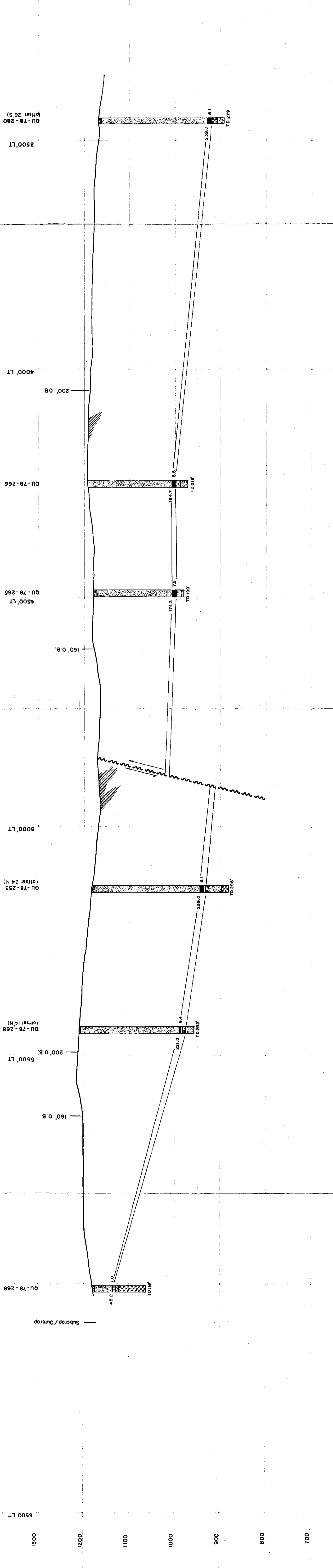

PIT 4S

LUSCAR LTD.

QUINSAM

LINE NO. - 2 + 50

DATE: Nov. 23, 1978
 DRAWN BY: R. Vining

HORIZONTAL: 1"=100'
 VERTICAL: 1"=100'

0 100 200
 miles

71
 L2

ex-Quinsam #131A
 QSG 274/PH23

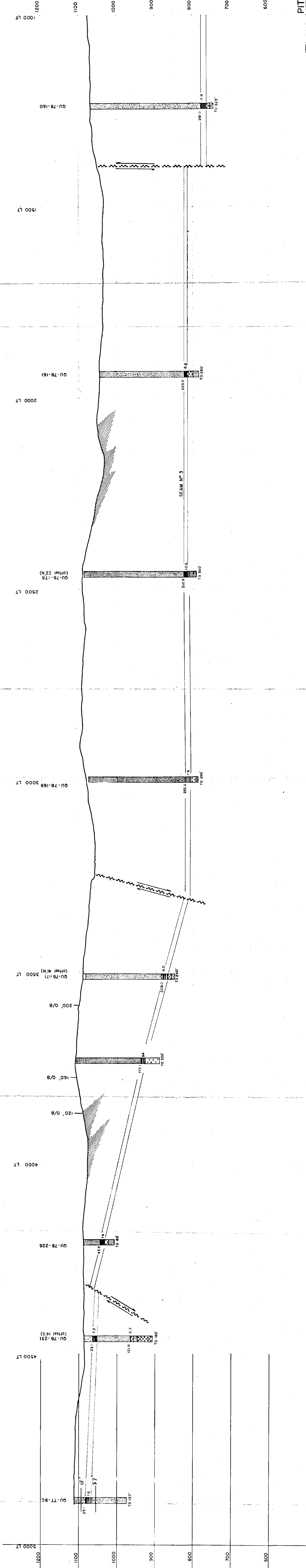

PIT 4S
 LUSCAR LTD
 QUINSAM
 LINE NO 35+00
 DATE: Sep. 22, 1978
 DRAWN BY: R. Valencia
 QSG 283/PH 23

71
 L3

EX-Guinson 71 (2) A

5000 LT 1200 1100 1000 900 800 700 600

1500 LT 2000 LT 2500 LT 3000 LT 3500 LT 4000 LT 4500 LT

QU-78-174 (offset 18.5)

QU-78-227 (offset 32.5)

QU-78-178 (offset 25)

QU-77-6c 4000 LT

QU-78-173 3500 LT

QU-77-13 3000 LT

2500 LT

2000 LT

1500 LT

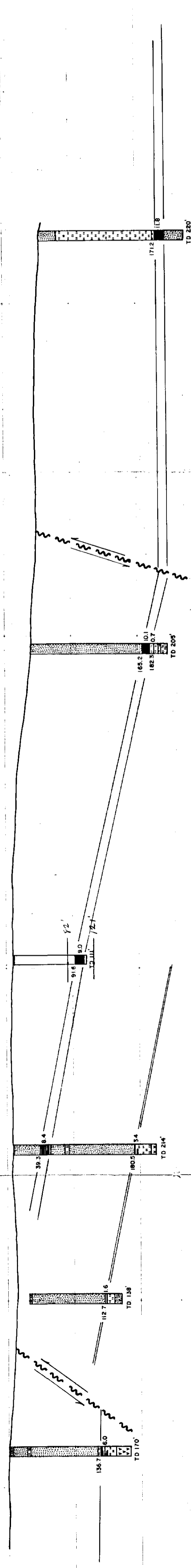

PIT 4S
LUSCAR LTD.
QUINSAM
LINE NO. 40+00

71
L4

DATE March 2, 1978
DRAWN BY D. PHILLIPS

ex- Quinsam 78 (2) A

SCALE
HORIZONTAL: 1"=100'
VERTICAL: 1"=100'

0 50 100 200
miles

QSG 285/PH 23

3500 LT 1400
 4000 LT 1300
 4500 LT 1200
 5000 LT 1100
 5500 LT 1000
 6000 LT 900
 6500 LT 800

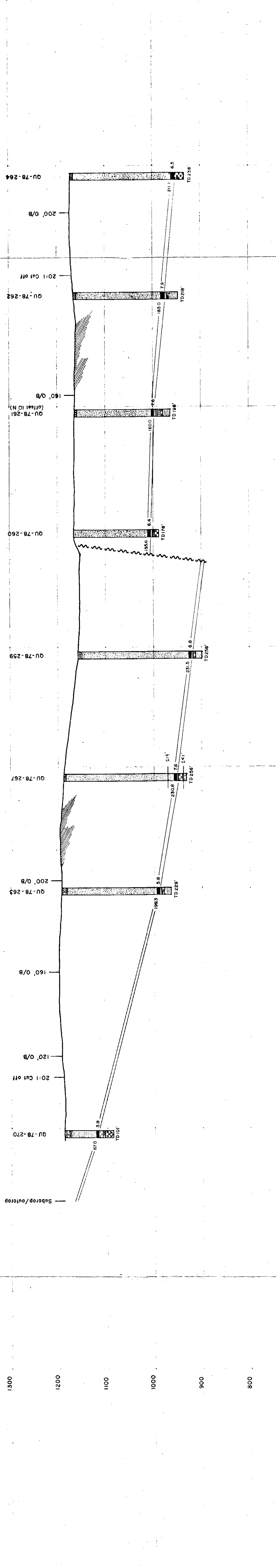

PIT 4 S
 LUSCAR LTD
 QUINSAM
 LINE NO. 2+50
 DATE: October 5, 1978
 DRAWN BY: R. Valencia
 SCALE:
 HORIZONTAL: 1"=100'
 VERTICAL: 1"=100'
 0 100 200
 miles
LS-71
 ex. Quinsam # (2) A
 QSG 275/PH23

PIT 4S

LUSCAR LTD

QUINSAM

LINE NO 37+50

HORIZONTAL: 1"=100'
VERTICAL: 1"=100'

QSG 284/PH 23

DATE: Sep. 18, 1978
DRAWN BY: R. Valencia

EX-Quinsam - 28 (2) A

71
76

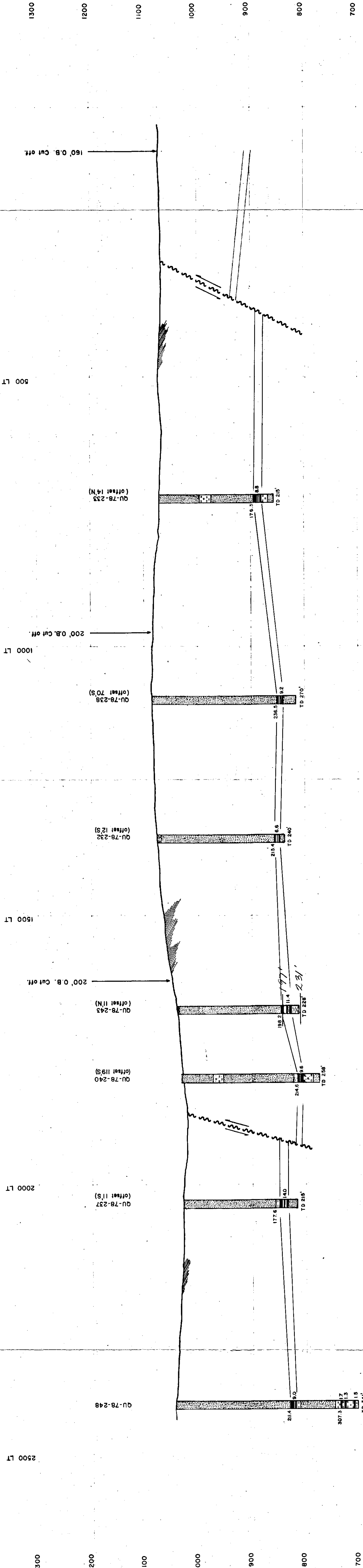

1300
1200
1100
1000
900
800
700

500 LT
1000 LT
1500 LT
2000 LT
2500 LT

160' O.B. Cut off
200' O.B. Cut off
200' O.B. Cut off

QU-78-248 (offset 14' N)
QU-78-238 (offset 70' S)
QU-78-232 (offset 12' S)
QU-78-243 (offset 11' N)
QU-78-240 (offset 119' S)
QU-78-237 (offset 11' S)

TD 215
TD 270
TD 240
TD 228
TD 258
TD 215

9.0
14.0
24.4
19.4
6.5
23.6
17.6

214
215
258
228
215

307.3
17
13
15
TD 341'

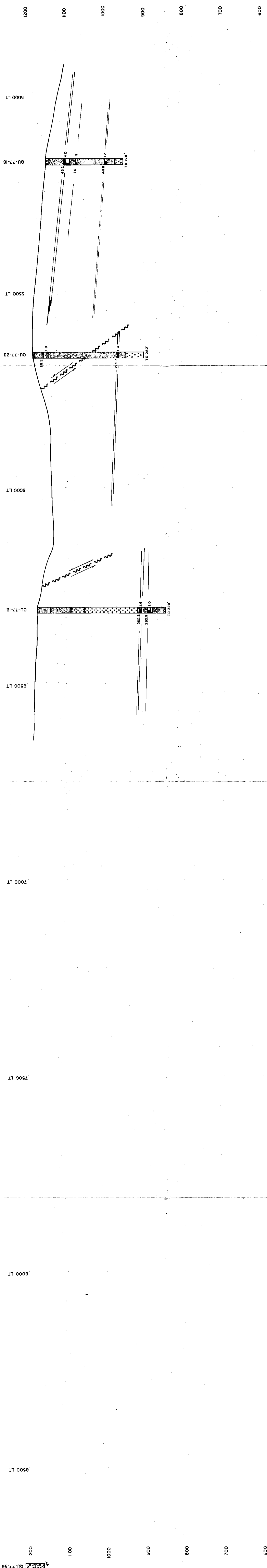

PIT 4S

71
 (L7)

LINE NO 30+00

HORIZONTAL 1"=100'
 VERTICAL 1"=100'

DATE: March 8, 1979
 DRAWN BY: D. Pelletier

Ex: GUNSON - 78 (2) A

QSG 281/PH 23

1400'
1300'
1200'
1100'
1000'
900'
800'

6500 LT
6000 LT
5500 LT
5000 LT
4500 LT
4000 LT

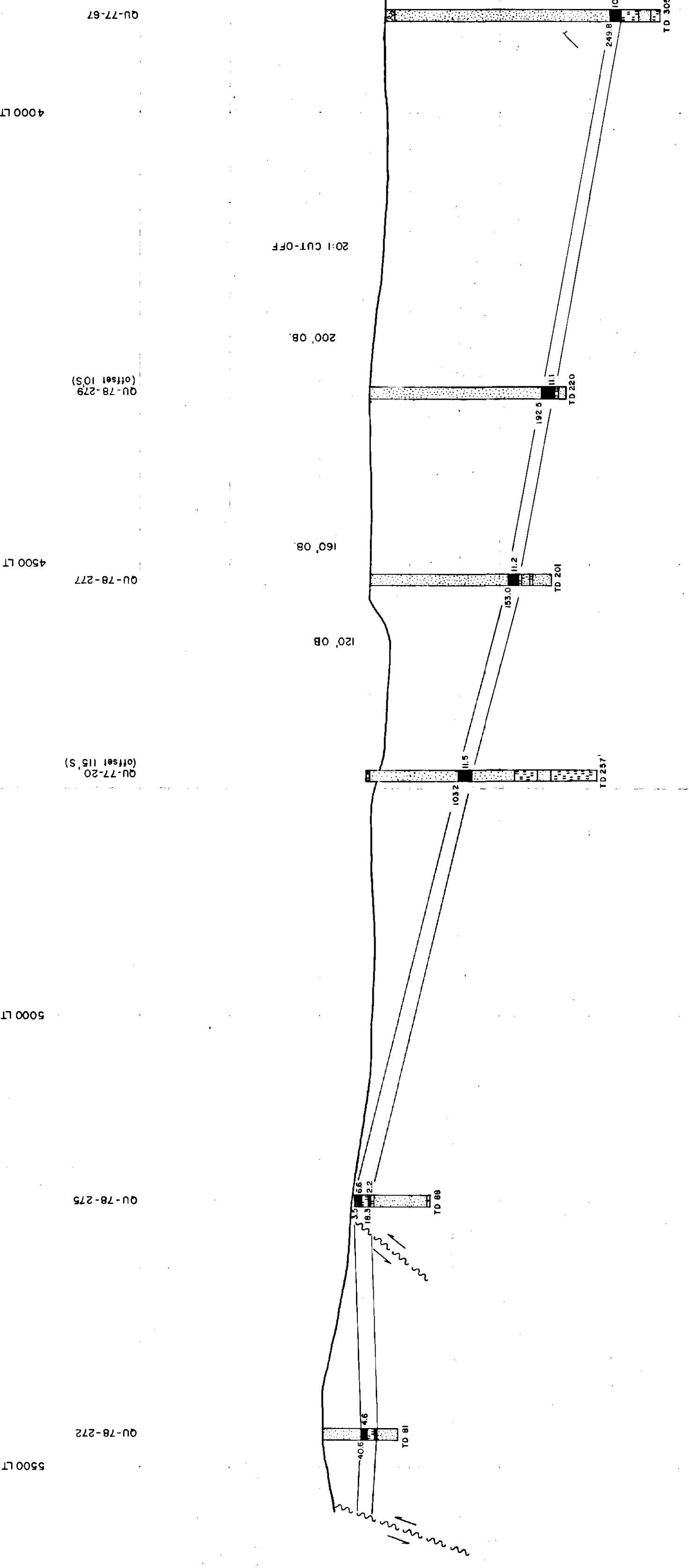

PIT 4S
LUSCAR LTD.
QUINSAM
LINE NO. 21 + 50

1871

DATE: Sept 27 / 78
DRAWN BY: S. L. Sorensen

ex-Quinsam - (2) A

HORIZONTAL = 1" = 100'
VERTICAL = 1" = 100'
250'
miles
QSG 279/PH23

DATE: October 4, 1978
DRAWN BY: R. Valencia

HORIZONTAL SCALE: 1" = 100'
VERTICAL SCALE: 1" = 100'



ex. Quinsam 28/21A

QSG 280/PH23

71
19

PIT 4S
LUSCAR LTD.
QUINSAM
LINE NO. 25+00

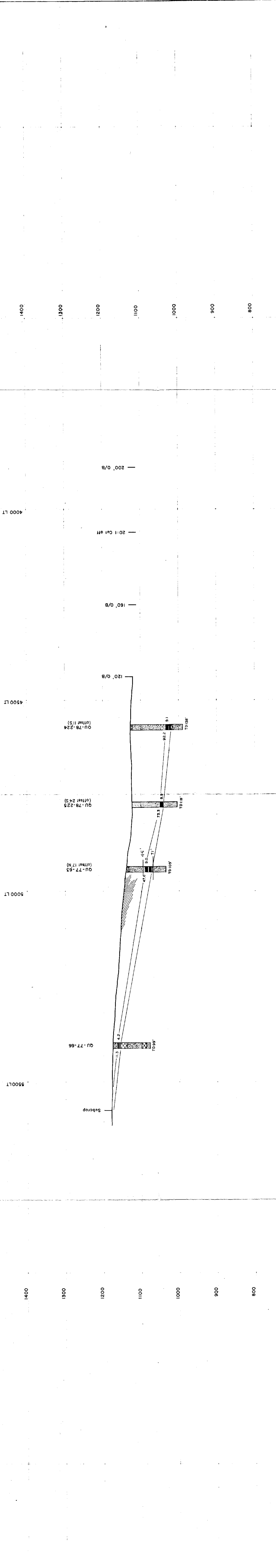

DATE: October 4, 1978
 DRAWN BY: R. Valencia

ex. Quinsam 7821A

QUINSAM

LUSCAR LTD.

PIT 4S

LINE NO. 12+50

71

QS6277/PH23

HORIZONTAL 1"=100'
 VERTICAL 1"=100'

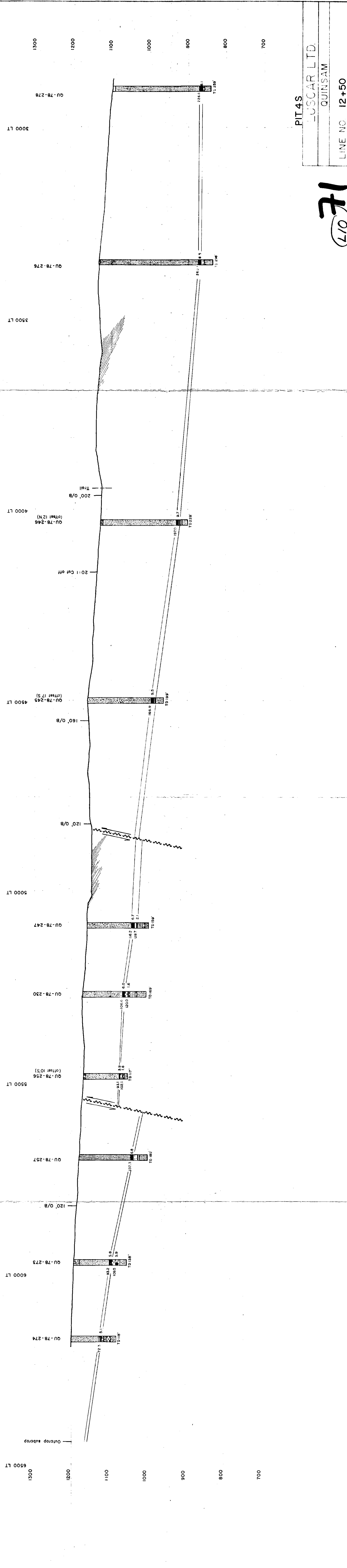

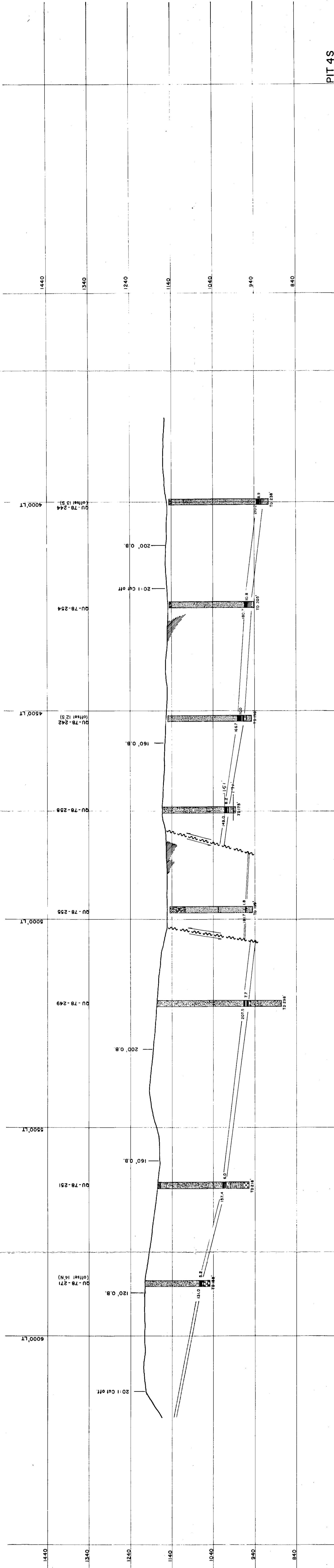

PIT 4S
 LUSCAR LTD.
 QUINSAM
 LINE NO. 7+50

71

DATE: November 23, 1978
 DRAWN BY: R. VOIGT

SCALE
 HORIZONTAL: 1" = 100'
 VERTICAL: 1" = 100'

0 100 200
 feet

QSG276/PH23

C. Quinsam

DATE: Sept 27, 78
DRAWN BY: S.L.T. Soanen

EX- GUNSON 28 (2)A

LINE NO 17 +50

71
L/3

PIT 4S 30

OSMUND
2000 AM

HORIZONTAL: 1" = 100'
VERTICAL: 1" = 100'

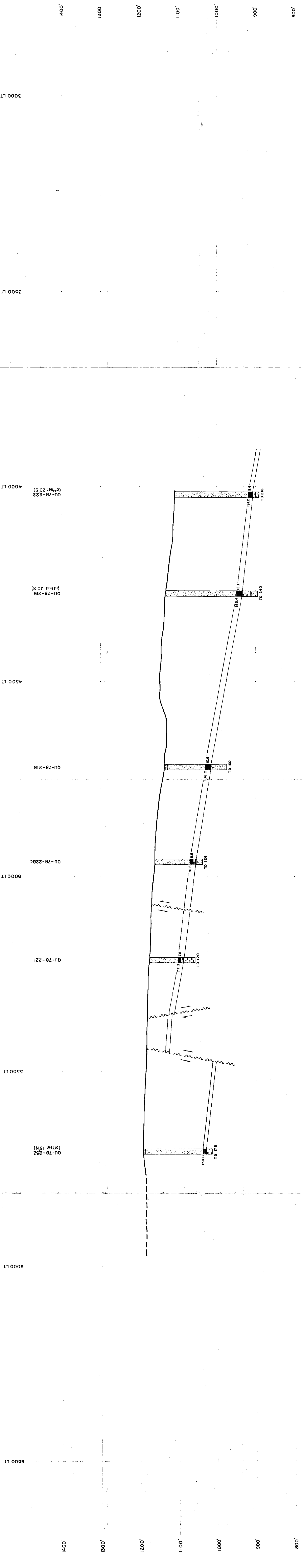

1400'
1300'
1200'
1100'
1000'
900'
800'

3000 LT
3500 LT
4000 LT
4500 LT
5000 LT
5500 LT
6000 LT
6500 LT

