

CONFIDENTIAL

QUINETTE COAL LIMITED

SHIKANO GEOLOGICAL REPORT

TEXT

May 1985

CONFIDENTIAL

GEOLOGICAL BRANCH
ASSESSMENT REPORT

00 619

Supplements 3.2, 3.3 and 3.5, Appendix 1 - Sections 1.5 and 1.9, and Appendix 2 of this report contain coal quality data, and remain confidential under the terms of the *Coal Act Regulation*, Section 2(1). They have been removed from the public version.

http://www.bclaws.ca/EPLibraries/bclaws_new/document/ID/freeside/10_251_2004

PREFACE

This volume and related appendices presents all geological and coal quality data obtained from Shikano exploration programmes to-date. The assessment of this data leads to the calculation of the overall mineable reserves, stripping ratios, and subsequent geotechnical parameters related to mine planning. The extent of geological data obtained to-date provides the required confidence for a decision to proceed with mining of this deposit. Additional exploration drilling is planned during 1985 in the recently confirmed syncline along the western perimeter of the reserve area. Further development drilling and quality control are anticipated as mining progresses, in support of both short range planning and mine operations. Revisions to the previous mine plan and subsequent schedule are presently being undertaken to fully incorporate the current geological interpretation. Based on an assessment of the interpretation, no major changes in the schedule of coal release or approach to mine method and planning are anticipated.

SHIKANO GEOLOGICAL REPORT

TABLE OF CONTENTS

Preface

1.0 SUMMARY AND INTRODUCTION

- 1.1 Summary
- 1.2 Introduction
- 1.3 Location and Access
- 1.4 Property Description
- 1.5 Explorataion Programme Summary
 - 1.5.1 Exploration Programmes Prior to 1985
 - 1.5.2 1985 Exploration Programme
 - 1.5.3 Project Management and Primary Contractors
 - 1.5.4 Standards and Procedures
 - 1.5.4.1 Geophysical Logging
 - 1.5.4.2 Rotary Drilling → ADDITIONAL INFO IS R.D.M.
 - 1.5.4.3 Diamond Drilling
 - 1.5.4.4 Drill Core Analysis
 - 1.5.4.5 Adit Sample Analysis

2.0 GEOLOGY

- 2.1 Regional Stratigraphy
- 2.2 Shikano Stratigraphy
 - 2.2.1 Boulder Creek Formation
 - 2.2.2 Hulcross Formation
 - 2.2.3 Gates Formation
 - 2.2.4 Coal Seam Development and Correlation
- 2.3 Regional Structure
- 2.4 Shikano Structure

3.0 QUALITY

- 3.1 Introduction and Summary
- 3.2 Shikano Raw Coal Quality
- 3.3 Shikano Clean Coal Analyses
 - 3.3.1 Proximate and Ultimate Analyses
 - 3.3.2 Thermal Rheology
 - 3.3.3 Ash Analysis, Ash Fusion and Calorific Value
 - 3.3.4 Petrographic Analysis
 - 3.3.5 Grade
- 3.4 Shikano Bulk Sample Evaluation and Carbonization
 - 3.4.1 Bulk Sample Chemistry and Rank
 - 3.4.2 Thermal Rheology
 - 3.4.3 Carbonization Results
- 3.5 Shikano Yield Estimation

- SHIKANO GEOLOGICAL REPORT
TABLE OF CONTENTS
Page 2

4.0 RESERVES

- 4.1 Summary of Reserves
- 4.2 Reserve Calculation Methods
 - 4.2.1 In Place Reserve Calculation
 - 4.2.2 Run of Mine Reserve Calculation
 - 4.2.3 Plant Feed Reserve Calculation
 - 4.2.4 Product Reserve Calculation

5.0 GEOTECHNICAL STUDIES

- 5.1 Introduction
- 5.2 Description of Investigation
- 5.3 Engineering Geology
- 5.4 Hydrogeology
- 5.5 Slope Stability Analyses and Design
 - 5.5.1 Footwall Slopes
 - 5.5.2 Hanging Wall and Endwall Slopes
 - 5.5.3 General Slope Design Guidelines
 - 5.5.4 Southwest Footwall Ramp
- 5.6 Waste Dump Stability Analysis and Design
 - 5.6.1 Foundation Preparation
 - 5.6.2 North and Alternate Dumps
 - 5.6.3 Centre Dump
 - 5.6.4 South Dump
 - 5.6.5 Additional Recommendations

SHIKANO GEOLOGICAL REPORT

LIST OF FIGURES

<u>Description of Figure</u>	<u>Figure Number</u>
Quintette Coal Limited Area Development	1.1
Quintette Coal Licenses	1.2
Shikano Drillhole and Adit Location Map	1.3
Quintette Coal Limited Drillcore Analysis Flow Diagrams	1.4 - 1.7
Birtley Coal and Minerals Testing Plant Balance Flow Sheets	1.8a - 1.8b
Quintette Coal Limited General Stratigraphic Section	2.1
Quintette Coal Limited Simplified Geology	2.2
Middle Gates Formation Regional Stratigraphic Correlation	2.3
Typical Section of D, E1, and E2 Seam	2.4
Typical Section of F Seam	2.5
Typical Section of G Seam	2.6
Typical Section of J1, J2, and K0 Seams	2.7
Typical Section of K0, K1, and K2 Seams	2.8
Quintette Coal Limited Regional Geologic Structure	2.9
Shikano CV vs Ash Relationship	3.1
D Seam Yield vs Ash Relationship	3.2
E Seam Yield vs Ash Relationship	3.3
F Seam Yield vs Ash Relationship	3.4
G Seam Yield vs Ash Relationship	3.5
J Seam Yield vs Ash Relationship	3.6
K Seam Yield vs Ash Relationship	3.7
Shikano Pit Design (May 1985)	4.1
Oxidation Limit	4.2

SHIKANO GEOLOGICAL REPORT
LIST OF FIGURES
Page 2

<u>Description of Figure</u>	<u>Figure Number</u>
Distribution of Structural Domains and Design Sectors in the Ultimate Pit	5.1
Schematic of Typical Footwall Slope Configuration Based on Footwall Slope Design Guidelines	5.2
Slope Geometry Parameters	5.3
Recommended S.W. Footwall Ramp Design	5.4
Waste Dump Plans, Surficial Geology and Subsurface Investigations	5.5

SHIKANO GEOLOGICAL REPORT

LIST OF TABLES

<u>Description of Table</u>	<u>Table Number</u>
Summary of Key Exploration Activity	1.1
Summary of Interseam Strata in the Coal-Bearing Sequence	2.1
Seam Thickness Summary	2.2
Shikano - Number of Samples Used in Quality Evaluation	3.1
Comparison of Rank as Characterized by Vitrinite Mean Maximum Reflectance of Seams in McConkey, Frame, Shikano, and Babcock Pit Areas	3.2
Comparison of Shikano Quality to Contract Product Specifications	3.3
Shikano Raw Coal Quality - Mean Values of Drillcore/Adit Samples	3.4
Summary of In-Place Ash for Shikano Pit	3.5
Shikano Clean Coal Analysis - Mean Values of Drillcore/Adit Samples	3.6
Shikano Clean Coal Thermal Rheology - Mean Values of Drillcore/Adit Samples	3.7
Comparison of Shikano Clean Coal Thermal Rheology to Other Pits	3.8
Clean Coal Ash Analysis (% of Ash)	3.9
Clean Coal - Fusibility of Coal Ash	3.10
Petrographic Characteristics of Drillcore and Bulk Samples	3.11
Deleterious Material in Shikano Coal	3.12
Summary of Canmet Bulk Sample Results of Chemistry/Rheology and Carbonization	3.13
Summary of Canmet Bulk Sample Results of Ash Analysis	3.14
Shikano Bulk Samples - Average J.S.I. Results	3.15
J.S.I Blend Coking Test	3.16
Yield/Ash Prediction Equations - Shikano Pit	3.17

SHIKANO GEOLOGICAL REPORT
LIST OF TABLES
Page 2

<u>Description of Table</u>	<u>Table Number</u>
Shikano Reserve Summary - Shikano Main	4.1a
Shikano Reserve Summary - M-9 Extension	4.1b
Shikano Ash and Yield Summary	4.2
Predicted Metallurgical Dry Plant Feed Yield Equations	4.3
Summary of Recommended Slope Designs	5.1

SHIKANO GEOLOGICAL REPORT

LIST OF SUPPLEMENTS

- Supplement 2.0 Geological Maps and Cross Sections
- Shikano Geology Map
 - Shikano Geological Cross Sections 23600
 - Shikano Geological Cross Sections 23800
 - Shikano Geological Cross Sections 24000
 - Shikano Geological Cross Sections 24200
 - Shikano Longitudinal Cross Section 22500
 - Shikano Cross-Section A-A1
- Supplement 2.2.4 Coal Seam Correlation Charts
- Shikano D Seam Correlation Chart
 - Shikano E Seam Correlation Chart
 - Shikano F Seam Correlation Chart
 - Shikano G Seam Correlation Chart
 - Shikano J Seam Correlation Chart
 - Shikano K Seam Correlation Chart
- Supplement 3.2 Seam Quality Summaries
- Supplement 3.3.2 Thermal Rheology
- Supplement 3.3.4 Coal Petrographic Summary
- Supplement 3.5 Yield Summary

APPENDICES

APPENDIX 1 SHIKANO GEOLOGY MAPS, CHARTS, AND DRAWINGS

- 1.1 Top of D Seam Structure Contour Map
Top of F Seam Structure Contour Map
Top of G Seam Structure Contour Map
Top of J Seam Structure Contour Map
Top of K Seam Structure Contour Map
- 1.2 Shikano Formation Correlation Chart
Shikano Middle Gates Correlation Chart (Sheet 1 & 2)
- 1.3 Shikano Overburden Isopach Map
- 1.4 Mining Section Thickness Isopach - D Seam
Mining Section Thickness Isopach - E2 Seam
Mining Section Thickness Isopach - F Seam
Mining Section Thickness Isopach - G Seam
Mining Section Thickness Isopach - J Seam
Mining Section Thickness Isopach - K1 Seam
- 1.5 Iso-In-Place Ash Map - D Seam
Iso-In-Place Ash Map - E2 Seam
Iso-In-Place Ash Map - F Seam
Iso-In-Place Ash Map - G Seam
Iso-In-Place Ash Map - J Seam
Iso-In-Place Ash Map - K1 Seam
- 1.6 Mine Grid Cross-Sections 23,200 to 24,700 (incl.)
- 1.7 Adit Drawings (5 sheets)
- 1.8 Shikano Drillhole Geophysical Log Correlation of
Coal-Bearing Section (20 sheets)
- 1.9 Coal Seam Data Summaries

APPENDICES

APPENDIX 2 DRILLCORE AND BULK SAMPLE ANALYTICAL DATA

- 2.1 D Seam Analytical Data
- 2.2 E Seam Analytical Data
- 2.3 F Seam Analytical Data
- 2.4 G Seam Analytical Data
- 2.5 J Seam Analytical Data
- 2.6 K Seam Analytical Data
- 2.7 Other Analytical Data
1982 Adit Analyses - Canmet & J.S.I.
Petrography Composite - QSD85006

APPENDIX 3 GEOTECHNICAL AND HYDROGEOLOGICAL ASSESSMENTS FOR THE DESIGN OF OPEN PIT SLOPES AND WASTE DUMPS FOR THE SHIKANO PROJECT (Piteau Associates)

APPENDIX 1

SHIKANO GEOLOGY MAPS, CHARTS, AND DRAWINGS

- 1.1 Top of D Seam Structure Contour Map
Top of F Seam Structure Contour Map
Top of G Seam Structure Contour Map
Top of J Seam Structure Contour Map
Top of K Seam Structure Contour Map
- 1.2 Shikano Formation Correlation Chart
Shikano Middle Gates Correlation Chart (Sheet 1 & 2)
- 1.3 Shikano Overburden Isopach Map
- 1.4 Mining Section Thickness Isopach - D Seam
Mining Section Thickness Isopach - E2 Seam
Mining Section Thickness Isopach - F Seam
Mining Section Thickness Isopach - G Seam
Mining Section Thickness Isopach - J Seam
Mining Section Thickness Isopach - K1 Seam
- 1.5 Iso-In-Place Ash Map - D Seam
Iso-In-Place Ash Map - E2 Seam
Iso-In-Place Ash Map - F Seam
Iso-In-Place Ash Map - G Seam
Iso-In-Place Ash Map - J Seam
Iso-In-Place Ash Map - K1 Seam
- 1.6 Mine Grid Cross-Sections 23,200 to 24,700 (incl.)
- 1.7 Adit Drawings (5 sheets)
- 1.8 Shikano Drillhole Geophysical Log Correlation of
Coal-Bearing Section (20 sheets)
- 1.9 Coal Seam Data Summaries

619

SHIKANO M-9 EXTENSION - DRILLING PROGRAM 85/06/20 to 85/07/02

HOLE NUMBER	TOTAL DEPTH	D	E	F	G	J	K1	K2
QSR85050	151.6	44.4- 48.4	50.4- 55.7	78.7- 83.0	99.0-103.0	126.2-133.2	138.3-139.8	140.8-141.70
QSR85051	78.0					43.12-50.00	53.88-54.76	57.62- 58.32
QSR85052	127.3					51.20-52.00	71.90-73.60	76.20- 77.80
QSR85053	97.6				27.32-28.34	54.36-65.36	68.90-69.88	73.08- 73.83
QSR85054	114.7					48.50-63.50		
QSR85055	90.9					18.00-29.03	34.96-35.93	38.47- 29.22
QSR85056	91.5				17.04-21.73	41.37-49.83	56.66- 57.68	59.95- 60.77
QSR85057	97.5			24.56-29.90	45.50-51.57	75.08-90.38		
QSR85058	109.7				5.62-10.40	28.57-48.21	54.64- 55.54	57.42- 58.04
QSR85059	128.0				39.66-41.12	76.28-97.36	100.73-110.84	113.52-114.07
QSR85060	134.1	19.30-30.62	34.33-44.62	87.89-96.10	119.81-127.96			
QSR85061	60.8					0-29.78	33.65- 33.95	37.64- 38.16
QSR85062	60.5	-----	NO COAL	-----	-----			
QSR85063	73.3	-----	NO COAL	-----	-----			
QSR85066	66.9					3.54-19.87	23.25- 25.55	41.30- 42.10

1482.2m

July 22, 1985

AFdeF/mesw

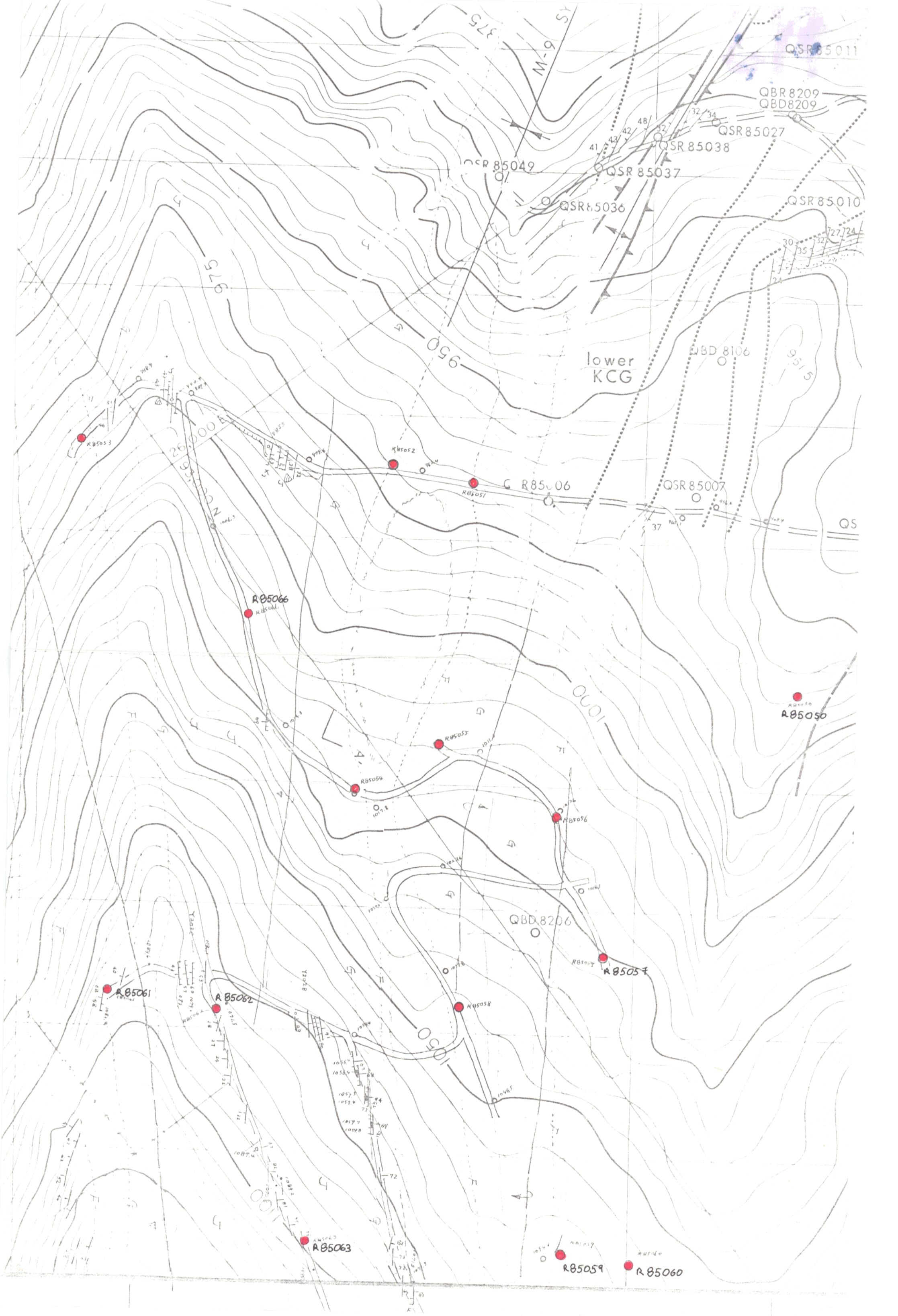

QSR 85011

QBR 8209
QBD 8209

QSR 85027

QSR 85038

QSR 85037

QSR 85036

QSR 85010

QBD 8106

lower
KCG

QSR 85007

QSR 85049

R 85006

QS

R 85066

R 85056

R 85055

R 85054

R 85056

QBD 8206

R 85057

R 85061

R 85062

R 85058

R 85063

R 85059

R 85060

1.0 SUMMARY AND INTRODUCTION

1.1 SUMMARY

1.1.1 Work Completed

A total of 25 diamond drill holes, 82 rotary drill holes, and 6 bulk adit samples have been completed. In addition, there has been detailed surface geological mapping at 1:2500 scale.

1.1.2 Structure

1.1.2.1 Folding

The primary Shikano structure consists of an anticline and syncline fold pair whose axes plunge at approximately 15° to the southeast. Maximum strata dips near 60° are encountered along the folds common limb. Dips of lesser degree, 15 to 40° , predominate throughout the remainder of the structure. A secondary structure consisting of a minor anticline-syncline fold pair extends the three lower mineable seams, G, J and K, approximately 250 meters further west. In contrast to the major structure, the minor folds axes plunge at 10° in the opposite direction - towards the northwest. Associated strata dips range from 10 to 40° . This second structure is referred to as the M-9 anticline-syncline or M-9 extension, while the primary structure is denoted as the Shikano Anticline-Syncline or Shikano Main.

1.1.2.2 Faulting

A total of 3 major faults with maximum vertical displacements greater than 10 meters have been confirmed by drilling within the mine area. Of these faults, the fault associated with the fold pairs common limb attains a displacement of 30 meters. These faults are considered to be fold related because of their proximity to the fold axes.

1.1.3 Coal Seam Development

A total of six continuous coal seams have been correlated throughout the reserve area. They are identified as D, E, F, G, J, and K seams. The average aggregate seam thickness is 17.87 meters. The mining section thickness of individual seams range from a minimum of 0.87 meters in K seam to a maximum of 4.79 meters in J seam.

1.1.4 Coal Quality

The weighted average in place ash content of the mineable coal seams is 26.29%. Addition of an estimated 15 cm of mining dilution increases the ash level to 31.69%, while subsequent planned processing by a Bradford Breaker is expected to reduce the ash content to 28.23%. Average plant feed ash values included in the reserves range from a low of 18.77% in D seam to a high of 41.20% in G seam.

1.1.5 Yield

Based on plant feed ash content, 65.1% of metallurgical plant feed tonnage will be produced at the current contract specification of 9.5% ash content and 8.0% moisture. For producing thermal coal at 10% ash and 8% moisture specifications, an average thermal yield of 57.6% is expected. Metallurgical dry plant feed coal yields range from a low of 46.6% in G seam to a high of 78.9% in D seam. Yield predictions are based on a total of 79 individual washability analyses from both diamond drill core (70) and adit bulk samples (9).

1.1.6 Coke Quality

Pilot scale coke oven tests and related analyses have been performed on seams D, E, F and J by both the Canadian Government (CANMET) and the Japanese Steel Industry (J.S.I.). Tests have been performed on both the individual seams and their various blends with currently produced coking coals. Results indicate that the addition of Shikano coals to the current Quintette plant feed will meet the current level of product coal coke quality.

1.1.7 Reserves

Current product reserves contained within the May 1985 Shikano Pit (Shikano Main) include 6.5 million tonnes (87%) of metallurgical coal and 1.0 million tonnes (13%) of thermal (oxidized coal). These reserves will be produced at a product coal stripping ratio of 7.9 bank cubic meters of waste per tonne of clean coal. Additional clean reserves of 0.9 million tonnes of metallurgical coal and 0.2 million tonnes of thermal coal have been calculated within the M-9 Extension.

1.1.8 Geotechnical

Geotechnical and hydrological studies were carried out for the design of open pit slopes and waste dumps for the Shikano mine area by Piteau and Associates Limited. Their results are summarized in Section 5 of this text and further presented in detail in Appendix 3.

1.2 INTRODUCTION

The Shikano reserve area is named after Mr. T. Shikano, past President of Mitsui Overseas Development Company. It was first referred to as the Syncline Extension area when it was identified as a possible pit area in 1981. Due to its close proximity to the wash plant, the area was included as a positive addition to Quintette Coal Limited's long range mining plans. The earliest reserve assessment was made in the QCL 1-3 mine plan. An estimated total reserve product of 14.6 million tonnes at a stripping ratio of 7.99 bank cubic meters per product tonne was predicted. Subsequent refinements to this original calculation have been made based upon additional exploration data and experience gained from two years of open pit mining in the McConkey and Frame deposits.

1.3 LOCATION AND ACCESS

1.3.1 Location and Access

The Shikano deposit is located to the northeast of Babcock Mountain in the Murray River Valley, 2 km southwest of Quintette Coal Limited's coal preparation plant. The coal bearing Gates Formation is exposed in a syncline-anticline fold pair which outcrop in the wooded lowlands near the Murray River. A west flowing creek (M-11), which transects the deposit, provides drainage for a catchment basin immediately above the deposit along the northeast slope of Babcock Mountain. The elevation of the proposed ultimate pit limit attains 1010 m at the maximum and 785 m at the minimum. The lowest elevation is 20 metres above the 200 year Murray River flood plain. Figure 1.1 illustrates the areas position relative to known surrounding development.

A minor gravel road which intersects the main McConkey - Frame Pit access road provides primary access to the deposit. This crossroad is located about 1 km past the Quintette Coal Limited Administration Office and roughly parallels the east side of the Murray River. Within the deposit, secondary and tertiary exploration roads diverge from the primary access. Presently, there is 6 kilometres of exploration access within the Shikano area.

1.4 PROPERTY DESCRIPTION

The Shikano Pit is included within Coal Lease #6 for the Quintette Property as seen in Figure 1.2. The pit encompasses a total area of approximately 1.5 km².

1.5 EXPLORATION PROGRAMME SUMMARY

A summary of the key exploration activity undertaken on the Shikano reserve area to the end of March 1985 is presented on Table 1.1.

1.5.1 Exploration Programmes Prior to 1985

Exploration and development work has proceeded on the Shikano area since 1981. Much of this work involved limited diamond drilling, rotary drilling, and

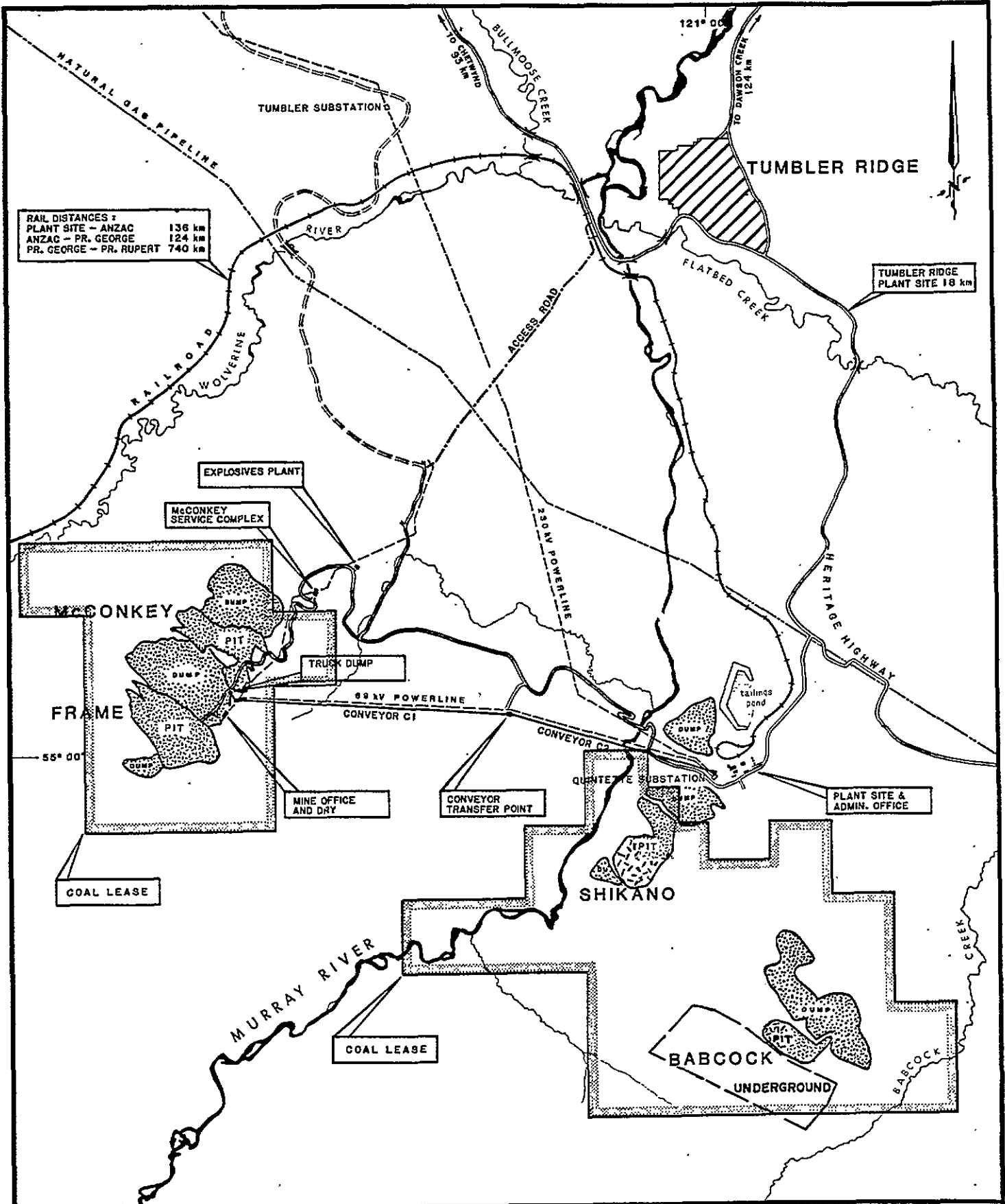

RAIL DISTANCES:
 PLANT SITE - ANZAC 136 km
 ANZAC - PR. GEORGE 124 km
 PR. GEORGE - PR. RUPERT 740 km

TUMBLER RIDGE
 PLANT SITE 18 km

McCONKEY

FRAME

SHIKANO

BABCOCK

QUINTETTE COAL LIMITED

AREA DEVELOPMENT

FIGURE 1.1

AUGUST 1984

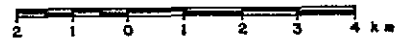

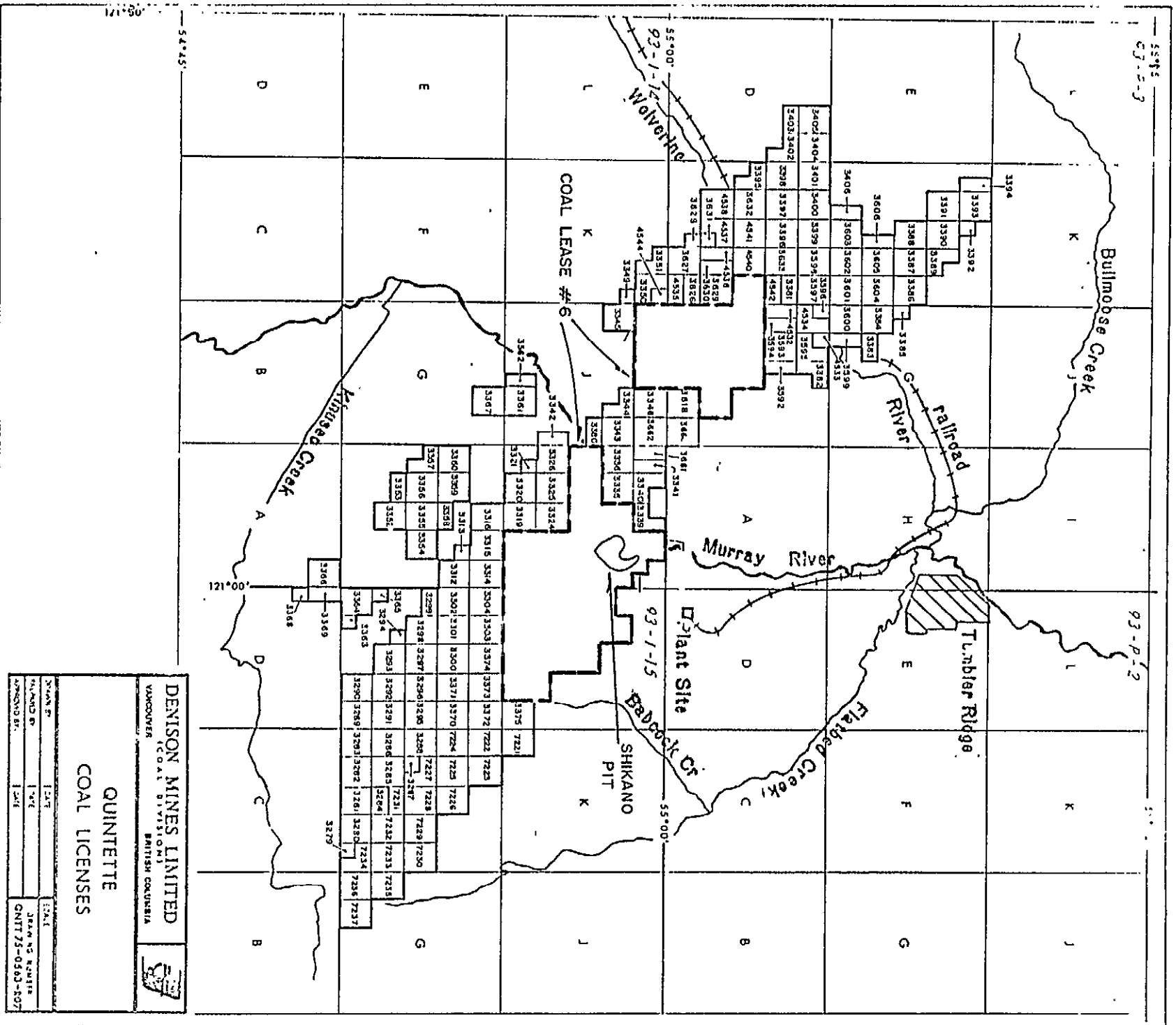

DENISON MINES LIMITED
 COAL DIVISION
 VANCOUVER BRITISH COLUMBIA



**QUINETTE
 COAL LICENSES**

SCALE	1:25,000	DATE	1975
REVISED BY	1:47	DATE	1975
APPROVED BY	1:47	DATE	1975
PROJECT NO.	1:47	DATE	1975

FIGURE 1.2

geologic mapping to determine the presence of economic coal seam thickness and quality suitable for mining. Four adit driveages were also completed to substantiate the continuity and quality of the seams.

1.5.2 1985 Exploration/Development Programme

The 1985 exploration programme consisted of diamond and rotary drill holes located throughout the Shikano pit area. The programme's objective was to confirm the continuity of structure, stratigraphy, and coal seam development such that mining could proceed. The drilling was initiated in January, and, upon completion in April, a total of 53 rotary and 8 diamond holes were drilled. The core from the diamond hole was visually logged and individual coal seams were sampled and sent to Cyclone Engineering Sales Limited for analysis. One new J seam adit (QSA 8501) was completed and sampled in April. The sample was sent to Birtley Coal and Minerals Testing for washability analysis and to CANMET for carbonization tests. The distribution of all drill hole and adit locations is illustrated on Figure 1.3.

1.5.3 Project Management and Primary Contractors

Project Management

All exploration programmes and report compilation was managed by the long range geological and engineering staff of Quintette Coal Limited. Assistance, both in the field and the office, was provided by geological staff of Mitsui Mining Overseas Development Company Limited and Charbonnages de France. Key staff members are listed as follows:

G. P. Gormley - Chief Geologist, Quintette Coal Limited
I. Kakazaki - Chief Geologist, Mitsui Mining Overseas Development Company Ltd.
R. Leeder - Plant Process Development Engineer, Denison Mines Limited
D. Johnson - Geologist, Quintette Coal Limited
K. James - Geologist, Quintette Coal Limited
B. Wong - Geological Engineer, Quintette Coal Limited
B. Delsahut - Geologist, Charbonnages de France
D. McNeil - Geological Technician, Quintette Coal Limited
B. Holmlund - Geological Technician, Quintette Coal Limited
Y. Tainaka - Geological Technician, Quintette Coal Limited
K. Vandenameele - Drafting, Quintette Coal Limited

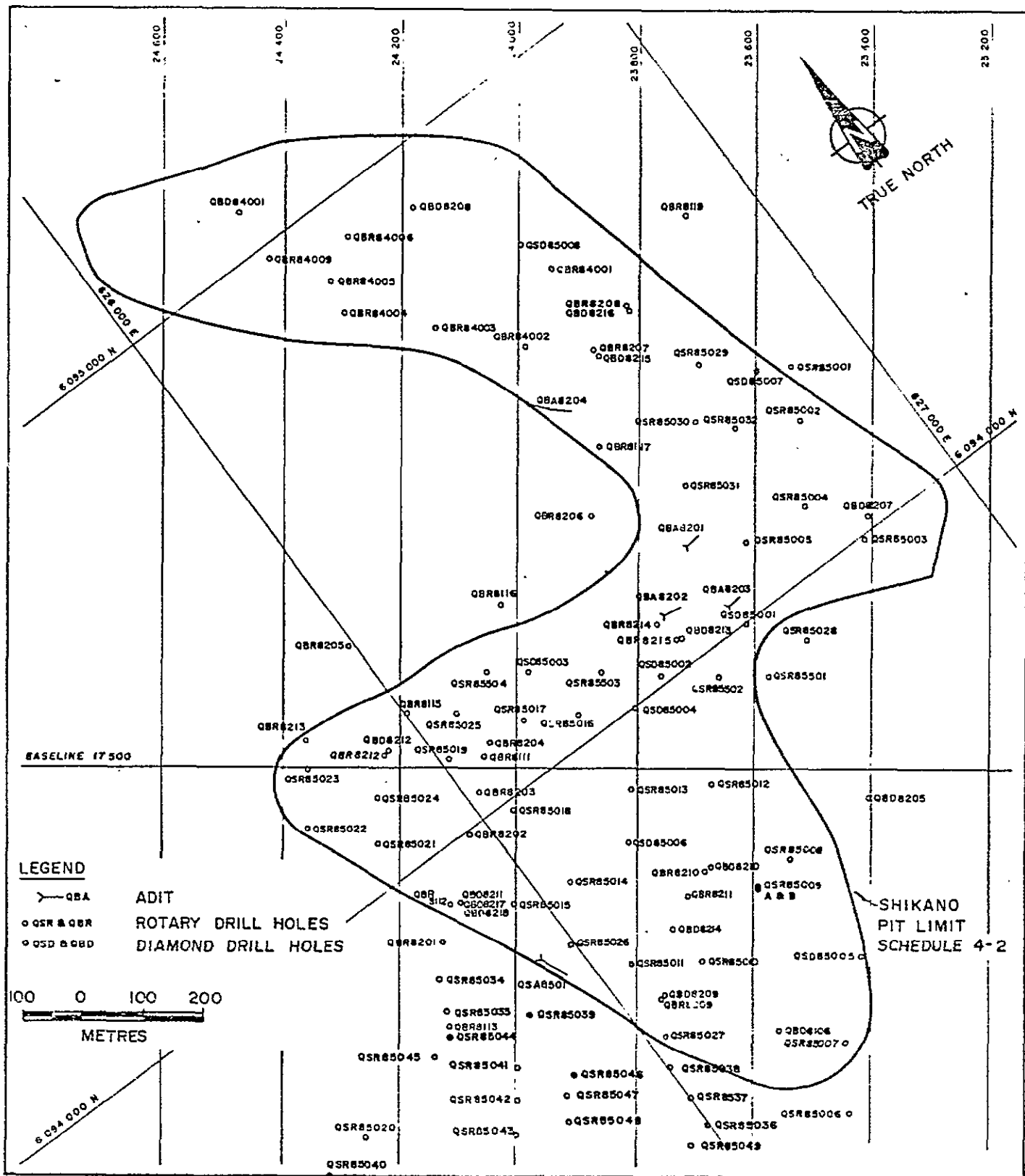

SHIKANO DRILL HOLE AND ADIT LOCATION MAP

APRIL, 1985

FIGURE 1.3

TABLE 1.1
 SUMMARY OF KEY EXPLORATION ACTIVITY
 SHIKANO

<u>Year Completed</u>	<u>Rotary Drilling</u>		<u>Diamond Drilling</u>		<u>Adits</u>		
	<u>No of Holes</u>	<u>Meters</u>	<u>No of Holes</u>	<u>Meters</u>	<u>No of Adits</u>	<u>Seam</u>	<u>Meters</u>
1981	7	963.0	2	1038.00	--	--	--
1982	15	1198.0	14*	1267.00	4	D,E F,J2	216.5
1984	7	660.1	1	153.07	--	--	--
1985	<u>53</u>	<u>6399.1</u>	<u>8</u>	<u>1354.88</u>	<u>1</u>	J	<u>52.0</u>
TOTAL	<u>82</u>	<u>9221.0</u>	<u>25</u>	<u>3812.95</u>	<u>5</u>		<u>268.5</u>

* Diamond drilling includes cored rotary holes.

Primary Contractors

The following lists all contractors involved in the most significant aspects of exploration since commencement of activity in 1981.

<u>Nature of Activity</u>	<u>Contracted Company and Year</u>
Road, adit, and drill site construction	Tompkins Contracting Ltd. 1981
	Lee's Ventures 1982
	Loiselle Construction 1984
	P. Fischer Construction 1985
Diamond Drilling	Canadian Longyear 1981, 1982, 1984 and 1985
	Northern Wireline 1982
Rotary Drilling	Garrity & Baker Drilling Ltd. 1981
	Northern Wireline 1982
	Specialized Drilling Systems 1982, 1984, 1985
	Western Hydro Air 1985
Surveying	Watson and Associates 1981, 1982
	McElhanney and Associates 1984*, 1985*
Geophysical Logging	B.P.B. 1981
	Roke 1982
	Century Geophysical Corp. 1984*, 1985*

* Denotes Activity Supplemented by Quintette Coal Limited Staff and Equipment

<u>Nature of Activity</u>	<u>Contracted Company and Year</u>
Drill Core Analysis	General Testing Laboratories 1981, 1982, 1985
	Cyclone Engineering Sales Ltd. 1985
Bulk (Adit) Sample Analysis	Birtley Coal and Minerals Testing 1982, 1985
Cartography	Burnett Resource Surveys Ltd. 1975, 1976
Adit Construction and Sampling	Target Tunnelling Ltd. 1982, 1985
Geotechnical Studies	Golder and Associates 1981, 1982
	Piteau and Associates 1984, 1985

1.5.4 Standards and Procedures

1.5.4.1 Geophysical Logging

All rotary and diamond drill holes have been logged by geophysical equipment since the commencement of drilling in 1981. However, in some instances, the caving of drill holes has either prevented the completion of geophysical logs or required the holes to be logged through the drill stem. The types of geophysical logs completed include the following:

1. Gamma
2. Neutron
3. Density
4. Caliper
5. Deviation
6. Resistivity

All mining section thickness data points used in the reserve calculation from rotary drill holes were taken directly from geophysical logs and corrected for seam dip from local structural interpretation. In the case of diamond drill holes, the geophysical logs were used to confirm missing intervals within the mining sections, and as an overall apparent thickness subsequent to dip corrections made from actual core measurements. Copies of all geophysical logs are available in the administration building of Quintette Coal Limited. Reduced copies of these logs were used to form correlation charts of the coal bearing section which are presented in Appendix 1, Section 1.8.

1.5.4.2 Rotary Drilling

The contract rotary drill companies listed previously have drilled only vertical holes with both down hole hammer and conventional reverse circulation equipment. Through past experience, it has been found that rotary sampling does not provide representative samples of the coal seams because of contamination inherent in the drilling procedure. In

some instances however, where near surface intersections have been made, samples normally taken at one meter intervals have been used to provide an indication of seam oxidation through free swelling index tests.

1.5.4.3 Diamond Drilling

The diamond drilling contractors listed previously have mostly drilled vertical holes of H.Q. core size (64 mm diameter) using conventional wireline recovery equipment. Only drill holes QBD8208 and QBD8105 required angle drilling. Each drill hole was geophysically logged followed by detailed visual core descriptions. Then, all mineable coal sections were sampled. Approximately 5 kilograms of coal sample was taken from each metre of mineable section and sent to off site laboratories for washability and related analyses as described in the following section. During 1982, a limited amount of coring was completed in the coal bearing horizon using rotary drilling equipment. These holes are identified as QBD 8209 to QBD 8218 inclusively.

The detailed written descriptions of all cored drill holes is available in the Quintette Coal Limited Administration office. The graphical presentation of all core holes is provided in correlation charts found in Appendix 1, Section 1.2.

1.5.4.4 Drill Core Analysis

Drill core samples of the mining sections in which 80%, or better, core recovery has been achieved normally provide the primary data points for the assessment of in-place ash content, washability yield predictions, and other physical and chemical tests. Normal procedures involve the segregation of any selected mining section into various sample components associated with in-seam rock partings. These samples are then combined into into a single sample representing the actual section to be mined. Flow diagrams relating the types of laboratory work undertaken on the Shikano drill core are presented on Figures 1.4 to 1.7 inclusively. Detailed test results from drill core sampling are presented in Appendix 2.

QUINTETTE COAL LIMITED

1981 DRILL CORE ANALYSIS FLOW DIAGRAM (+40% Core Recovery)

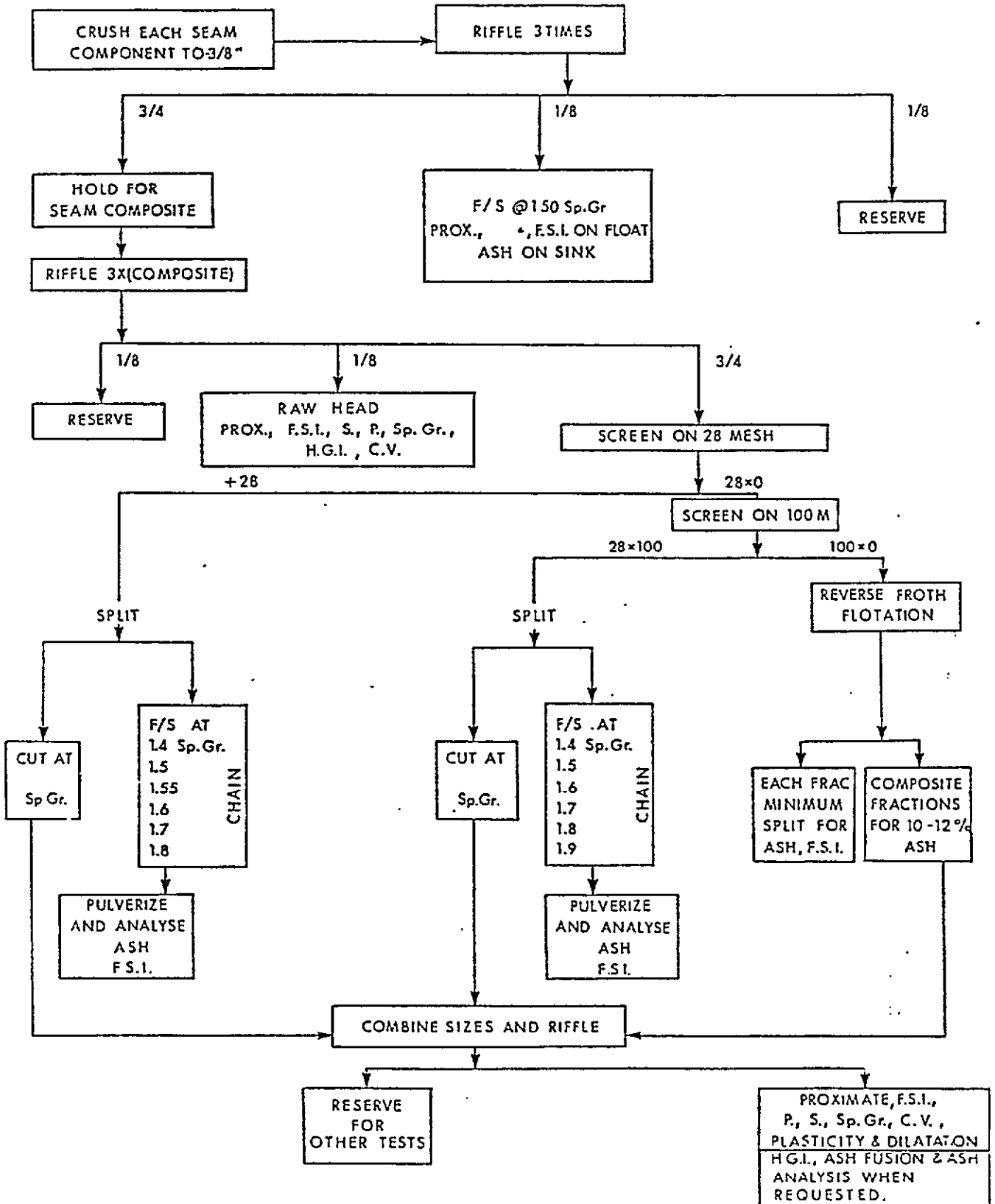

FIGURE 1.4

QUINTETTE COAL LIMITED
1982 DRILL CORE ANALYSIS FLOW DIAGRAM
 (+40% Core Recovery)

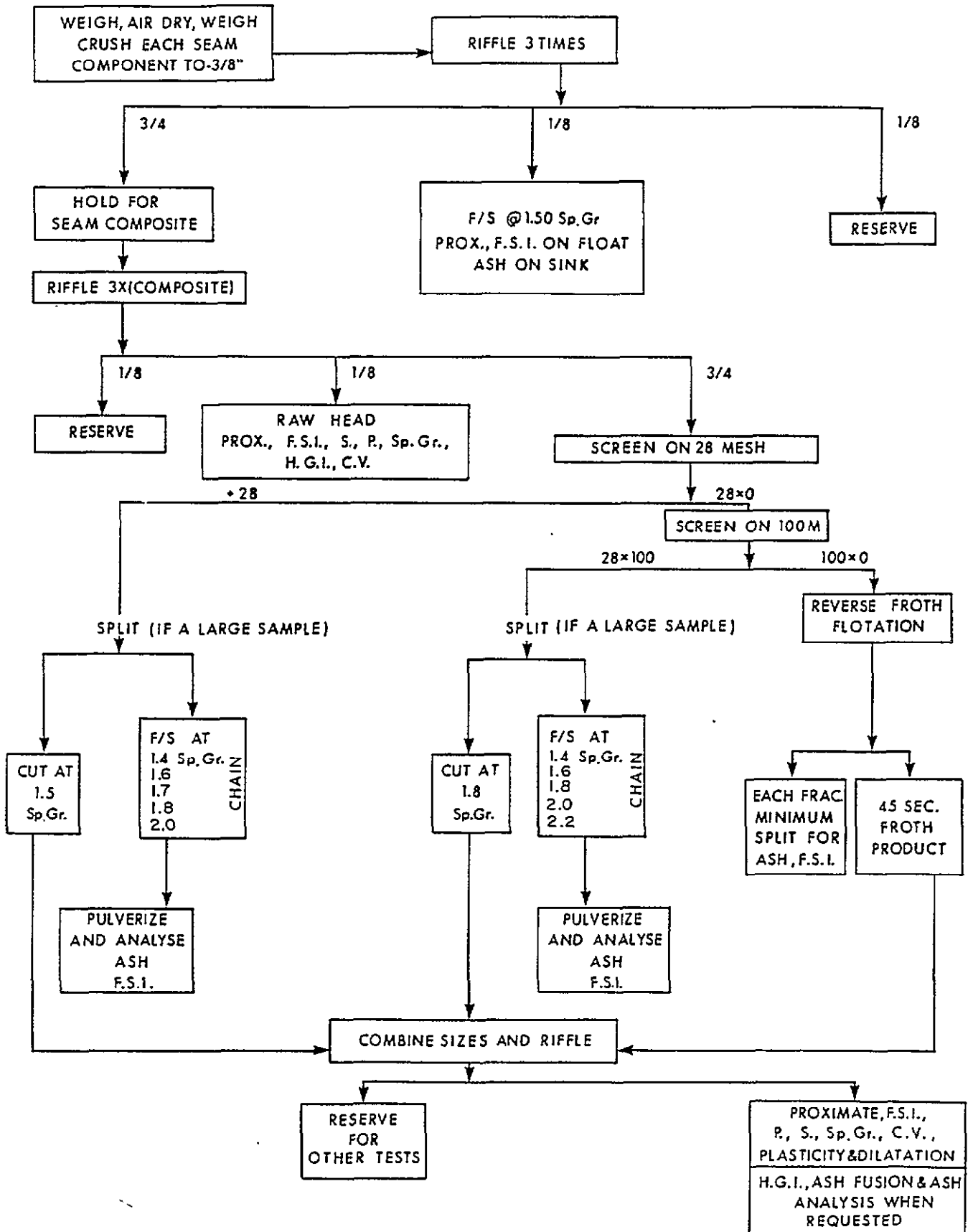

FIGURE 1.5

QUINTETTE COAL LIMITED

1984 DRILL CORE ANALYSIS FLOW DIAGRAM

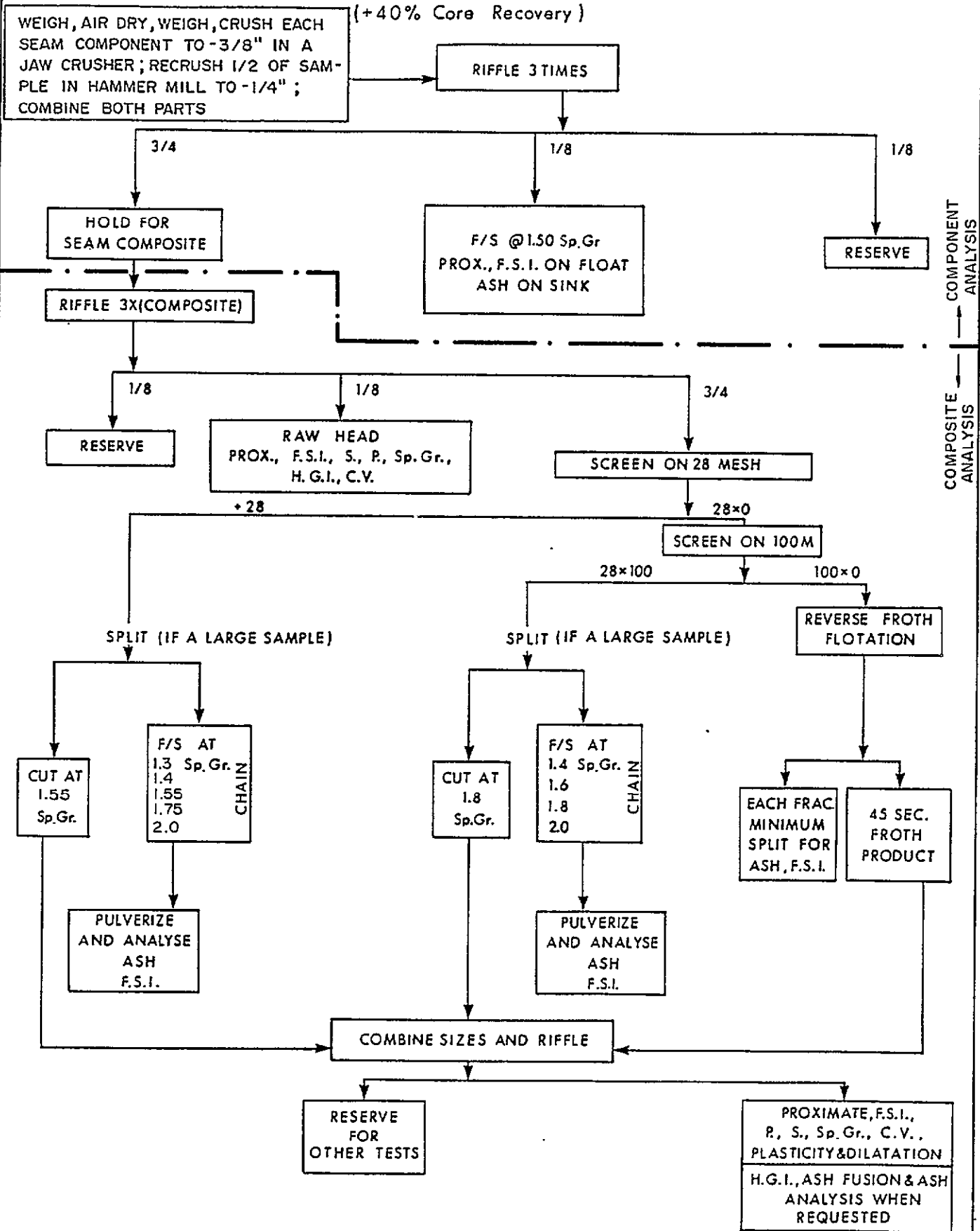

FIGURE 1.6

QUINTETTE COAL LIMITED

1985 DRILL CORE ANALYSIS FLOW DIAGRAM

(+40% Core Recovery)

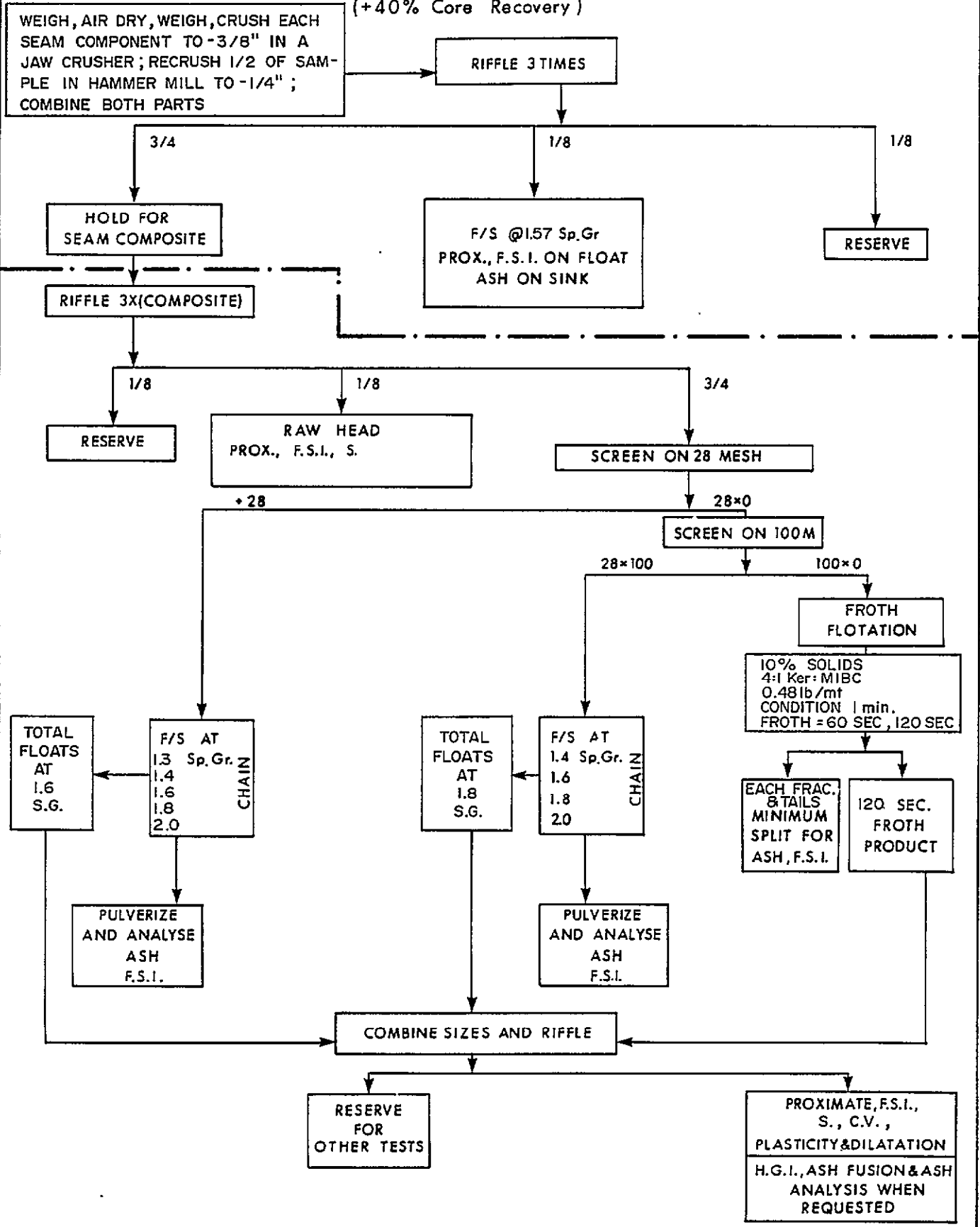
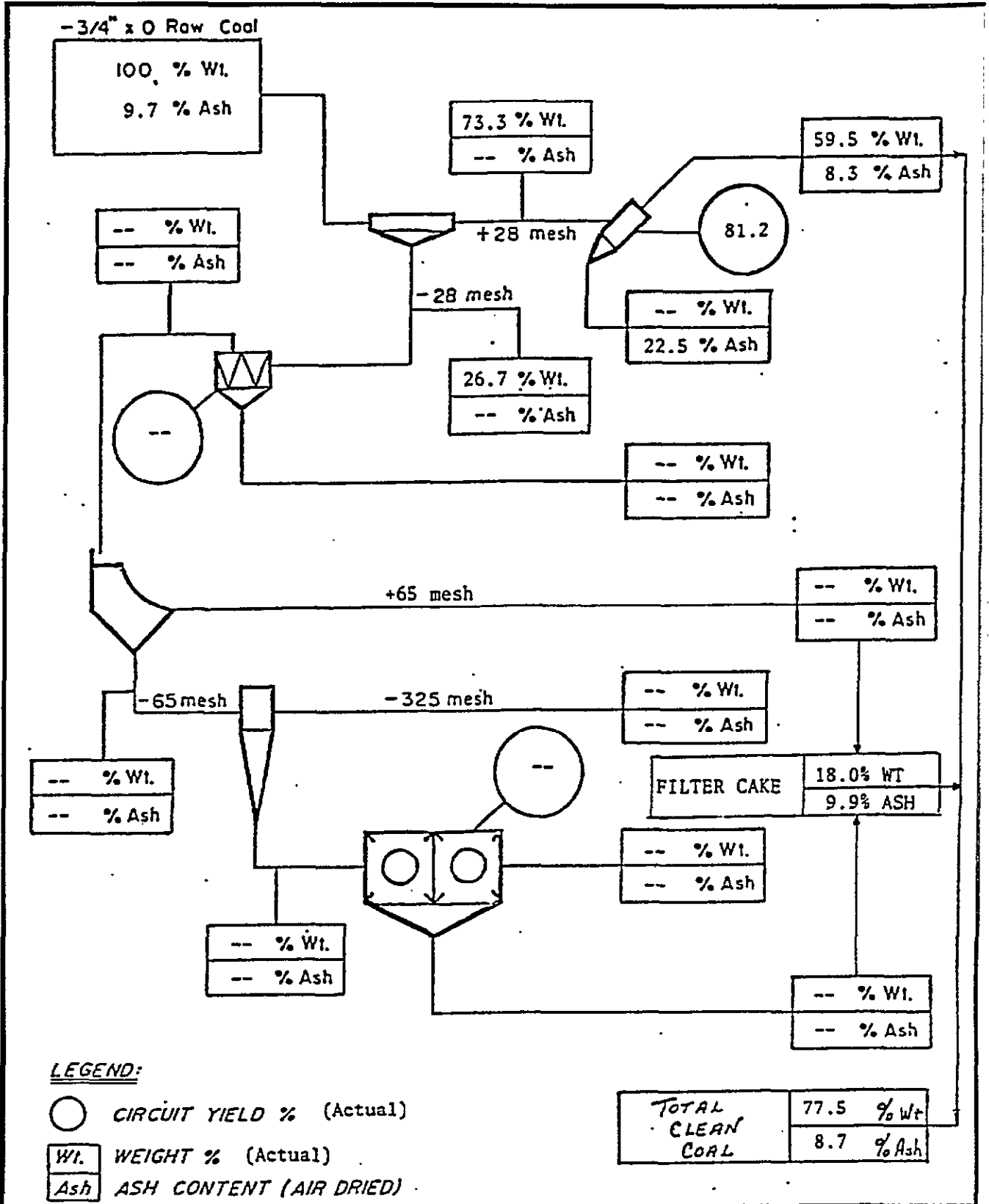

FIGURE 1.7

1.5.4.5 Adit Sample Analysis

Adit or bulk samples were completed to provide additional information on washability and coal size distribution. Moreover, large quantities of coal cleaned through pilot plant washing were carbonized by the Federal Government Laboratory (CANMET) and the Japanese Steel Industry (J.S.I.). Adit locations can be found on the Geological map in Appendix 1. Adit drawings, located in Appendix 1, Section 1.7, provide details of the driveages and the sampled sections. Analytical results for all tests completed on the Shikano adits are presented in Appendix 2. The typical pilot plant flow diagram used in the preparation of clean coal is illustrated in Figures 1.8a and 1.8b.



- 3/4" x 0 Fcw Cool

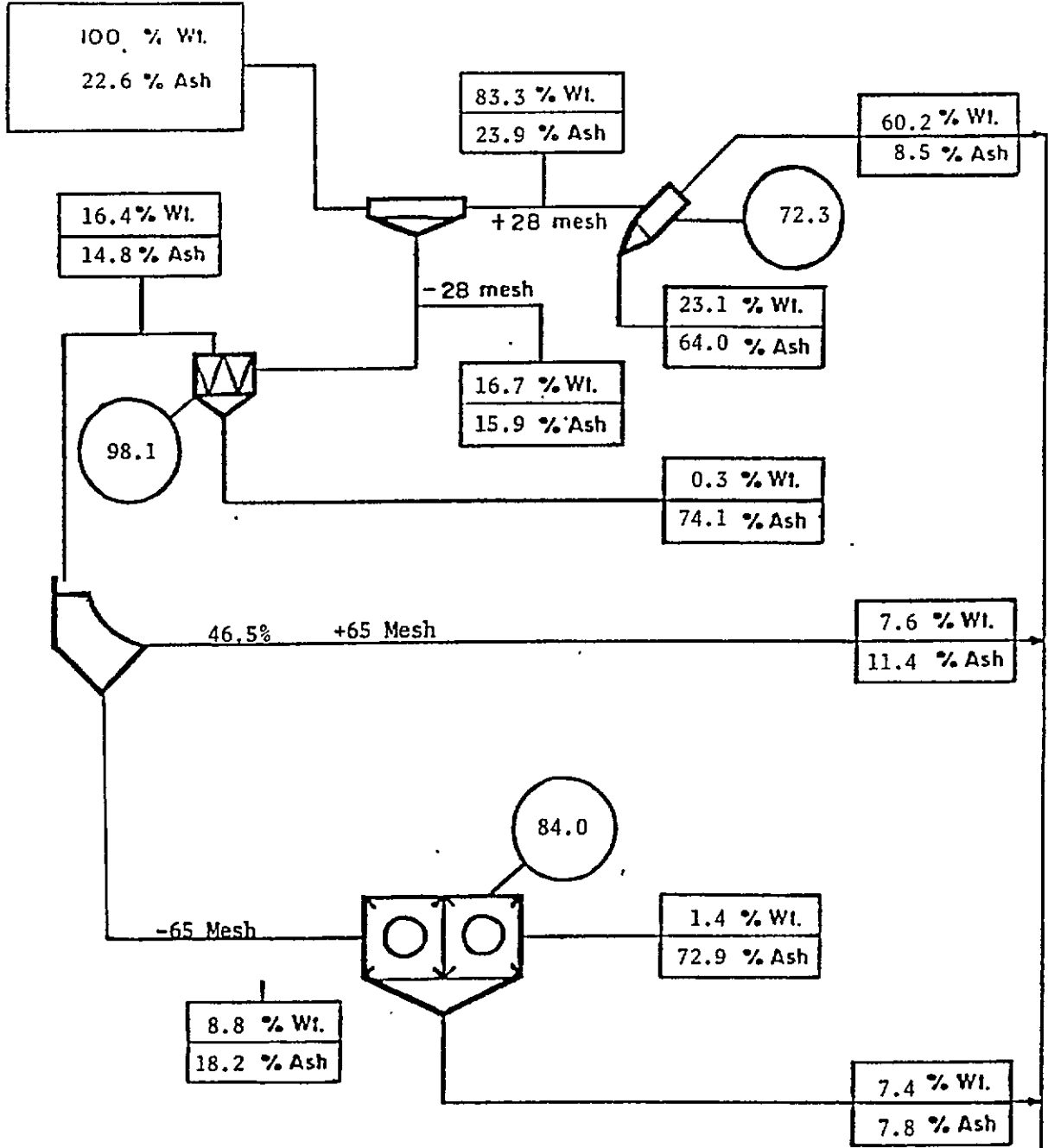

LEGEND:

○ CIRCUIT YIELD %

Wt. WEIGHT %

Ash ASH CONTENT (AIR DRIED)

TOTAL CLEAN COAL	75.2 % Wt.
	8.7 % Ash

BIRLEY BIRTLEY COAL & MINERALS TESTING

Title PLANT BALANCE FLOW SHEET
 QUINTETTE COAL LIMITED
 " SHIKANO J SEAM (1985)" BULK SAMPLE

FIGURE 1.8B

Date
 MAY, 1985

LAB NO: 5684

Drawn

SECTION 2.0

GEOLOGY

2.0 GEOLOGY

2.1 REGIONAL STRATIGRAPHY

The stratigraphic succession exposed on the Quintette property ranges from Upper Jurassic to Lower Cretaceous in age. It consists of inter-tonguing shales and sands of both marine and continental origin. Most of the coal bearing strata is derived from a deltaic environment. The table of formations for the area is outlined in Figure 2.1, with general formation thickness ranges and coal zones as encountered by past exploration. The coal seams of economic thickness and quality are found in the Gates and the Gething Formations. The regional distribution of these formations is illustrated in Figures 2.2 and 2.3.

Further descriptions of the formations encountered at Quintette can be found in the Quintette Geological Reports for 1981, 1982, and 1983.

2.2 SHIKANO STRATIGRAPHY

The stratigraphic sequence exposed on the Shikano area is primarily restricted to the Boulder Creek Formation, the Hulcross Formation, and the economically coal-bearing Gates Formation. The Shikano Geology Map presented in Supplement 2.0 illustrates the distribution of these stratigraphic units and the position of the economic coal seams. The open pit mine currently planned for the Shikano deposit will excavate strata from the upper Hulcross Formation to the base of K seam in the middle sequence of the Gates Formation.

In addition to the bedrock geology, thick surficial deposits (overburden) of gravel, sand and clay have been discovered. To properly evaluate the impact of these deposits, an overburden isopach map has been developed. (see the Overburden Isopach Map, Section 1.3, Appendix 1). As seen on this map, the major overburden thicknesses occur in two areas; the M-11 Creek valley and alongside the Murray River. Overburden in these areas attain thicknesses well over 30 meters.

LOWER CRETACEOUS

FORT ST. JOHN GROUP

SHAFTESBURY
FORMATION
(82+ m)

Interbedded gray shale and mudstone.

BOULDER
CREEK
FORMATION
(122 - 140 m)

Sandstone, conglomerate and shale with
carbonaceous materials.

HULCROSS
FORMATION
(75 - 105m)

Marine shale with sideritic concretions and
mudstones.

GATES FORMATION
(262 - 274 m)

UPPER

A
B
C
Thin coals

Babcock Member

Cyclic alternation of
interbedded gray shale and
coarse to fine grain sand-
stone, conglomerate and coal.

MIDDLE

D
E
F
Coal Zone

LOWER

G/I
J
K

Torrrens Member

MOOSEBAR
FORMATION
(120 - 215 m)

Marine shale with sideritic concretions,
glauconitic sandstone at base.

BULLHEAD GROUP

GETHING
FORMATION
(120 - 200m)

Bird, Skeeter - Chamberlain

Middle Coal Zone

CADOMIN 15-45 m

Basal conglomerate

UPPER JURASSIC

MINNES
GROUP
(~ 2100m)

Siltstones, shales, some sandstone and coaly
shale.

QUINTETTE COAL LIMITED GENERAL STRATIGRAPHIC SECTION

FIGURE 2.1

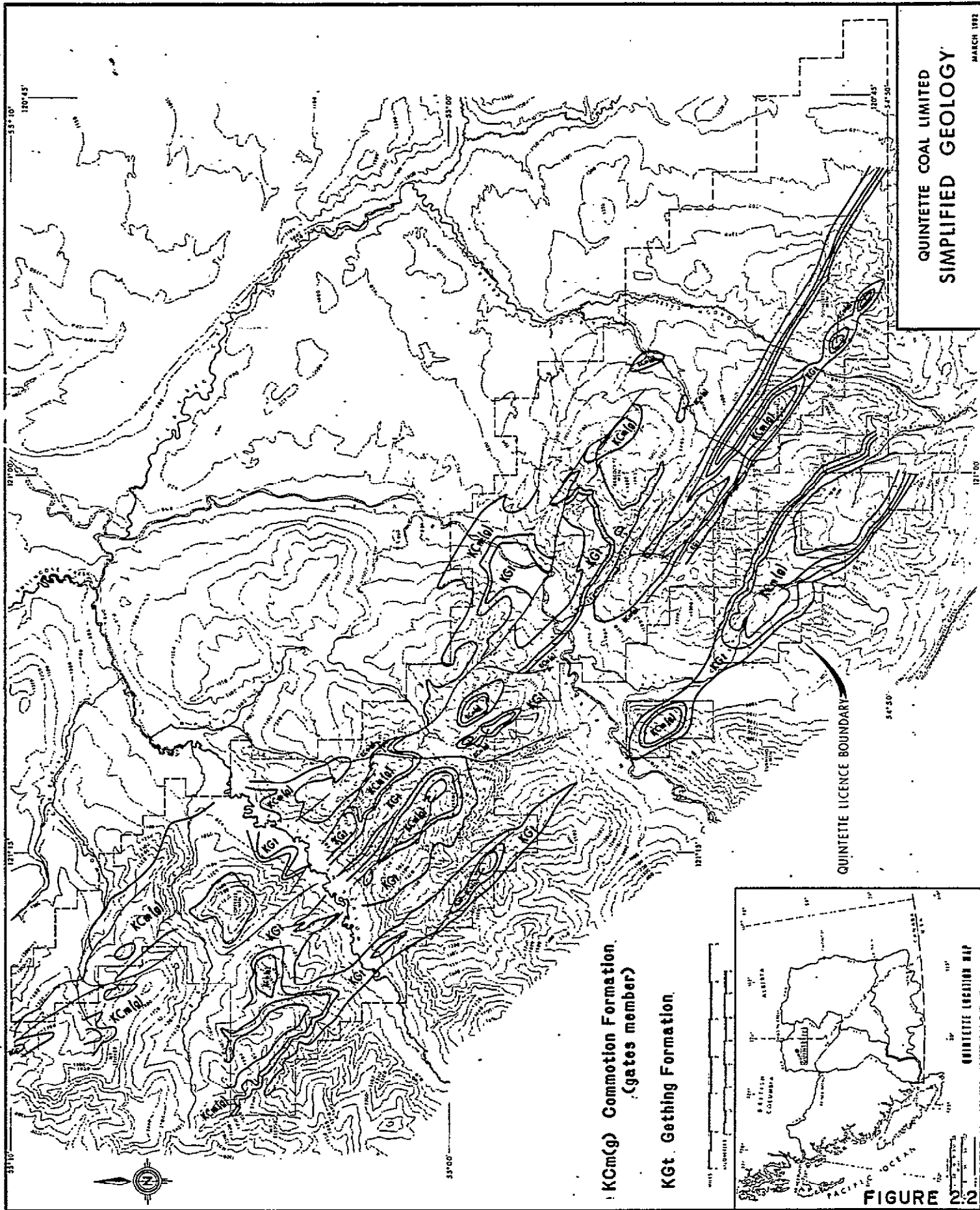

**QUINTETTE COAL LIMITED
SIMPLIFIED GEOLOGY**

MARCH 1992

**KCM(g) Compton Formation
(gates member)**

KGt Gething Formation

QUINTETTE LICENCE BOUNDARY

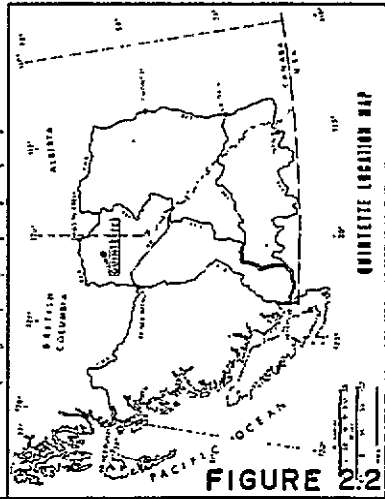

FIGURE 2.2

QUINTETTE LOCATION MAP

FRAME PIT *

McCONKEY PIT *

SHIKANO AREA *

BABCOCK AREA *

* QUINTETTE TREND SOUTH

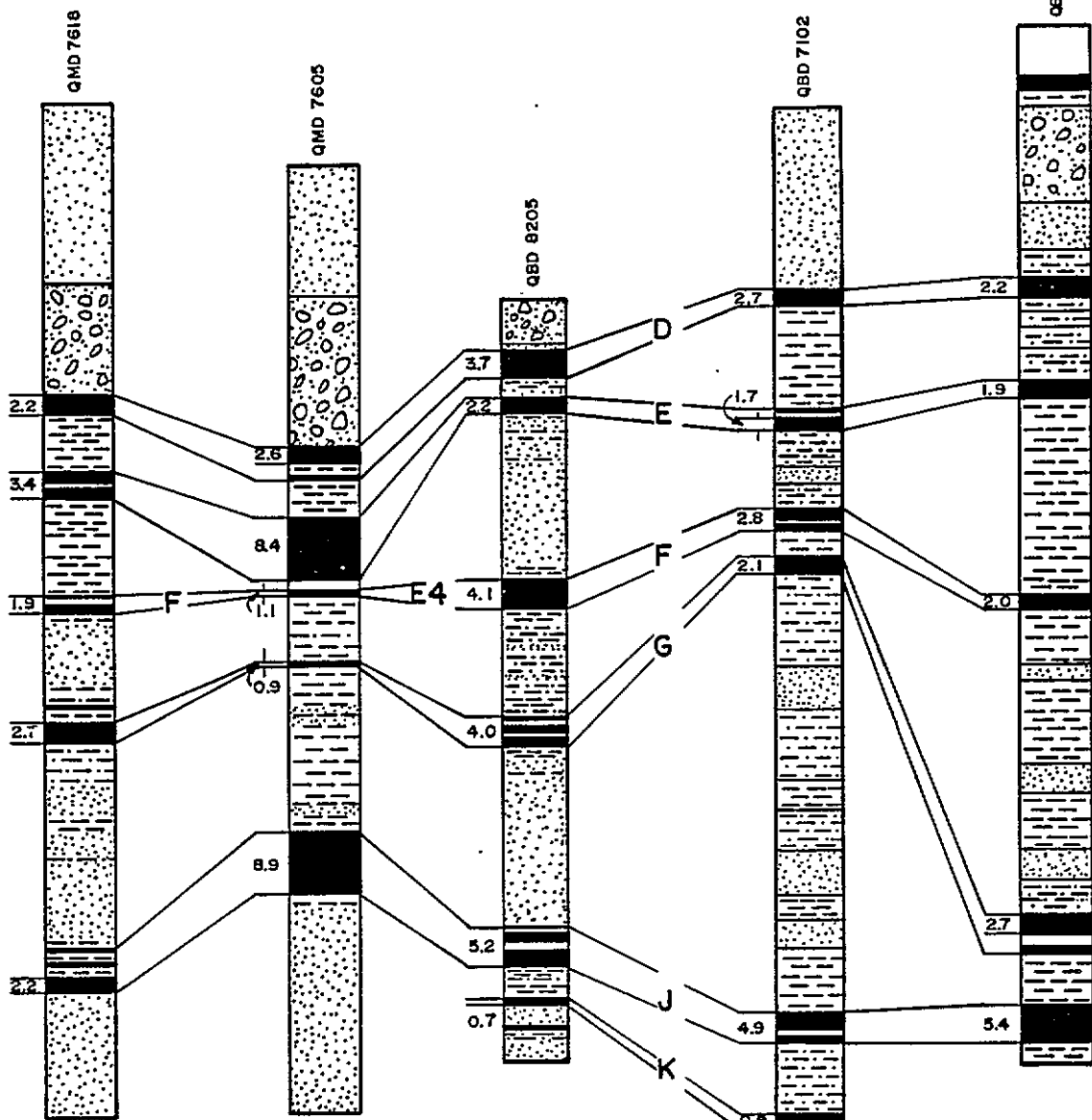

* NOTE: STRATIGRAPHIC COLUMNS FROM REGIONAL CORRELATION CHART

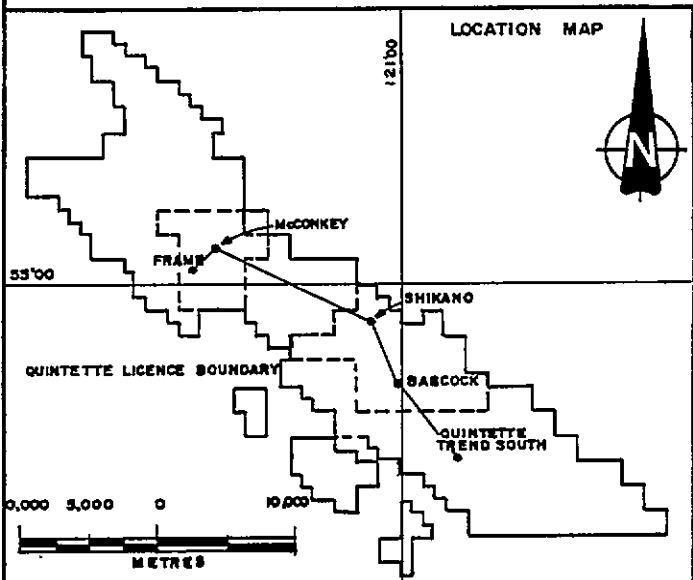

QUINTETTE COAL LIMITED
 MIDDLE GATES FORMATION
 REGIONAL STRATIGRAPHIC
 CORRELATION

FIGURE 2.3

APR./1985

2.2.1 Boulder Creek Formation

Although the Boulder Creek Formation does not exist within the currently planned pit limit, the strata will be intersected by planned waste dump access roads. The strata intersected is upwards of 80 metres in true thickness, and the lithologies identified are briefly summarized as follows:

<u>Section</u>	<u>Thickness</u>	<u>Predominant Lithology</u>
Upper	Up to 60 m	Shale with fine sst. interbeds
Middle	approx. 10-15 m	Shale
Lower	approx. 15-20 m	Very fine sandstones and conglomerates

The lower section is a very durable sequence which forms a resistant outcrop ridge north and northeast of the planned open pit.

2.2.2 Hulcross Formation

The Hulcross Formation attains a consistent thickness of approximately 85 metres. The strata is essentially characterized by homogeneous dark grey marine shales with sandy shale phases in the upper portion. Intermittent thin beds of sandstone, calcareous shale, and bentonite have been identified. The base of the formation is marked by a thin bed of pebble conglomerate or coarse sandstone. Owing to its high shale content, the Hulcross Formation has little or no definitive outcrop in the area. However, the formation's location is defined as the recessive strata which exists between the resistant, ridge forming conglomerate in the lower Boulder Creek Formation and the resistant, ridge forming conglomerates and sandstones in the upper sequence of the Gates Formation.

2.2.3 Gates Formation

The Gates Formation contains the economic coal seams in the Shikano area. The formation can be divided into three definitive portions: the upper, middle, and lower sequences. Of the three sequences, only the upper and middle are included in the currently planned pit.

- i) Upper Sequence

The Upper Sequence of the Gates Formation is defined from the base of the Hulcross Formation to the top of the first coal seam from which production is planned, namely D seam. This sequence is approximately 80 to 100 meters thick and is comprised of an upper and lower portion. The upper portion consists primarily of shale and minor sandy shales which represent a typical transitional zone. This upper portion attains a thickness of 35 meters. Three minor coal zones have been encountered in this sequence, and are usually referred to as A, B, and C seams. Seam A is commonly found just below the Hulcross - Gates contact. These seams have been termed "uneconomical" because of their thin inconsistent development. The lower portion of the sequence is characterized by very fine sandstones with interbeds of fine sandstones. A conglomeratic zone ranging in thickness from 4 to 25 metres usually forms the basal contact with the roof of D seam. On a regional scale the conglomerate is referred to as the Babcock Member, but on a more informal basis, the Quintette Operations personnel commonly refer to the conglomerate as the "Caprock". The conglomerate material represents certain inherent mining problems because of its highly resistant nature.

ii) Middle Sequence

The middle sequence of the Gates Formation ranges in thickness from 85 to 100 metres, and contains six coal zones from which all coal production is planned. The economical seams have been designated D, E2, F, G, J, and K1, from youngest to oldest, and are directly correlatable to the economic seams at Babcock. The middle sequence is defined as the strata from the roof of D seam to the floor of K2 seam. The strata lithologic variations and characteristics are illustrated on the Shikano Stratigraphic Correlation Charts presented in Section 1.2, Appendix 1. As shown on these charts, a pebbly conglomerate forms the major interseam lithology between seams F and G towards the north of the deposit. It is similar in nature to the channel conglomerates of the Babcock Member, and ranges in thickness from 0 - 28 metres. Table 2.1 summarizes the thickness ranges and general lithologies of the middle sequence interseam strata.

TABLE 2.1

SUMMARY OF INTERSEAM STRATA IN THE COAL BEARING SEQUENCE

<u>Interval</u>	<u>Thickness Range</u> Approx <u>(m)</u>	<u>General Lithology</u>
D seam to E seam	2 - 8	Shale; dark grey to very carbonaceous
E seam to F seam	20 - 24	Carbonaceous shales near E seam floor and F seam roof, with siltstone and fine sands in the middle.
F seam to G seam	11 - 29	Siltstone, shale, minor sandstones and conglomerate
G seam to J seam	18 - 28	Sandstone, siltstone, fining to shale near J seam roof
J seam to K seam	1.5 - 3.5	Shales

2.2.4 Shikano Coal Seam Development and Correlation

The continuity and development of seams D,E,F,G,J and K at Shikano have been confirmed by exploration to date. Each seam or seam-group comprises a mining section which varies according to individual coal seam development. Coal seam development and corresponding mining section thicknesses are illustrated on the Seam Correlation Charts in Supplement 2.2.4. The mining section thickness variations are further shown on Seam Isopach Maps presented in Section 1.4, Appendix 1, and summarized in Table 2.2.

D Seam

D seam is the uppermost, or youngest, seam included in the exploitable coal reserves in the Shikano Area. Figure 2.4 illustrates the characteristic seam development in Shikano. The seam contains two parting zones; an upper parting and a lower parting. The upper parting lies within 0.50 metres of the roof, and occurs as an intermittent, poorly developed zone. The lower parting is ubiquitous in Shikano, and is located within 1.0 metre of the seam floor. Both partings exhibit variable lithologies ranging from very carbonaceous to non-carbonaceous material. The immediate roof material of D seam is commonly identified as a massive conglomerate and sandstone. However, in several locations, a thin shale band separates the coal from the conglomerate. The floor of the seam consists of a hard, dark grey shale, but locally becomes a soft, carbonaceous shale. Generally, the roof and the floor seam contacts are sharply defined, but the floor contact becomes obscured where the lithology grades to a softer carbonaceous material. D seam represents a single mining section from roof to floor, and has an average thickness of 2.77 meters. Seam Correlation Charts in Supplement 2.2.4 fully illustrate the D seam development.

E Seam

E seam represents a group of seams or splits identified and illustrated in Figure 2.4 as E1, E2P, E2, E3P, and E3. This group is recognized throughout Shikano as depicted by the E Seam Correlation Charts in Supplement 2.2.4. The uppermost seam in the group, E1 seam, is a well defined coal seam approximately

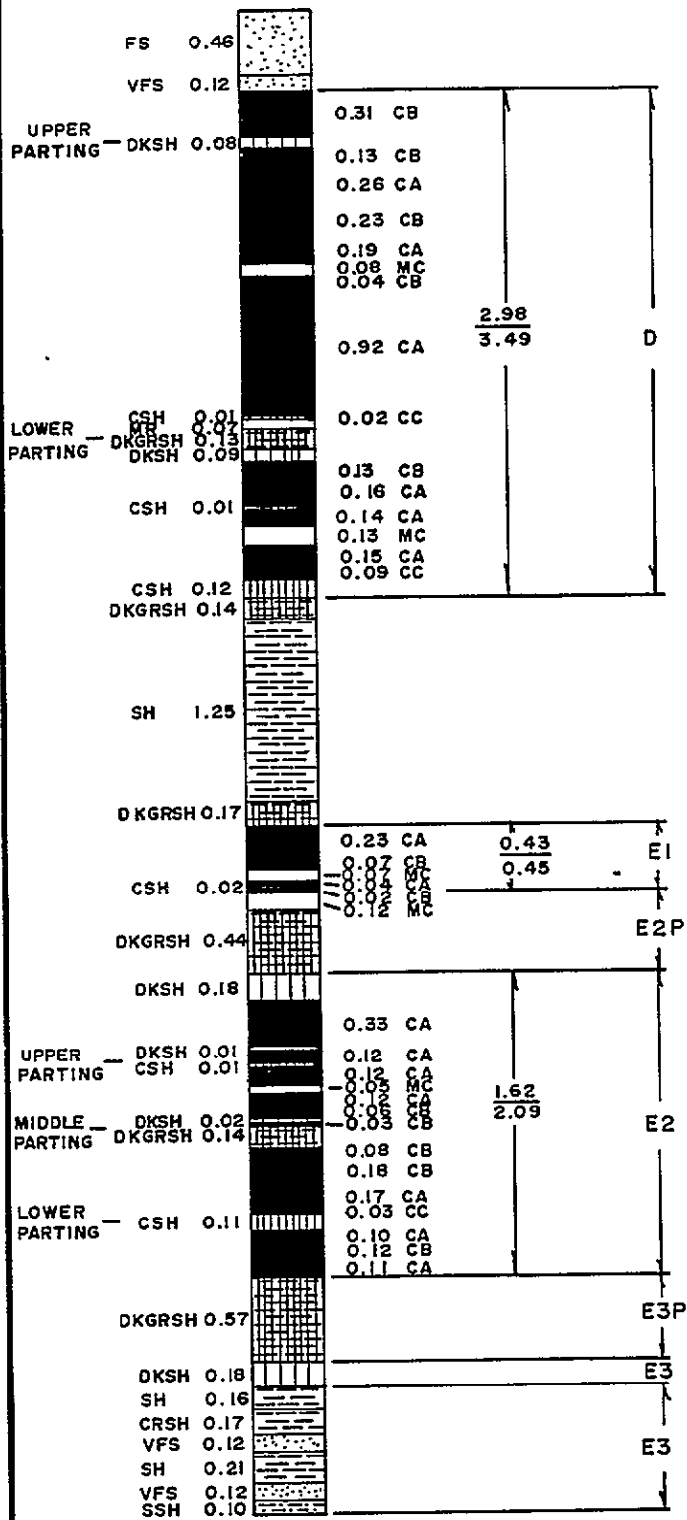

LEGEND

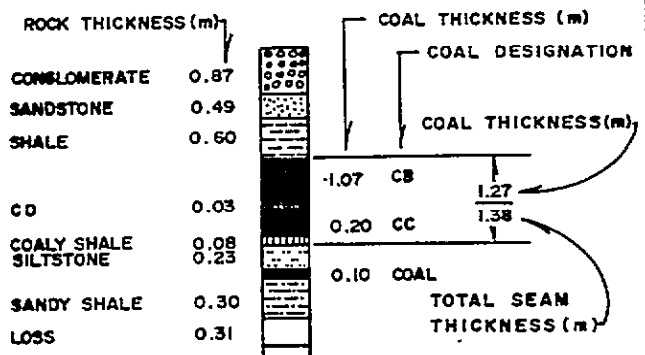

Date: 18/05/85
 Design: HTB
 Drawn: KJV
 Scale: 1:50

QUINTETTE COAL LIMITED
 Project Manager
DENISON MINES LIMITED
 COAL DIVISION



TYPICAL SECTION
 OF D, E1 & E2 SEAMS
 TAKEN FROM QSD85005

FIGURE 2.4
 Rev. 0

BCIL 7742 DCL

0.50 metres thick. A well developed parting designated as E2P separates E1 from E2 seam. E2P consists of a dark grey shale, locally carbonaceous, and is approximately 0.60 metres thick. E2 seam has been selected as the mining section within the E seam group. The mining section averages 2.14 metres in thickness, and includes three easily identifiable shale bands. Denoted as upper, middle, and lower partings, these bands are traced consistently within the planned pit area. Other partings occur locally, but are poorly developed. The roof material of E2 is comprised of E2P shale, and forms a competent, sharply defined contact with the coal. A grey to black shale produces a similar floor contact. Identified as E3P, the shale floor separates E2 from E3 seam. The thickness ranges from 0.24 to 0.71 metres. The stratigraphically lowest seam in the E group is E3 seam. Of little economic value, the seam mainly consists of a coally and carbonaceous material with an average thickness of 0.34 metres.

F Seam

F seam is well developed throughout Shikano with an average seam thickness of 4.08 meters. The columnar section depicted in Figure 2.5 is characteristic of seam development. As seen in Figure 2.5, the seam is divided into three portions: an upper, middle, and lower zone. The upper zone contains coal and a bone coal in roughly equal proportions; thicknesses range from 0.39 to 0.70 meters. This zone is the equivalent to the boney coal in F seam at Babcock Mountain. The middle zone comprises the major portion of the seam, and includes two to four minor partings towards the lower middle. Parting lithologies grade from shale to bone coal. The coal itself contains abundant vitrain layers. The middle and upper zones of F seam comprise the F seam mining section. The lower zone comprises the footwall material of F seam mining section. The lithology consists of a durable, dark grey shale, but locally become a soft coally and carbonaceous shale. Where the soft carbonaceous shale occurs, the floor contact becomes obscured. Otherwise, both the floor and the roof contacts are clearly delineated. F Seam Correlation Charts in Supplement 2.2.4 fully illustrate F seam development and variation.

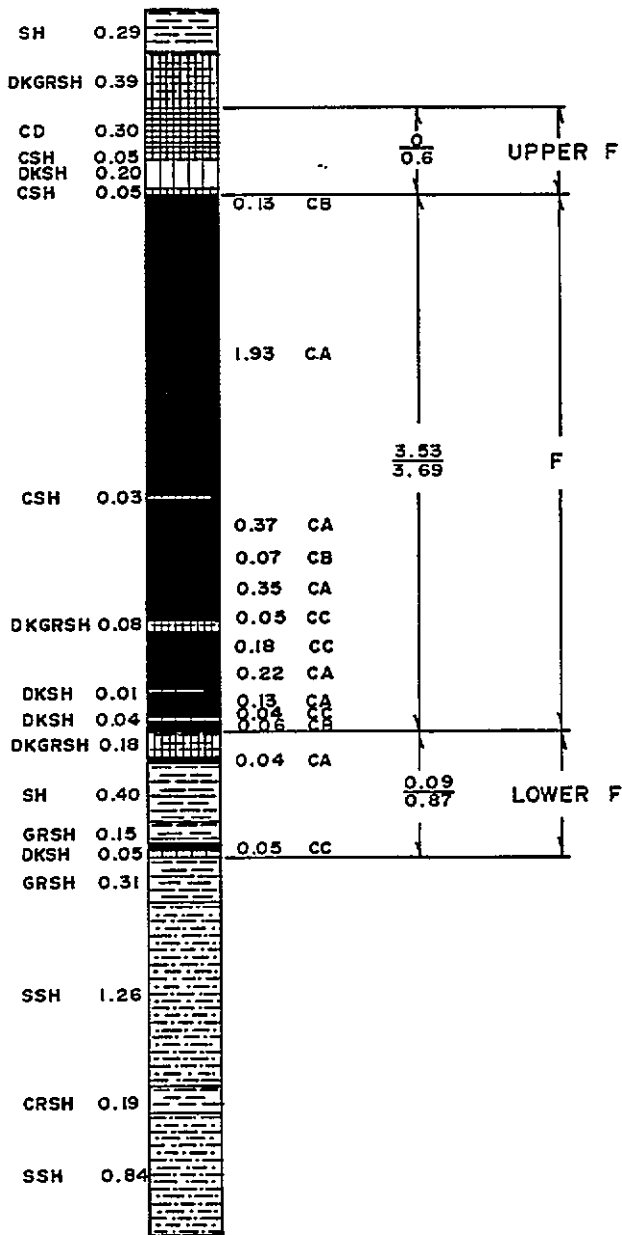

LEGEND

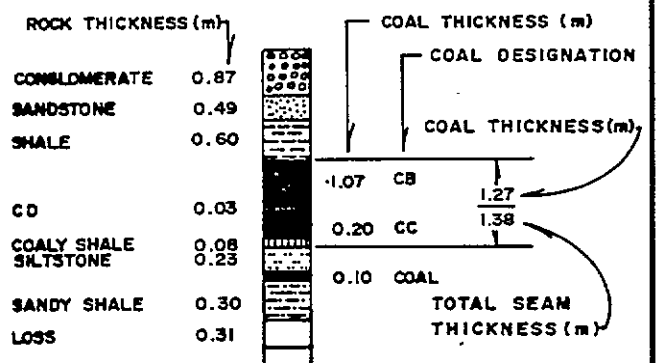

Date: 18/05/85
 Design: HTB
 Drawn: KJV
 Scale: 1:50

QUINTETTE COAL LIMITED
 Project Manager
DENISON MINES LIMITED
 COAL DIVISION

TYPICAL SECTION OF F SEAM
 TAKEN FROM QSD85005
 FIGURE 2.5
 Rev. 0

BCIL 7742 OCL

SUMMARY - BULK WASHING DATA (Cont.)

Bulk Sample F SEAM - SECOND MET Lab.No. 3256

FROTH FLOTATION CIRCUIT

Flotation Cell: two (2) Birtley-Humboldt Multi-Wobble
impellers in series.

Reagent: 4:1 = Kerosene: M.I.B.C.

Thickening Cyclone: 20⁰ - 8" cyclone Hayl-Patterson

1. Thickening Cyclone Overflow (T.C.O. -325M)	<u>18.2</u>	ASH%	<u>1</u>	FSI
2. Flotation Feed (Thickening Cyclone Underflow)	<u>13.3</u>	ASH%	<u>7½</u>	FSI
3. Concentrate	<u>9.3</u>	ASH%	<u>8</u>	FSI
4. Tailings	<u>48.2</u>	ASH%	<u>0</u>	FSI
5. Yield Concentrate =	$\frac{48.2 - 13.3}{48.2 - 9.3}$	=	<u>89.7</u>	%

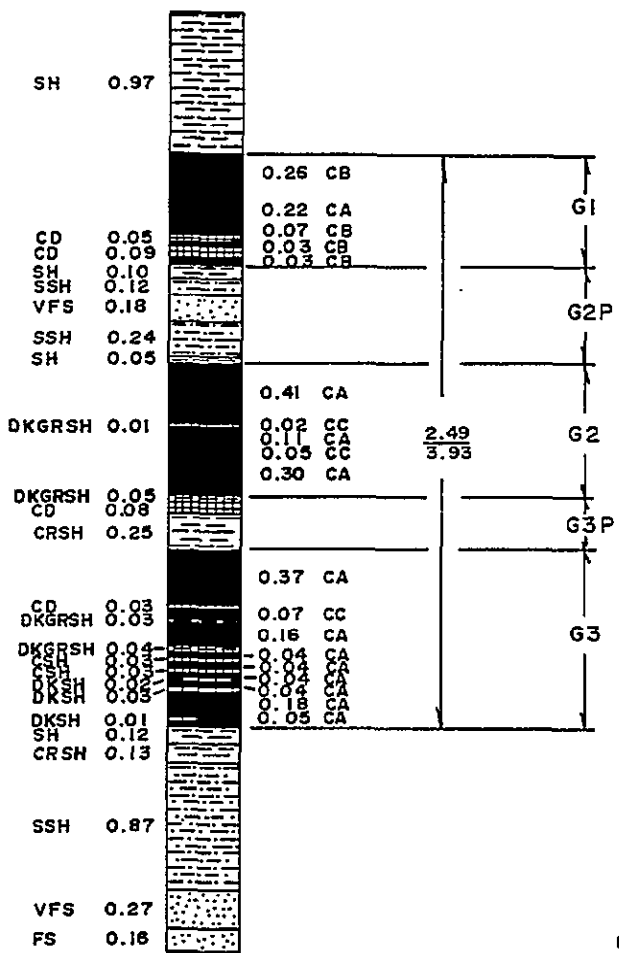

LEGEND

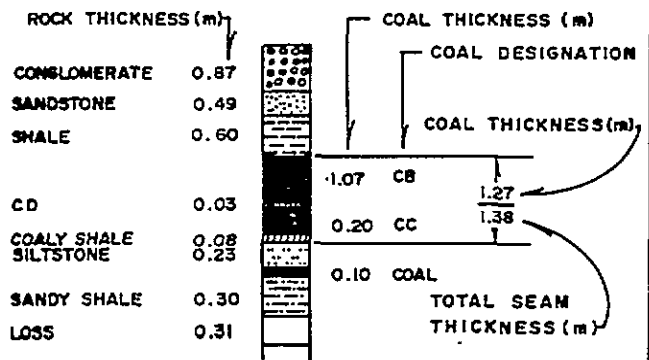

Date: 18/05/85
 Design: HTB
 Drawn: KJV
 Scale: 1:50

QUINTETTE COAL LIMITED
 Project Manager
DENISON MINES LIMITED
 COAL DIVISION



TYPICAL SECTION
 OF G SEAM
 TAKEN FROM QSD85005

FIGURE 2.6
 Rev. 0

BCIL 7742 OCL

SH 2.10

DKSH 0.12
DKSH 0.02
CSH 0.03
SH 0.19
DKSH 0.05
DKGRSH 0.04
DKSH 0.03
DKSH 0.03
DKGRSH 0.10
DKGRSH 0.03

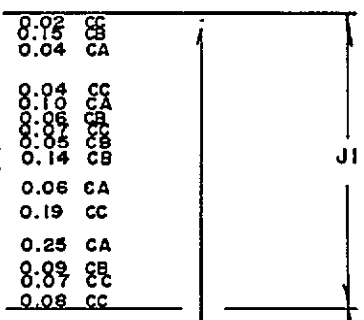

CD 0.07
SH 0.36
DKSH 0.03
DKGRSH 0.04
DKGRSH 0.33
DKGRSH 0.11
CSH 0.06
CD 0.09

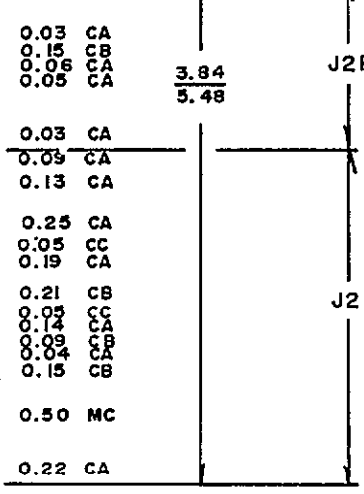

DKGRSH 0.36
SH 0.11
MR 0.09
DKGRSH 0.08
DKGRSH 0.04
DKGRSH 0.05
DKGRSH 0.03
DKGRSH 0.03
DKGRSH 0.03
DKGRSH 0.03
DKGRSH 0.03
DKGRSH 0.03
DKGRSH 0.03

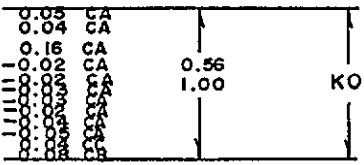

SH 0.18
CRSH 0.05
SSH 0.18
SH 0.09
GRSH 0.44
SH 0.18
CRSH 0.69
CSH 0.02

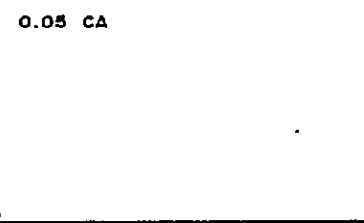

LEGEND

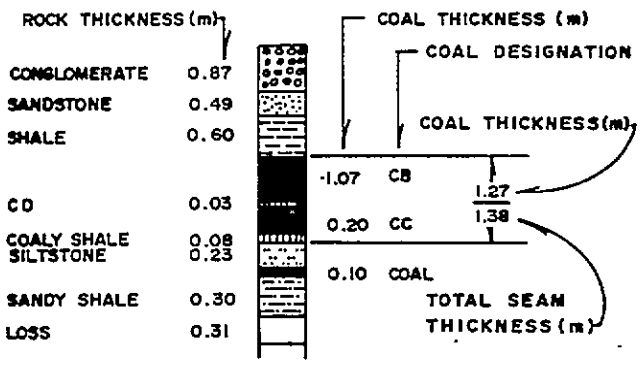

Date: 18/05/85

Design: HTB

Drawn: KJV

Scale: 1:50

QUINTETTE COAL LIMITED

Project Manager
DENISON MINES LIMITED
 COAL DIVISION



TYPICAL SECTION
 OF J1, J2&KO SEAMS
 TAKEN FROM QSD85005

FIGURE 2.7

Rev. 0

BCIL 7742 OCL

diversified seam development in terms of variable shale content. In the south, shale bands comprise upwards of 40% of the seam's thickness, but to the north they decrease to less than 20%. Of all the shale bands, only two partings persist throughout the deposit. These partings are located within 0.50 metres of the seam roof and within 0.50 metres of the seam floor. The J1 seam thicknesses average 1.85 metres. J2P represents the major parting that separates J1 from J2 seam. The parting consists of two rock bands with an intervening coal split. The rock lithologies vary from a carbonaceous shale to a sandy shale or fine sandstone; J2P thicknesses average 0.67 metres. The lowermost seam, J2 seam, is well developed throughout the pit with an average thickness of 2.28 metres. Partings within J2 have been identified, but they are poorly developed. Some of the J2 coal is identified as dull and hard. The total collection of the above seams and partings comprises the J seam mining section. The mining section thickness, as seen in the J seam Isopach Maps in Section 1.4, Appendix 1, is regular throughout most of the pit area, except in the south. Here, J2P has been excluded from the J seam mining section because of its thickness and low coal content. Hence, the mining section is divided into both J1 and J2 seams. The J seam roof material varies from a dark grey to grey shale, and forms a very distinct contact with the coal. The floor material is characterized by a sandy shale, and the contact is clearly delineated. The average J seam mining thickness is 4.79 meters. Seam development and variation are shown by the J Seam Correlation Charts in Supplement 2.2.4.

K Seam

K seams represent the stratigraphically lowest coal zone within Shikano. The zones development is recognized throughout the pit as shown in the K Seam Correlation Charts in Supplement 2.2.4. The coal zone comprises 2 to 3 coal seams identified as K0, K1, and K2 seams. Only K1 seam is considered as an exploitable reserve. Figure 2.7 depicts the characteristic K1 seam development. As seen in this figure, the seam is well defined with little, or no, shale bands; seam thicknesses average 0.87 metres. The seam's roof material mainly consists of a dark grey to carbonaceous shale, but in some areas the roof lithology is dominated by the K0 coal seam. The K0 seam consists of coally and carbonaceous shale of little economic value. The thickness ranges from 0.53 to 1.52 metres. The K1 floor material consists of

shale to sandy shale which forms a clear contact with the coal. The K1 seam mining section is defined as the coal section located between its respective roof and floor contacts. K2 seam lies approximately 3 meters below the floor of K1 seam. The seam is extremely well defined, and can be traced throughout Shikano; thicknesses average 0.57 meters.

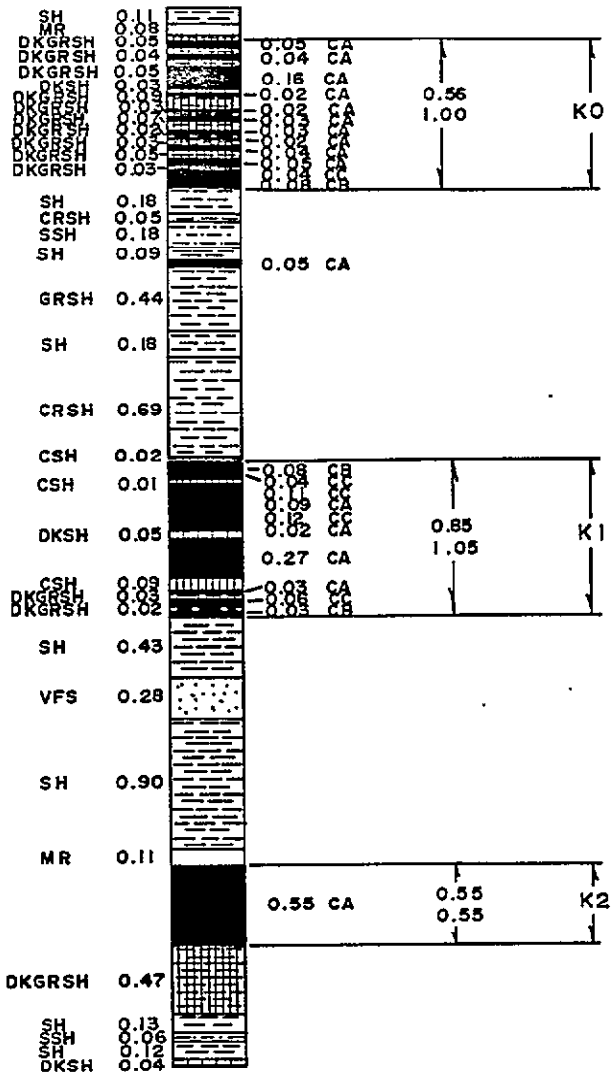

LEGEND

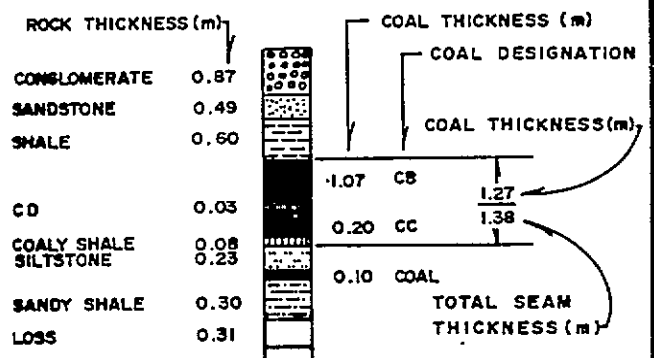

Date: 18/05/85
 Design: HTB
 Drawn: KJV
 Scale: 1:50

QUINTETTE COAL LIMITED
 Project Manager
DENISON MINES LIMITED
 COAL DIVISION

TYPICAL SECTION
 OF K0, K1 & K2 SEAMS
 TAKEN FROM QSD85005
 FIGURE 2.8
 Rev. 0

BCL 7742 OCL

TABLE 2.2

SEAM THICKNESS SUMMARY
SHIKANO

<u>Seam</u>	Thickness (m)			Weighted Average <u>Thickness (m) *</u>
	<u>Minimum</u>	<u>Maximum</u>	<u>Range</u>	
D	1.18	3.49	2.31	2.77
E	1.53	2.40	0.87	2.14
F	3.66	4.63	0.97	4.08
G	2.43	3.96	1.53	3.22
J	3.89	5.42	1.53	4.79
K	0.55	1.23	0.68	0.87

* Average thicknesses represent Shikano Main only.

2.3 REGIONAL STRUCTURE

The regional geologic structure within the Shikano area is best illustrated by Figure 2.9. This figure shows that the primary structural features are characterized by broad synclines and sharper anticlines which are often separated by medium to high angle thrust faults. The potential for open pit mining within these areas is excellent where the coal-bearing Gates Formation outcrops. The location of the proposed Shikano pit is a typical example. In addition to this location, similar structures containing coal bearing strata outcrop directly across the Murray River at Hermann South. To a lesser degree, a continuation of the M-9 syncline-anticline structure could occur towards the southeast from the Shikano pit. Further geologic exploration of these areas could indicate excellent reserve potentials.

2.4 SHIKANO STRUCTURE

The primary structural feature of the Shikano deposit comprises an asymmetrical syncline-anticline fold pair that plunges 15° to the southeast. They are identified as the Shikano Anticline and the Shikano Syncline. Of the two folds, the syncline lies more to the southwest and exhibits a more open fold style. This fold is characterized by northeastern and southwestern dipping limbs. The northeastern dips range from 15 to 30 degrees; the southwestern dips are much steeper at 30 to 60 degrees. In conjunction with the southwestern inclined limb, another more northern, northeastern dipping limb completes the anticline fold structure. This limb has a dip angle range from 30 to 45 degrees. Both fold structures exhibit tectonic distortion of the coal seams and interseam strata near their respective hinges. Further and greater disruption of the seams and strata occurs from fold associated fault zones, especially within the syncline and near the fold pairs shared limb. The majority of the faults have been interpreted as reverse, or thrust, faults with estimated maximum vertical displacements upwards of 15 meters. A normal fault of similar displacement has been confirmed. Numerous fault displacements of lesser magnitude, 0 to 2 meters, have been noted throughout the pit area, but they are currently interpreted as intraplanar movement within the coal seams only.

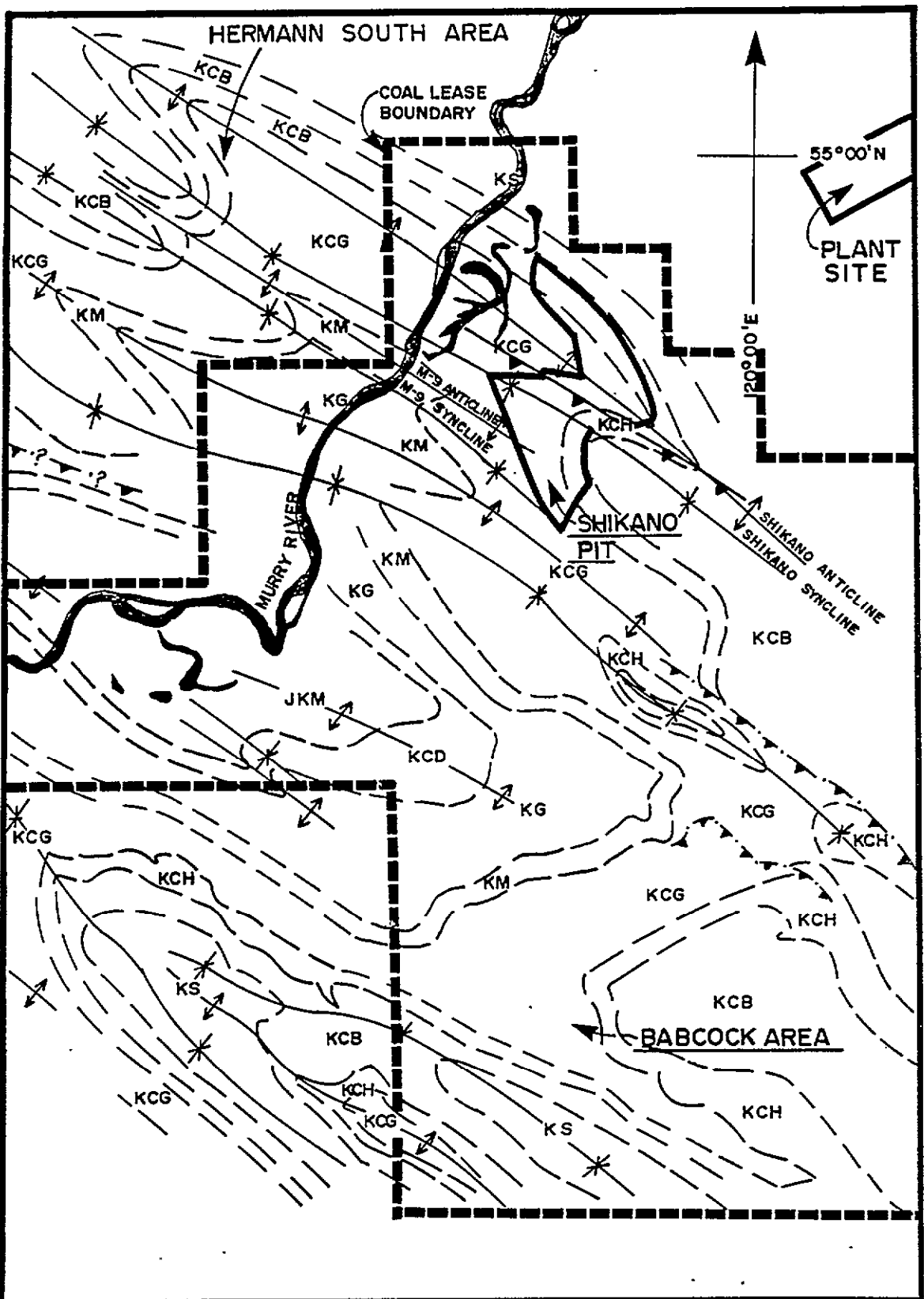

DATE :	03 / 05 / 85
DESIGN :	DJ
DRAWN :	EJP
SCALE :	1 : 50 000

QUINTETTE COAL LIMITED

REGIONAL GEOLOGICAL STRUCTURE OF THE SHIKANO RESERVE AREA

DRAWING NO. **FIGURE 2:9** REV

In addition to the primary fold structures, a second similar fold structure of lesser magnitude has been delineated near the southwestern limit of the present Shikano study area. Denoted as the M-9 syncline-anticline, these folds exhibit axial plunges at 10 degrees towards the northwest - exactly opposite to the primary fold plunge direction. Owing to the erosional state of the strata in the M-9 area, only G, J, and K seams are presently confirmed within this structure. Associated faulting has been confirmed by drilling. Fault displacements range from 0 to 5 meters.

Generally, the geologic structure is very continuous in Shikano, except near the primary fold axes and this fold pairs common limb where the strata is disrupted by the folds and associated faults. The Geology maps and associated geology cross sections in Supplement 2.2.4 illustrate the Shikano structure. Top of seam structure contours and mining sections in Section 1.1 and Section 1.6, Appendix 1, further depict the Shikano structures.

SECTION 3.0

QUALITY

Section 3 of this report contains coal quality data, and remains confidential under the terms of the *Coal Act Regulation*, Section 2(1). It has been removed from the public version.

http://www.bclaws.ca/EPLibraries/bclaws_new/document/ID/freeside/10_251_2004

SECTION 4.0

RESERVES

4.0 SHIKANO RESERVES

The product coal reserves contained within the area limited by the May 1985 Shikano Pit include 7.4 million tonnes of metallurgical coal and 1.2 tonnes of thermal coal. Metallurgical coal will be produced at 9.5% ash and 8% total moisture, and the oxidized coal, also known as thermal coal, will be produced at 10.0% ash and 8% total moisture. Tables 4.1a and 4.1b summarize the calculated Shikano coal reserves. As recorded on these Tables, the reserves are calculated for the Shikano Main area and the M-9 Extension area. Figure 4.1 illustrates each reserve area.

4.1 RESERVE CALCULATIONS METHOD

Detailed coal reserves were calculated by the Minepak Computer System which used a series of gridded seam files to allow greater flexibility for modelling the geologic information. Each cell in the gridded seam model consists of a rectangular area and represents a plan area portion of one seam. In the present reserve calculation, cell dimensions of 10 x 10 meters were used. These cells can be stacked to represent multiple seams. Once the Shikano computer database was defined and filled with available information, interpolation programs were run to provide mining section thickness, in-place ash, and structure for the individual cells in the seam model. Kriging was the primary interpolation tool used. At this stage, results were verified and adjusted as required. A complete reserve estimate for each seam was then determined via a series of reserve programs. Moreover, the reserve programs divided each seam reserve into both thermal (oxidized) and metallurgical coal. As seen in Figure 4.2, the oxidized coal was determined as all coal within a 15 meter vertical zone from the bedrock surface. This zone was established by examining the oxidation characteristics from available analytical data. From a long range perspective, the 15 meter zone provides a conservative estimate of the metallurgical versus the oxidized coal proportion. Under short range mining conditions, further oxidation delineation will proceed using procedures established at McConkey and Frame.

The number of cells used for the reserve estimation was limited to the region bounded by the May 1985 Shikano pit. The pit configuration is illustrated in Figure 4.1

22300.0

23300.0

24300.0

MURRAY RIVER 760 m ELEV.

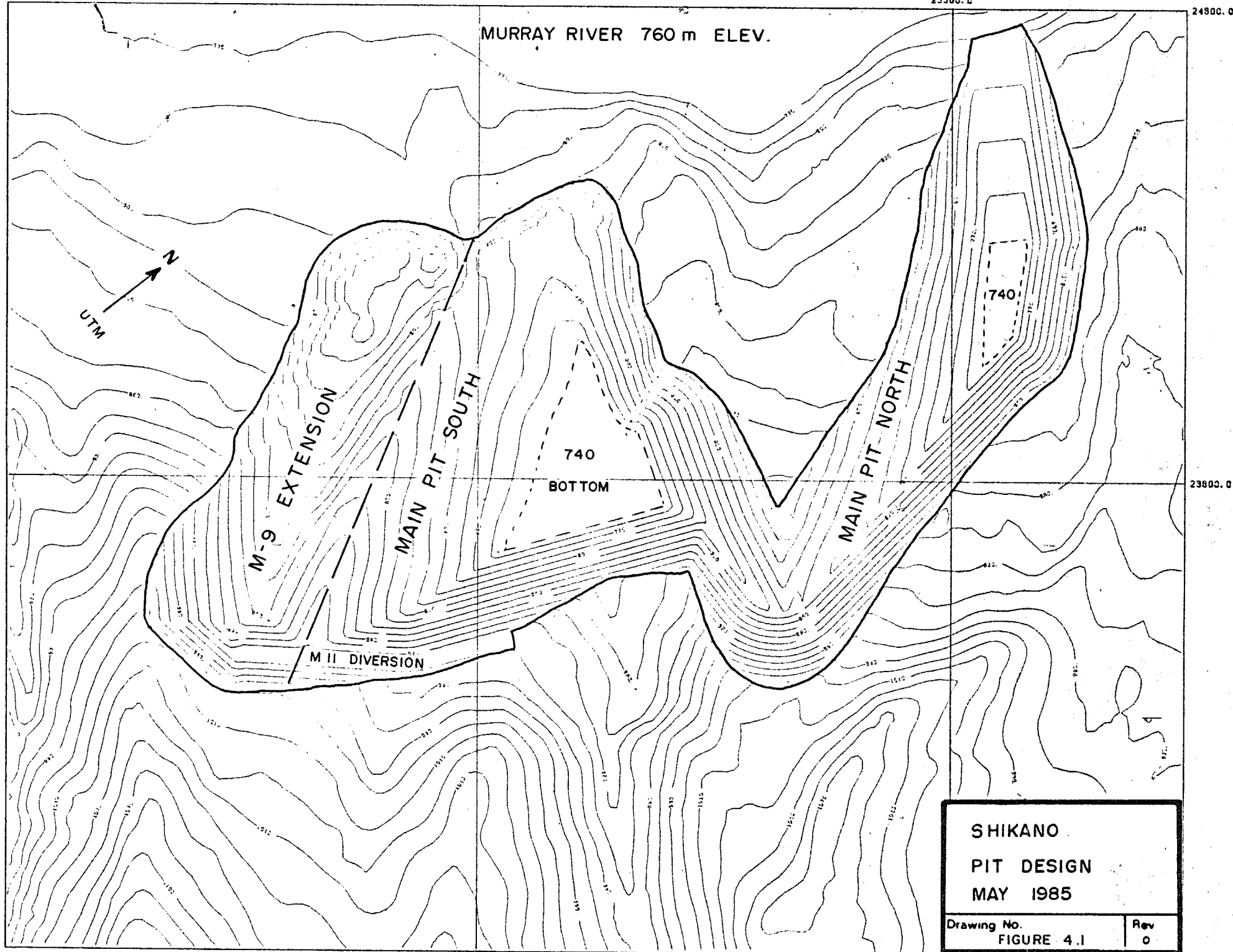

SHIKANO
PIT DESIGN
MAY 1985



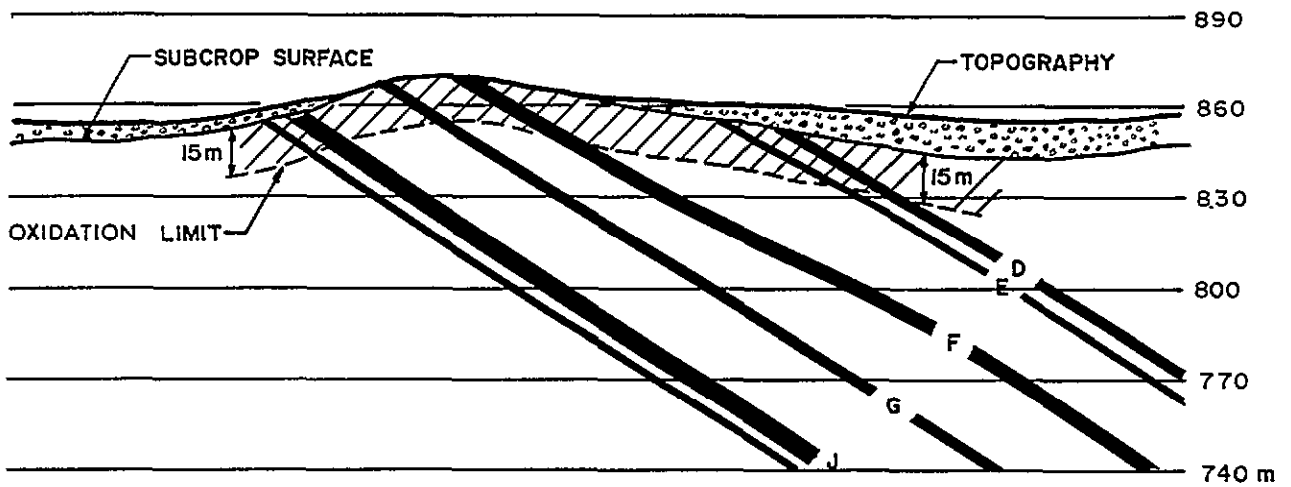

Drawing No.
FIGURE 4.1

Rev
0

22800.0



Legend

-  Coal Seam
-  Topography and Subcrop Surface
-  Surficial Deposit (overburden)
-  Oxidation Limit
-  Oxidized Zone

Date: 24/05/85

Design: KTJ

Drawn: JHK

Scale: 1:2500

QUINTETTE COAL LIMITED

Project Manager

DENISON MINES LIMITED

COAL DIVISION



Oxidization
Limit

FIGURE 4.2

Rev.

BCIL 7742 OCL

TABLE 4.1a

SHIKANO RESERVE SUMMARYSHIKANO MAINMETALLURGICAL COAL

<u>SEAM</u>	<u>THICKNESS (m)</u>	<u>HEAD ASH %</u>	<u>DRY ROM TONNES (1,000s)</u>	<u>DRY PLANT FEED YIELD %</u>	<u>WET PRODUCT TONNES (1,000s)</u>
D	2.78	15.70	740	78.9	595
E	2.13	24.34	615	58.4	359
F	4.09	18.23	1,983	73.4	1,501
G	3.22	40.72	2,262	46.6	1,060
J	4.78	27.50	3,649	65.8	2,468
K	<u>0.88</u>	<u>14.43</u>	<u>777</u>	<u>69.9</u>	<u>508</u>
TOTAL	17.88	26.29	10,026	63.8	6,491

THERMAL

D	2.74	15.07	312	70.6	224
E	2.17	24.22	267	49.7	133
F	4.04	18.57	443	63.7	291
G	3.22	39.95	387	38.5	150
J	4.92	26.38	355	58.3	213
K	<u>0.84</u>	<u>14.78</u>	<u>62</u>	<u>59.8</u>	<u>35</u>
TOTAL	17.93	24.72	1,826	56.4	1,046

Waste - 59,615,600 BCM

* Note: The Shikano Main Reserves exclude any pit optimization adjacent to the M-9 Extension.

TABLE 4.1b

SHIKANO RESERVE SUMMARYSHIKANO M-9 EXTENSIONMETALLURGICAL COAL

<u>SEAM</u>	<u>THICKNESS (m)</u>	<u>HEAD ASH %</u>	<u>DRY ROM TONNES (1,000s)</u>	<u>DRY PLANT FEED YIELD %</u>	<u>WET PRODUCT TONNES (1,000s)</u>
G	3.26	38.12	261	49.5	130
J	4.41	31.93	988	59.8	604
K	<u>0.74</u>	<u>19.72</u>	<u>262</u>	<u>61.2</u>	<u>147</u>
TOTAL	8.41	30.88	1,511	58.2	881

THERMAL

G	3.40	40.93	175	37.5	66
J	4.67	30.42	185	52.9	100
K	<u>0.71</u>	<u>18.40</u>	<u>35</u>	<u>52.9</u>	<u>17</u>
TOTAL	8.78	34.00	395	46.1	183

Waste - 11,996,700 BCM

4.1.1 In-Place Reserve Calculation

The in-place reserves were calculated from combination of the mining section thickness, in-place ash, the dip angle, and the 100 square meter cell area.

First, the volume was calculated as shown in Equation 1.

$$\begin{aligned} \text{Equation 1) In-place Volume} &= \text{Vol}_{(I.P.)} \\ \text{Block Area} &= 10 \times 10 = 100 \text{ m}^2 \\ \text{Mining Section Thickness} &= V_TTHICK \\ \text{Vol}_{(I.P.)} &= \frac{V_TTHICK \times \text{AREA}}{\text{COS (DIP ANGLE)}} \quad (10) \end{aligned}$$

The inverse of the COS (DIP ANGLE) corrects the plan area for structural slope. From the in-place ash, the relative specific gravity was calculated using equation 2.

$$\begin{aligned} \text{Equation 2) In-place ash \% or Head ash \%} &= \text{HASH} \\ \text{Specific Gravity of In-place Ash} &= \text{S.G. (HASH)} \\ *S.G. (HASH) &= \frac{211.4306}{172.0854 - \text{HASH}} \end{aligned}$$

* Reference the Quintette Feasibility Study, March, 1981,
Volume III; p. 3.2.1-6

Then, by combining equation 1 and 2 into equation 3, the in-place reserve was determined.

$$\begin{aligned} \text{Equation 3) In-place Tonnes} &= \text{Tonnes}_{(I.P.)} \\ \text{Tonnes}_{(I.P.)} &= \text{Vol}_{(I.P.)} \times \text{S.G. (HASH)} \end{aligned}$$

4.1.2 Run-of-Mine Reserve Calculation

For Shikano, the run-of-mine (ROM) tonnes was defined as a combination of the in-place tonnes, out-of-seam dilution (OSD) tonnes, the mining loss, and the geological loss. The OSD was construed as 15 centimetres true thickness of

rock per mining section. The rock ash was set at 90.6%. Tonnes of OSD were calculated the same as the in-place tonnes. Mining loss was defined as the estimated loss of ROM reserve due to mine operating conditions. The estimated mining loss was set at 10%. To compensate for variable geologic conditions within the pit, a geological loss of 5% was used. The geological loss was also construed as a geological confidence factor of 0.95. The planned ROM reserve, on an air-dried basis, was calculated as seen in Equation 4.

$$\begin{aligned}
 \text{Equation 4) Run-of-mine} &= \text{ROMTNE} \\
 \text{Out-of-seam dilution tonnes} &= \text{TONNES}_{(\text{OSD})} \\
 \text{Mining Loss Factor} &= 0.90 \\
 \text{Geological Confidence Factor} &= 0.95 \\
 \text{ROMTNE}_{(1)} &= (\text{Tonnes}_{(\text{I.P.})} + \text{Tonnes}_{(\text{OSD})}) \times 0.90 \times 0.95
 \end{aligned}$$

The computer model generated the ROM reserve on a dry basis. Therefore, a correction factor of 0.9945 to compensate for 0.55% residual moisture was used (For ROM reserves on a wet basis, 6% total moisture content was included).

Often, the OSD is reported as percentage of the ROM reserve. Equation 5 depicts the calculation used to determine OSD percent.

$$\text{Equation 5) OSD \% of Total ROM Tonnes} = \frac{\text{Tonnes}_{(\text{OSD})}}{\text{Tonnes}_{(\text{I.P.})} + \text{Tonnes}_{(\text{OSD})}}$$

To quantify the change from in-place ash to ROM ash, an ash/mass balance was used to determine ROM ASH as seen in Equation 6.

$$\begin{aligned}
 \text{Equation 6) ROM ASH} &= \text{RASH} \\
 \text{OSD ASH \%} &= 90.6\% \\
 \text{RASH} &= \frac{\text{Tonnes}_{(\text{I.P.})} \times \text{HASH} + \text{Tonnes}_{(\text{OSD})} \times 90.6}{\text{Tonnes}_{(\text{I.P.})} + \text{Tonnes}_{(\text{OSD})}}
 \end{aligned}$$

4.1.3 Plant Feed Reserve Calculation

Plant feed tonnes were interpreted as the coal reserve that enters the washplant. The planned Plant Feed reserves result from processing ROM Coal in a Bradford Breaker. By passing the ROM reserve through a Breaker System, the ROM ash content is reduced to the Plant Feed ash level by rejecting the large, durable, high ash material. To quantify the Bradford's effective improvement, a performance evaluation of the present system installed at the McConkey and Frame Pits was completed which allows for the prediction of Plant Feed ash and tonnage. The Plant Feed tonnage is derived through the application of equation 7, 8 and 9.

$$\text{Equation 7) Reject Percent} = 0.10 (\text{HASH \%}) + 0.50 (\text{OSD \%})$$

$$\text{Equation 8) Reject Tonnes} = \text{Tonnes}_{(\text{REJ})}$$

$$\text{Tonnes}_{(\text{REJ})} = \frac{\text{Reject \%} \times \text{ROMTNE}}{100}$$

$$\text{Equation 9) Plant Feed Tonnes} = \text{PFTNE}$$

$$\text{PFTNE} = \text{RMTNE} - \text{REJ.TONNES}$$

The associated plant feed ash value was also determined using Equation 10.

$$\text{Equation 10) PLANTFEED ASH} = \text{PFASH}$$

$$\text{Bradford Reject Ash} = 80\%$$

$$\text{PFASH} = \frac{\text{RMTNE} \times \text{RASH} - \text{REJ.TONNES} \times 80.0}{\text{PFTNE}}$$

Table 4.2 presents a seam by seam summary of the progressive ash calculations from in-place to plant feed in addition to plant feed yields.

4.1.4 Product Reserve Calculation

A washplant simulator computer program was used to predict metallurgical coal yields. Since yield is a function of both seam washability characteristics and ash content, equations were derived for each seam to relate the calculated yield to the plant feed ash level. The plant yield was based upon a 9.5% product ash. The equations derived from this analyses are presented on Table 4.3. By applying these equations to their respective calculated Plant Feed ashes, predicted dry plant yields were established. These yields were then applied against the plant feed reserves to calculate the dry product reserves at 9.5% ash. For the thermal coal feed, plant yields are also based upon the same ash versus yield relationships. However, the yield was reduced a further 9 percent to properly represent the lower thermal plant efficiency. A wet yield for both thermal and metallurgical coal can then be calculated by adding 8% moisture as per contract specification.

i) Theoretical Plant Yield % - original washability data yield estimate without any adjustment factors.

ii) Dry Overall yield % = $\frac{\text{Product Tonnes (Dry)}}{\text{ROM Tonnes (Dry)}} \times 100$

iii) Dry Plant Feed Yield % = $\frac{\text{Product Tonnes (Dry)}}{\text{Plant Feed Tonnes (Dry)}} \times 100$

TABLE 4.2

**SHIKANO
ASH AND YIELD SUMMARY**

METALLURGICAL COAL

<u>Seam</u>	<u>Insitu Ash (%)</u>	<u>ROM ASH (%)</u>	<u>PLANT FEED ASH (%)</u>	<u>DRY PLANT FEED YIELD (%)</u>
D	15.70	22.74	18.91	78.90
E	24.34	31.84	27.60	58.40
F	18.23	22.92	19.88	73.40
G	40.72	44.24	41.31	46.60
J	27.50	30.84	28.04	65.80
K	14.43	33.39	25.87	69.90

THERMAL

D	15.07	22.29	18.43	70.60
E	24.22	31.63	27.43	49.70
F	18.57	23.29	20.22	63.70
G	39.95	43.53	40.57	38.50
J	26.38	29.71	26.93	58.30
K	14.78	34.21	26.57	59.80

Note: Yields based upon Shikano Main area only.

TABLE 4.3

PREDICTED METALLURGICAL DRY PLANT FEED YIELD EQUATION

<u>SEAM</u>	<u>EQUATION</u>	<u>CORRELATION COEFFICIENT</u>
D	Plant Feed Yield = 106.5 - 1.458 (PFASH)	0.975
E2	Plant Feed Yield = 108.0 - 1.797 (PFASH)	0.955
F	Plant Feed Yield = 112.3 - 1.959 (PFASH)	0.866
G	Plant Feed Yield = 94.5 - 1.159 (PFASH)	0.953
J	Plant Feed Yield = 104.7 - 1.388 (PFASH)	0.986
K	Plant Feed Yield = 109.4 - 1.527 (PFASH)	0.956

Note: 1. Thermal Plant Feed Yield = Met Plant Feed Yield - 9

SECTION 5.0

GEO TECHNICAL STUDIES

5.0 GEOTECHNICAL STUDIES

5.1 INTRODUCTION

This section describes the geotechnical and hydrogeological studies carried out for the design of open pit slopes and waste dumps for Quintette Coal Limited's proposed Shikano Project. The terms of reference for these studies are outlined in QCL Purchase Order #Q8503326-00-SV and in a letter from Piteau Associates Engineering Ltd. (PAEL) to Mr. J. Hendry of QCL on March 25, 1985. Studies were ongoing between February and April, 1985 and preliminary findings were discussed with QCL personnel at intermediate stages of the project. A draft summary report was prepared and transmitted to Mr. B. Wong of QCL on May 8, 1985. The draft report was reviewed by QCL personnel, subsequently finalized and submitted on May 25, 1985. The complete report forms Appendix Volume 3 of this report.

5.2 DESCRIPTION OF THE INVESTIGATION

A detailed program of geotechnical and hydrogeological data collection and evaluation was carried out to help characterize the rock mass and surficial soils in the vicinity of the proposed open pit and waste dump sites.

A general site reconnaissance was carried out and available bedrock outcrops were mapped for geologic structure. Mapping data were stereographically analyzed and discontinuity sets and spatial relationships were assessed. Diamond drill core from strategically located drillholes was geotechnically logged and photographed and bedding dips were recorded at regular intervals in the core. These data were assessed statistically and used in conjunction with existing information to evaluate discontinuity and rock mass characteristics and to aid in the overall geologic interpretation.

Sealed piezometers and open standpipes were installed in rotary drillholes to augment existing instrumentation. Falling head tests were carried out in all new and existing piezometer installations. Results were assessed in conjunction with existing information and estimates of the ranges of hydraulic conductivity and anisotropy of the rock mass were made. Water levels measured in piezometers and open drillholes and limited hydrogeological mapping were used to evaluate current groundwater conditions.

Steady-state, finite-element computer modelling was used to check the ranges of hydraulic conductivity and anisotropy estimated from field testing and to assess seepage inflows to the pit. Areas of potential groundwater problems were identified and possible remedial measures were suggested.

Analyses were carried out to determine the kinematically possible failure modes which could be expected on the various types of walls in the open pit. Detailed slope stability analyses were carried out and slope design criteria were established for all footwall slopes. Specific slope design recommendations were established for individual hanging wall and endwall slopes and general slope design recommendations applicable to all slopes were prepared. A separate assessment of the feasibility of establishing a haulroad within the southwest footwall slope was carried out and appropriate design criteria established.

Airphotos covering the prospective pit and waste dump sites were reviewed and an interpretation of the origin, possible types and distribution of surficial soils was prepared. A detailed reconnaissance of the main proposed waste dump sites was carried out and natural soil exposures were mapped. Samples of surficial soils obtained from air rotary drilling were examined and a program of test pitting and sampling of various soil strata was undertaken. Test pit logs were prepared and gradation and index property testing of representative samples was carried out. This information was used in conjunction with information available from other studies to

evaluate material characteristics and distribution within potential dump foundations. A detailed deep subsurface investigation of a portion of the South Dump site was recommended; however, this was deferred until a later stage. Field reconnaissance and test pitting in the vicinity of the Centre Dump site were not conducted for this study and have also been deferred to a later stage.

Based on the distribution of surficial sediments in the vicinity of the proposed waste dump sites, three basic dump foundation types were identified. Estimates of shear strength of the various soil strata were made, appropriate stability analyses were carried out and design guidelines were prepared for each foundation type. Based on these guidelines, recommendations were prepared for waste dump construction in the North and Alternate Dump sites and for the portion of the South Dump site not underlain by lacustrine silt. Preliminary design guidelines (subject to confirmation by further investigation and/or analyses) were prepared for the portion of the South Dump underlain by lacustrine silt and for the Centre Dump site.

5.3 ENGINEERING GEOLOGY

The Quintette area lies within the Peace River Coal Field of northeastern British Columbia and is characterized by broad synclines and anticlines separated by low to medium angle thrust faults which dip towards the southwest. The Shikano Project area, located immediately southwest of the plant site, is characterized by flat to moderately steep (i.e. about 30° to 35°) topography which is crossed by a number of drainage courses. Mill Creek presently crosses the proposed pit area and will be diverted towards the south along a bench on the southeast endwall located near the pit crest and around the South Dump into M9 Creek.

COMPLETED 1
LABORATORY ANALYSIS

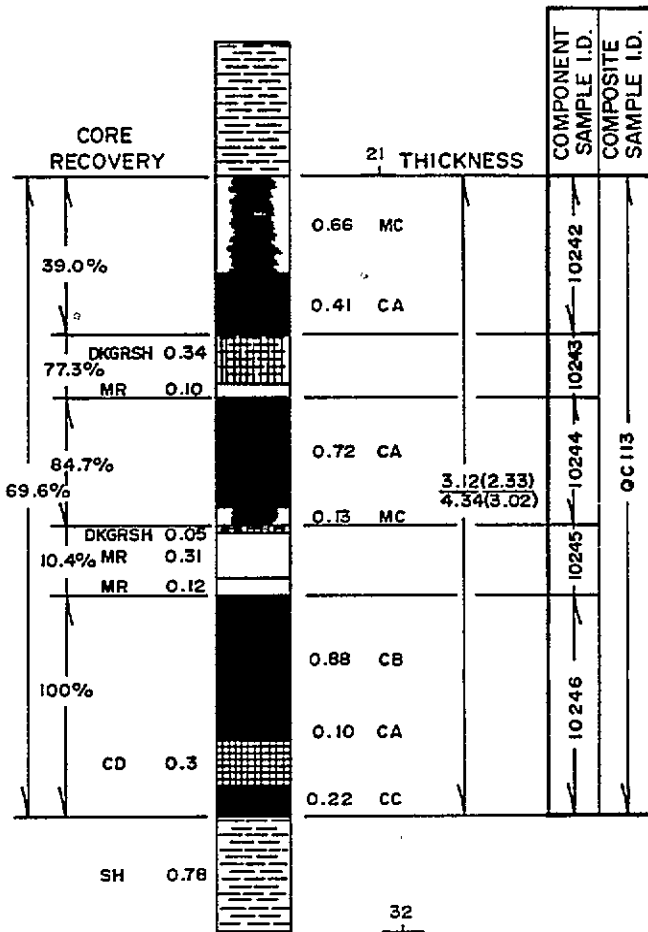

SAMPLE I.D.	FLOAT/SINK @ 1.50 SG (PROXIMATE) F.S.I.	RAW COMPOSITE WASHABILITY (SHORT)	CLEAN COMPOSITE	CLEAN ASH ANALYSIS	SLAGGING & FOULING	ASH FUSIBILITY	FLUIDITY	DILATATION	PETROGRAPHY
	10242								
10243									
10244		QC 113	QC 113	QC 113	—	—	QC 113	QC 113	—
10245									
10246									

RAW ANALYSIS

R.M.	ASH	V.M.	F.C.	F.S.I.	S
0.78	35.68	15.52	48.02	4.0	0.47

COMMENTS:

RECOVERED (m) : 3.02
MISSING COAL (m) : 0.79
MISSING ROCK (m) : 0.53

Date: 24/03/85	QUINTETTE COAL LIMITED	QBD8213
Design: KTJ	Project Manager DENISON MINES LIMITED	G SEAM
Drawn: KJV		SAMPLE DETAILS
Scale: 1:50 (VERT.)	COAL DIVISION	Drawing No. 85- Rev. 0

BCIL 7742 OCL

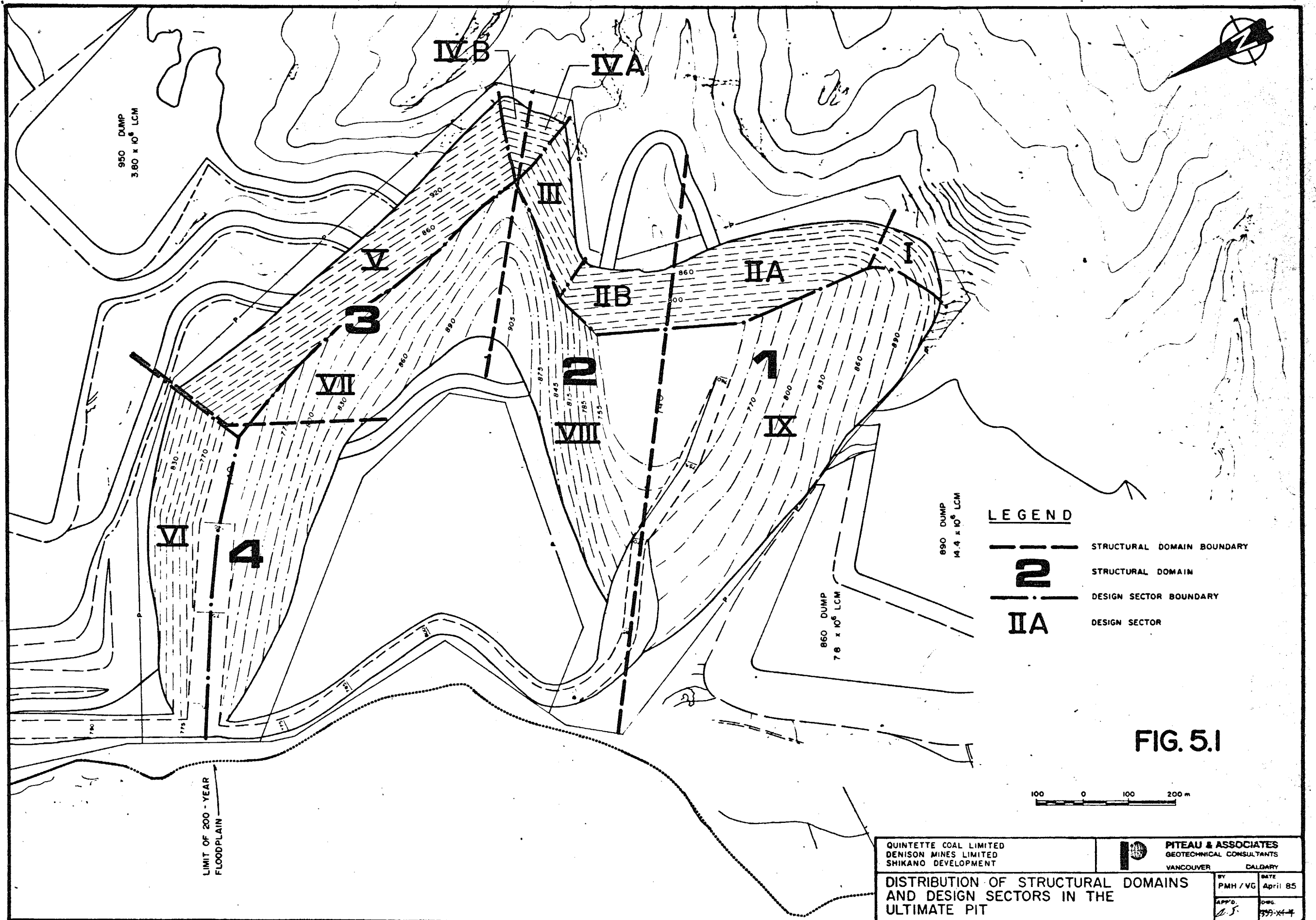



FIG. 5.1

QUINTETTE COAL LIMITED DENISON MINES LIMITED SHIKANO DEVELOPMENT		 PITEAU & ASSOCIATES GEOTECHNICAL CONSULTANTS VANCOUVER CALGARY	
DISTRIBUTION OF STRUCTURAL DOMAINS AND DESIGN SECTORS IN THE ULTIMATE PIT		BY PMH / VG	DATE April 85
APP'D. 		Dwg. 559-X-4	

the fixed relationship known to exist between bedding and the various joint sets.

Bedding joints are expected to be relatively continuous with spacings varying from about 0.1m, in closely bedded carbonaceous shales and siltstones, to greater than 4m for more massive sandstones and conglomerates. Shear strength along bedding joints is assumed to be purely frictional with friction angles ranging from 26° for carbonaceous bedding joints to about 34° for clean bedding joints in competent sandstone rocks. Cross joints, however, are expected to be relatively discontinuous, being commonly truncated or offset by throughgoing bedding joints. Cross joints, which tend to be slightly rougher than bedding joints, are assumed to have friction angles of about 35° and negligible cohesion.

On the basis of stratigraphy and general rock competency, as demonstrated by the rock mechanics properties recorded from drill core, the rock mass may be subdivided into four basic units. **Hanging Wall Rocks** are interbedded shales, siltstones, sandstones and conglomerates stratigraphically above D Seam and are of moderate to relatively good quality. **Interseam Rocks** are interbedded coals and commonly carbonaceous shales to sandstones and conglomerates between D and K Seams, inclusive, and are of relatively poor to moderate quality. **Immediate Footwall Rocks** are interbedded carbonaceous shales, siltstones and sandstones with occasional coal splits, generally occurring within a five metre stratigraphic depth below K Seam, and are of moderate quality. **Competent Footwall Rocks** are generally fine sandstones and siltstones which occur beneath the Immediate Footwall Rocks and are of relatively good quality. Based on the observed rock mechanics properties of core in each of these units, estimates of rock mass strength were prepared for use in subsequent stability analyses.

Results of the airphoto interpretation and the field and laboratory investigations indicate that a relatively thin blanket of loose to dense

fluvioglacial silt to gravel overlies a thin, well graded glacial till deposit, or rests directly on bedrock, in the vicinity of the North and Alternate Dump sites. Lenses of silt to gravel may also be present within the till which is generally very stiff but tends to be softer near the ground surface, particularly in areas of standing water. Similar formation conditions are also assumed to exist in the vicinity of the Centre Dump site; however, this assumption should be verified before finalizing dumping plans for this area.

Surficial geology of the South Dump site is somewhat more complex, consisting of at least six distinct deposits including colluvium, fluvial sand and gravel, lacustrine silt, glacial till, peat and alluvium. The silt deposit, which fills a depression in the central part of the site and may be as much as 35m to 45m thick, may be of particular importance to dump design. In this regard, additional investigations to confirm the areal extent, thickness and in situ strength characteristics of this deposit are necessary before a final dump design can be prepared for this area.

5.4 HYDROGEOLOGY

Groundwater flow systems in the Shikano area are expected to be local in extent, generally being isolated from regional flow systems by a thick sequence of Moosebar and Gething shales. Local flow systems tend to be shallow, reflecting stratigraphic control.

The catchment area for the proposed open pit is characterized by high relief and an estimated precipitation of 800 mm/yr. Recharge to groundwater via infiltration is expected to be about 15% of the annual precipitation. Colluvium and till, generally less than about 3m thick, cover the bulk of the pit catchment area. An upper bound estimate of groundwater flow through the surficial sediments into the proposed pit is about 8 lps.

Because of the bedded structure of the rocks in the vicinity of the Shikano Pit, the hydraulic conductivity of the rock mass is expected to be highly anisotropic, with the preferred groundwater flow direction parallel to bedding. In addition, the hydraulic conductivity of the rock mass is expected to be variable as a result of the variable lithology and natural fracture intensity. Based primarily on the results of falling head tests, the hydraulic conductivity of the rock mass parallel to bedding is expected to range between 5×10^{-8} m/s and 10^{-6} m/s. Anisotropy (i.e. the ratio of hydraulic conductivity parallel to bedding to hydraulic conductivity normal to bedding) is expected to range between 10 and 30. Water levels measured in sealed piezometers, open standpipes and open drillholes generally indicate the presence of strong downward (i.e. recharge) gradients across bedding, confirming the dominant geologic structural control and high anisotropy.

Steady-state, finite-element computer modelling was used to analyze both existing and post-mining groundwater flows and to predict the probable range of groundwater conditions in the proposed open pit. Initially, the pre-mining condition was modelled to determine if the estimated ranges of hydraulic conductivity and anisotropy were reasonable. Results of this modelling indicate the rock mass hydraulic conductivity is about 10^{-7} m/s with an anisotropy of greater than 10, both of which are consistent with estimated values.

Following the initial pre-mining modelling, predictive modelling was carried out to assess potential groundwater inflows to the pit, water table positions and groundwater conditions in the pit walls. On the basis of modelling results, negligible inflows to the pit from the Murray River are expected. Steady-state inflows to the pit from various pit walls are estimated to be 19 lps. In addition, a transient inflow of 51 lps, due to release of groundwater from storage (primarily during the final year of mining) must be included, as well as the estimated 8 lps inflow from sur-

ficials. Hence, the total estimated groundwater inflow is 78 lps in the last year of mining. During the early phases of mining, groundwater inflows would be considerably less than this value. Because of the number and character of assumptions involved in these estimates, a range of $\pm 30\%$ should be allowed for in assessing sump and pumping requirements and in the design of settling ponds which would receive this water.

Modelling results also indicate that all slopes should be moderately drained and should not require any remedial dewatering. However, two conditions not considered by the modelling could adversely affect groundwater conditions behind certain slopes. Significant groundwater recharge to the southeast wall could result from leakage of the M11 Diversion channel or from groundwater flow in surficial sediments not intercepted by the diversion structure. In this regard, the M11 Diversion structure and diversion channel should be designed to limit leakage. Piezometric pressures in the southeast wall should also be monitored using existing and additional piezometer installations.

Natural groundwater flow from Babcock Mountain towards the Murray River could result in higher recharge to the northeast and southwest slopes than was considered in the modelling. Effects of this additional recharge on the northeast wall would be minimal because the strata are favourably oriented to promote natural drainage. The southwest wall, however, is a footwall slope excavated essentially parallel to bedding and may not drain naturally, resulting in potentially higher piezometric pressures in the slope. Alleviation of these pressures may require artificial depressurization, possibly in the form of short, vertical relief wells installed at intervals as the slope is excavated. This may be particularly important in the event that bedding is undercut to establish a permanent haulroad on this slope. In any case, natural depressurization of this wall should be monitored during the early stages of mining to establish the level of remedial depressurization required. Additional piezometer installations are required to provide sufficient monitoring information. -

In addition to the above recommended monitoring, all existing piezometers should be monitored on a monthly basis starting from the present and continuing until they are destroyed by mining or mining is completed. Every effort should be made to preserve piezometer installations in drillholes QBD8205 and QSR85001. Monitoring will provide baseline hydrogeologic data and will allow an assessment of the groundwater conditions behind the pit walls during mining. If monitoring data indicates that additional depressurization is required to ensure stability of the slopes, appropriate depressurization measures could be implemented.

5.5 SLOPE STABILITY ANALYSES AND DESIGN

Based on the location of structural domains and the orientations of proposed slopes, the ultimate pit was divided into eleven Design Sectors, within which both the structural geology and general slope orientation are expected to be relatively constant (see Fig. 5.1). On the basis of these eleven design sectors, the proposed slopes may be subdivided into two basically different slope types: footwall slopes, which are excavated parallel or subparallel to bedding; and hanging wall or endwall slopes, which are excavated oblique or normal to the strike of bedding. Each of these slopes requires a fundamentally different stability analysis and slope design approach, as discussed in the following.

5.5.1 FOOTWALL SLOPES (DESIGN SECTORS VII, VIII AND IX)

Based on the current geologic interpretation, footwall slope stability is expected to be controlled by one of two basic modes of failure. Wherever bedding is to be undercut on a footwall slope, plane failure along bedding joints may control slope stability. Wherever the slope is excavated parallel to bedding, and bedding is sufficiently steep, bilinear slab failure, involving sliding along bedding joints combined with shearing through the rock mass in the toe of the slope, may control stability.

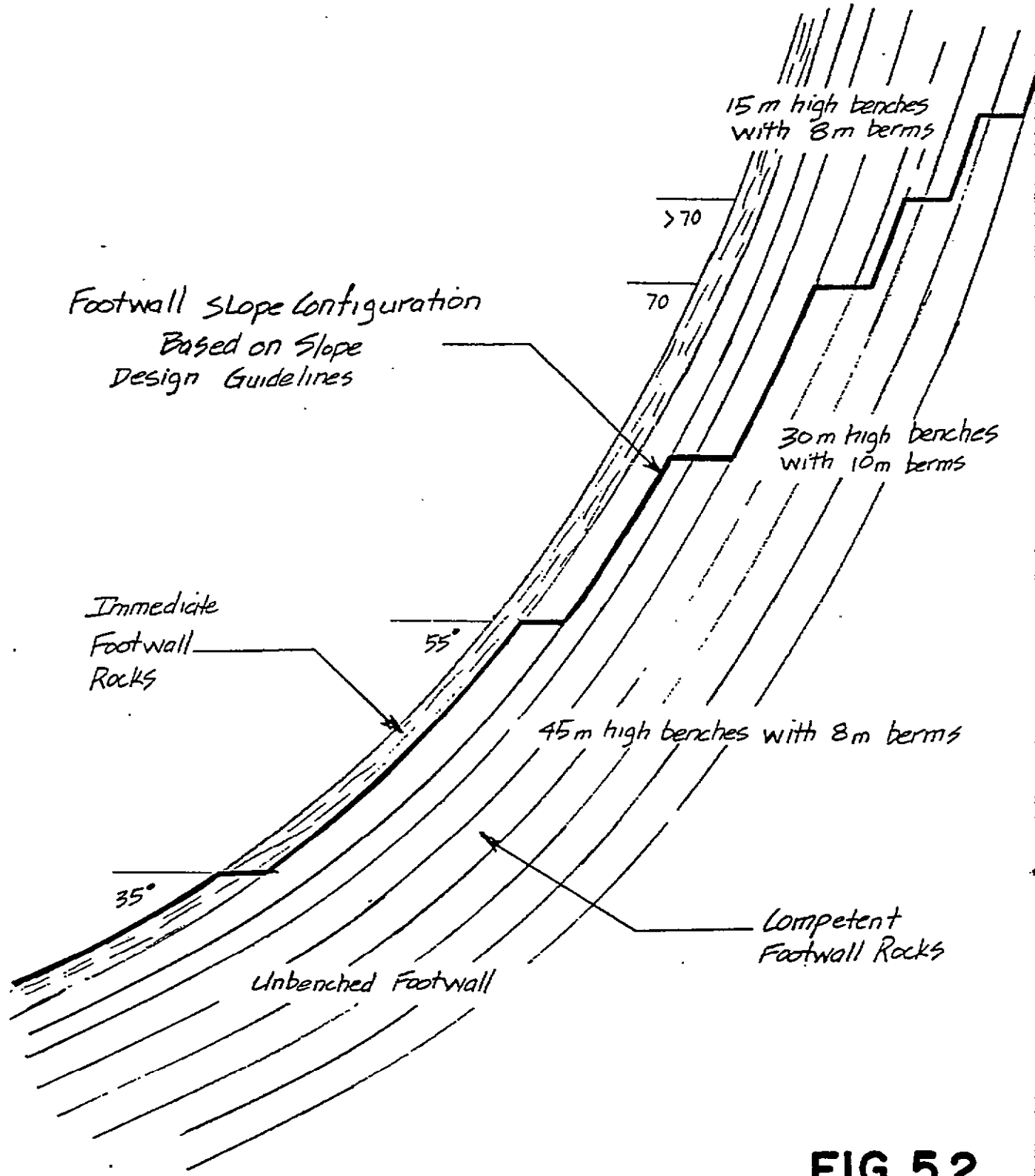

FIG. 5.2

QUINETTE COAL LIMITED
 DENISON MINES LIMITED
 SHIKANO DEVELOPMENT



PITEAU & ASSOCIATES
 GEOTECHNICAL CONSULTANTS
 VANCOUVER CALGARY

SCHEMATIC OF TYPICAL FOOTWALL SLOPE CONFIGURATION
 BASED ON FOOTWALL SLOPE DESIGN GUIDELINES

BY:	DATE:
PMH	APR 85
APPROVED:	DWG:
<i>I. S.</i>	359-X4-24

result, the number of unique endwall and hanging wall slope designs reduces to three as summarized in Table 5.1. The various design parameters given in Table 5.1 are illustrated and defined in Fig. 5.3.

5.5.3 GENERAL SLOPE DESIGN GUIDELINES

In addition to recommendations concerning specific walls or wall types, the following are general recommendations which are applicable to all slopes.

- Design of final slopes must include zones of transition between design sectors. In general, recommended maximum intermediate slopes should not be exceeded within transition zones; however, it may be feasible to steepen slopes in these areas on a trial basis.
- Final wall blasts should be designed to minimize breakback of bench crest. In this regard, blasting trials should be carried out and evaluated to determine the optimum form of blast control. Ripping or other non-explosive excavation of coal next to final walls should be carried out whenever possible.
- Artificial support or rockfall protection measures may be required in some areas. Such measures could include rock bolting, dowels or mesh as required to protect critical installations or to stabilize unstable areas.
- All benches should be thoroughly scaled and berms kept reasonably clean of debris to maintain effective rockfall catchments.
- Existing and additional recommended piezometers should be monitored as the pit is developed. Results of monitoring will aid in determining the location, extent and optimum method of any required artificial groundwater depressurization.

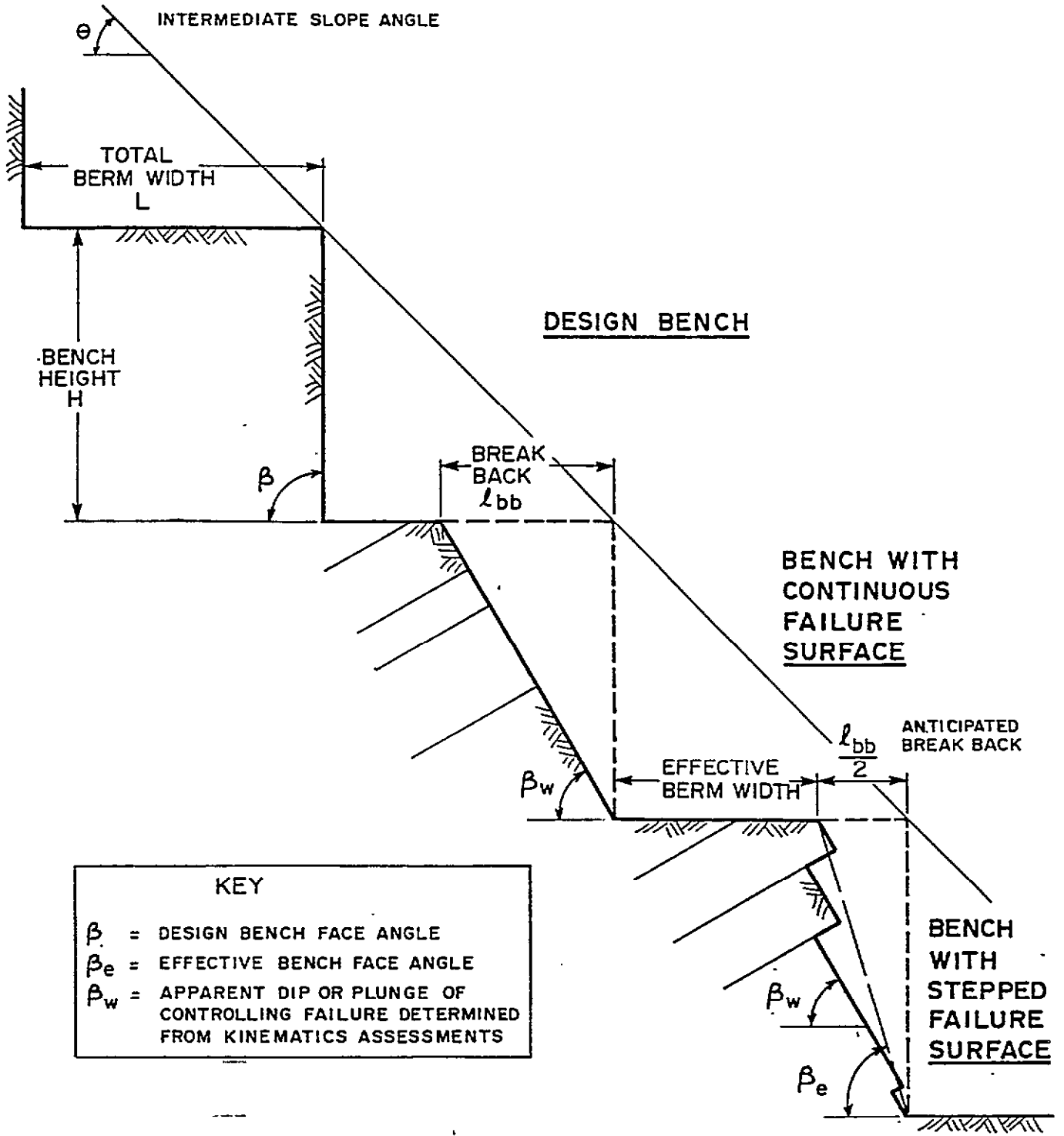

FIG. 5.3





<p>QUINETTE COAL LIMITED DENISON MINES LIMITED SHIKANU DEVELOPMENT</p>	<p> PITEAU & ASSOCIATES GEOTECHNICAL CONSULTANTS VANCOUVER CALGARY</p>				
<p>SLOPE GEOMETRY PARAMETERS</p>	<table border="1"> <tr> <td data-bbox="1201 1849 1347 1931"> <p>BY PMH</p> </td> <td data-bbox="1347 1849 1509 1931"> <p>DATE: APR 85</p> </td> </tr> <tr> <td data-bbox="1201 1931 1347 2013"> <p>APPROVED: </p> </td> <td data-bbox="1347 1931 1509 2013"> <p>DWG: 339-X4-25</p> </td> </tr> </table>	<p>BY PMH</p>	<p>DATE: APR 85</p>	<p>APPROVED: </p>	<p>DWG: 339-X4-25</p>
<p>BY PMH</p>	<p>DATE: APR 85</p>				
<p>APPROVED: </p>	<p>DWG: 339-X4-25</p>				

TABLE 5.1
SUMMARY OF RECOMMENDED SLOPE DESIGNS

DESIGN SECTOR	WALL TYPE	FAILURE MODE CONSIDERED FOR CONTROL, DESIGN STABILITY	MAXIMUM BEDDING DIP RANGE OF BEDDING DEFS (θ)	MAXIMUM SLOPE HEIGHT BETWEEN BERMS (m)	DESIGN BURCH FACE ANGLE (θ)	DESIGN BERM WIDTH (m)	ANTICIPATED BERM SLACK AT CREST (m)	EFFECTIVE BERM WIDTH (m)	EFFECTIVE BURCH FACE ANGLE (θ)	MAXIMUM INTERMEDIATE SLOPE ANGLE (θ)	COMMENTS									
VII VIII IX	FOOTBALLS (Immediate Football Rocks)	Bifurcate Slab Failure	30	15	70	8	0	8	70	48	-Designs apply to the first 5m stratigraphically beneath the base of X Stem -Design assumes bedding is undercut (slab failures may require local remedial measures)									
												Plane failure on bedding	35	Unbenched Slopes	Parallel to Bedding	-	-	-	35 (Parallel to Bedding)	
													40	75	Parallel to Bedding	8	0	8	Parallel to Bedding	38
													45	45	Parallel to Bedding	8	0	8	Parallel to Bedding	40
													55	30	Parallel to Bedding	10	0	10	Parallel to Bedding	51
													60	15	Parallel to Bedding	8	0	8	Parallel to Bedding	55
													90	15	90	8	0-2	6-8	30	-
												Blifurcate Slab Failure	45	Unbenched Slopes	Parallel to Bedding	-	-	-	45	
													55	45	Parallel to Bedding	8	0	8	Parallel to Bedding	49
													70	30	Parallel to Bedding	10	0	10	Parallel to Bedding	55
													80	15	Parallel to Bedding	8	0	8	Parallel to Bedding	55
													90	15	90	8	0-2	6-8	30	-
I	OBLOQUE ENDWALL	Stepped Hedge Failure	N/A	30 (Double Benches)	70	14.2	0 - 3.9	10.5-14.2	64-70	50	-Design Sector I may be subject to plane failures on bedding where 15 m or more between most footballs along the wall as may be required in this area.									
												IIA	ENDWALL	Stepped Plane Failure						
												IIB	ENDWALL	Stepped Plane Failure						
III	HANGING WALL	Stepped Hedge Failure or Stepped Plane Failure	N/A	30 (Double Benches)	90	29.0	15.0-18.4	10.5-14.0	59-63	46										
												IIIA	ENDWALL	Stepped Plane Failure						
												IIIB	ENDWALL	Stepped Plane Failure						
IV	ENDWALL	Stepped Plane Failure	N/A	30 (Double Benches)	90	29.0	15.0-18.4	10.5-14.0	59-63	46										
												IVB	ENDWALL	Stepped Plane Failure						
V	OBLOQUE HANGING WALL	Stepped Hedge Failure or Stepped Plane Failure	N/A	30 (Double Benches)	80	20.7	7.1- 9.9	10.6-13.6	63-66	49										
												VII	HANGING WALL	Stepped Plane Failure						

- NOTES: 1. Football slopes are assumed excavated parallel to the strike of bedding.
2. The occurrence of rolls and/or folds in bedding, high groundwater pressures or discrete unfavourably oriented faults or shears may require modifications to the designs shown. An ongoing programme of geotechnical and piezometric monitoring should be conducted to ascertain the location of any such occurrences so that the slope designs may be altered, and/or remedial measures applied, if required.
3. It is assumed that coal next to final footballs will be excavated by flipping or other non-explosive techniques, and that controlled blasting will be utilized in the excavation of all other final walls.
4. Final slopes and trial bluffs should be evaluated and updated by slope designs, as required.
5. Recommended slope designs are based on results of kinematic assessments, operational considerations and observed behaviour of existing slopes excavated in similar rock masses in the vicinity of the mine and slantments.
6. Design sectors are shown in Fig. 4.
7. Slope degradation may be required in some areas as described in Section 4.

- In-pit sumps or graded drainage ditches should be used to control precipitation and runoff within the pit.
- Trial slopes, consisting of higher benches, steeper bench face angles, and/or narrower berms than those recommended, should be incorporated into the slope on a trial basis, with due consideration given to operational constraints and ramifications of unsuccessful trials. Such trials are useful for verifying final slope designs.
- Monitoring hubs (survey control points) should be established on selected benches on all major slopes. In addition, periodic visual inspections of all slopes should be carried out. If slope movements are detected, monitoring frequency should be increased and the type of movement determined to aid in the design of remedial measures, if required.
- All slopes should be mapped and documented during excavation. The information should be used to update the geologic data base and reassess slope designs on an ongoing basis. Particular attention should be placed on identifying major faults, bedding rolls or other unfavourably oriented structures which could significantly affect overall slope stability.
- Although avalanches are not expected to be a serious concern, the potential for snow and avalanche problems should be assessed.

5.5.4 SOUTHWEST FOOTWALL RAMP

Construction of a proposed ramp on the southwest footwall slope would require undercutting bedding along its entire length. Based on the anticipated range of bedding dips expected along this area, the proposed ramp appears feasible, provided certain precautions and possible remedial measures are taken, as follows:

- Where bedding dips less than 20° , the haulroad cut may be excavated using a single bench inclined at about 60° as indicated in Fig. 5.4
- Where bedding dips between 20° and 25° , an excavated slope utilizing an intermediate bench, as indicated in Fig. 5.4, is recommended. In addition, to prevent occasional small plane failures involving undercut Intermediate Footwall Rocks, one or two rows of dowels installed along the crest, as shown in Fig. 5.4, may be required. If required, these dowels should be installed prior to excavation of the cut.
- In all cases, a ditch should be incorporated to trap material rolling off undercut slopes.
- Carefully controlled blasting techniques should be utilized to minimize damage to the final cut face and footwall slope.
- Groundwater pressures should not be permitted to develop in near surface strata along the undercut section. In this regard, short, vertical relief holes may be required.
- Regular survey and visual monitoring of undercut slopes is recommended wherever bedding dips in excess of 20° . Monitoring should also be carried out during and/or following significant events such as blasts, substantial rainfall, spring thaw, etc.

Artificial depressurization and support requirements and designs can best be determined during the initial stage of excavation, once some first-hand experience with slope behaviour has been gained.

JOB NUMBER

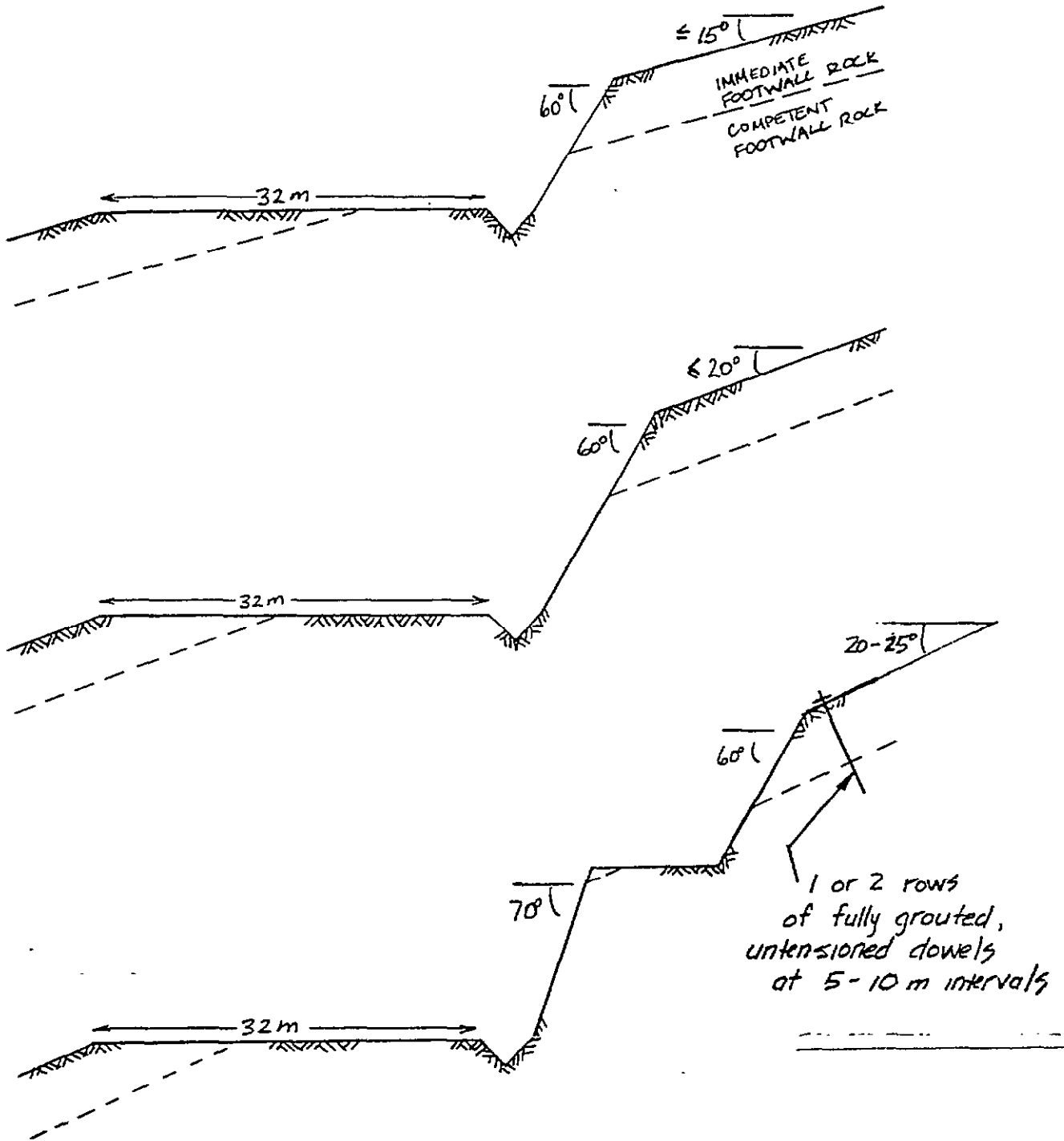

FIG. 5.4

QUINETTE COAL LIMITED
DENISON MINES LIMITED
SHIKANO DEVELOPMENT



PITEAU & ASSOCIATES
GEOTECHNICAL CONSULTANTS
VANCOUVER CALGARY

RECOMMENDED S.W. FOOTWALL RAMP DESIGN

BY: BST	DATE: MAY 85
APPROVED: MA	DWG: 599-XA-26

5.6 WASTE DUMP STABILITY ANALYSIS AND DESIGN

In addition to bedrock outcrops, at least six distinct soil deposits are exposed within the proposed waste dump sites (see Fig. 5.5). However, results of field and laboratory studies indicate that several of these deposits will behave similarly under proposed foundation loading conditions and, hence, may be considered together for purposes of analysis and design. Based on these assumptions, three basic foundation types were identified. Estimates of material shear strength and groundwater conditions were made and appropriate stability analyses were carried out for each foundation type.

Foundations composed of bedrock and mixed grained soils containing less than about 10% fines were considered as one foundation type. These may include coarse grained fluvioglacial and colluvial deposits. Such materials are expected to provide competent dump foundations and stability analyses indicate no limitations, other than routine performance monitoring, need be imposed on lift or dump height, given the maximum dump heights proposed.

Foundations composed of soils containing a mixture of fine and coarse sizes, including significant proportions of clay and silt, were considered as another foundation type. These include glacial till and some fluvial glacial and colluvial deposits, all of which may be relatively soft within the first few metres below ground surface. Stability analyses indicate that, based on assumed strengths and for a minimum Factor of Safety of 1.3, the maximum initial lift height is 22m. To maintain this factor of safety, a second lift of maximum 29m height would require a minimum setback of 40m between the toe of Lift 2 and the crest of Lift 1, corresponding to an overall slope angle of about 26° (see Fig. 5.6).

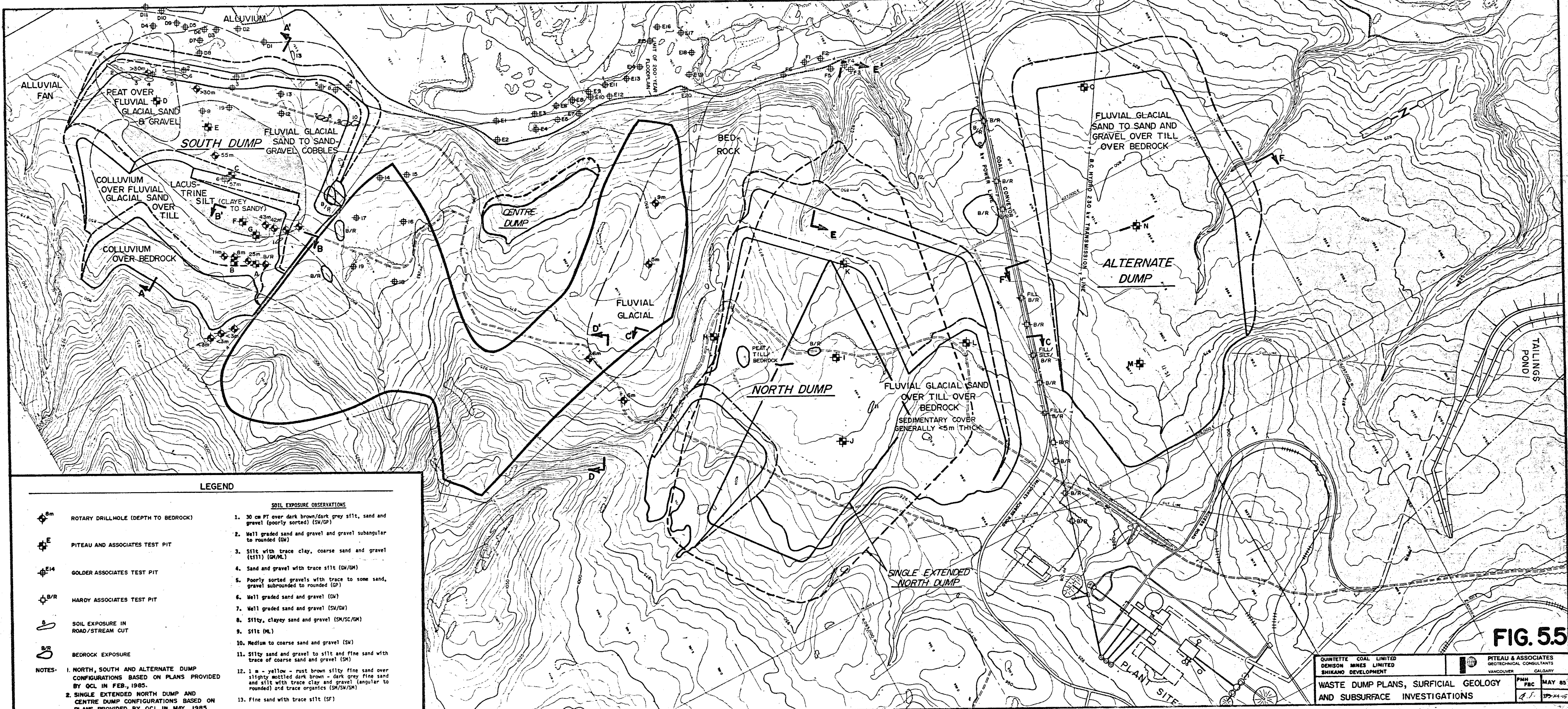

LEGEND

- ROTARY DRILLHOLE (DEPTH TO BEDROCK)
- PITEAU AND ASSOCIATES TEST PIT
- GOLDER ASSOCIATES TEST PIT
- HARDY ASSOCIATES TEST PIT
- SOIL EXPOSURE IN ROAD/STREAM CUT
- BEDROCK EXPOSURE

- SOIL EXPOSURE OBSERVATIONS**
1. 30 cm PT over dark brown/dark grey silt, sand and gravel (poorly sorted) (SM/GP)
 2. Well graded sand and gravel and gravel subangular to rounded (GW)
 3. Silt with trace clay, coarse sand and gravel (silt) (GM/ML)
 4. Sand and gravel with trace silt (GW/GM)
 5. Poorly sorted gravels with trace to some sand, gravel subrounded to rounded (GP)
 6. Well graded sand and gravel (GW)
 7. Well graded sand and gravel (SM/GM)
 8. Silty, clayey sand and gravel (SM/SC/GM)
 9. Silt (ML)
 10. Medium to coarse sand and gravel (SM)
 11. Silty sand and gravel to silt and fine sand with trace of coarse sand and gravel (SM)
 12. 1 m - yellow - rust brown silty fine sand over slightly mottled dark brown - dark grey fine sand and silt with trace clay and gravel (angular to rounded) and trace organics (SM/SW/SM)
 13. Fine sand with trace silt (SF)

NOTES:
 1. NORTH, SOUTH AND ALTERNATE DUMP CONFIGURATIONS BASED ON PLANS PROVIDED BY QCL IN FEB., 1985.
 2. SINGLE EXTENDED NORTH DUMP AND CENTRE DUMP CONFIGURATIONS BASED ON PLANS PROVIDED BY QCL IN MAY, 1985.

FIG. 55

QUINTETTE COAL LIMITED DENISON MINES LIMITED SHIKANO DEVELOPMENT	PITEAU & ASSOCIATES GEOTECHNICAL CONSULTANTS VANCOUVER CALGARY
WASTE DUMP PLANS, SURFICIAL GEOLOGY AND SUBSURFACE INVESTIGATIONS	
PMH FBC	MAY 85 37-24-15

The third foundation type consists of fine grained soils, specifically the stratified lacustrine silt and clay deposit contained within the South Dump site. Based on limited penetrometer testing of samples from shallow test pits, stability analyses were carried out assuming an undrained shear strength of 50 kPa for this material. Because this material is potentially 35m to 45m thick and sampling depth was limited to about 6m, it is possible that the minimum shear strength at depth is less than 50 kPa. Hence, analysis results and design recommendations must be considered preliminary, subject to additional deep, subsurface exploration to confirm the shear strength profile of this deposit. Based on these assumptions and analysis results, to maintain a minimum Factor of Safety of 1.3 while advancing the dump across this deposit, maximum lift thicknesses and minimum setbacks should be as indicated on Fig. 5.6.

Based on the distribution of the three basic foundation types and on the above lift height and setback restrictions, recommendations concerning waste dump construction in each of the proposed sites were prepared and are summarized as follows:

5.6.1 FOUNDATION PREPARATION

- Excessively soft material contained within wetland deposits should be excavated down to the level of competent till or colluvium. Peat deposits in excess of 150 mm thick should be removed.

5.6.2 NORTH AND ALTERNATE DUMPS

- The initial lift height should not exceed 22m and the second lift should not exceed 29m. Subsequent lifts, if required, should not exceed a thickness of 40m for the third lift and 55m for the fourth lift. Minimum setbacks should be maintained between the crest of the bottom lift and the toe of successive lifts, resulting in a maximum overall slope angle of 26°.

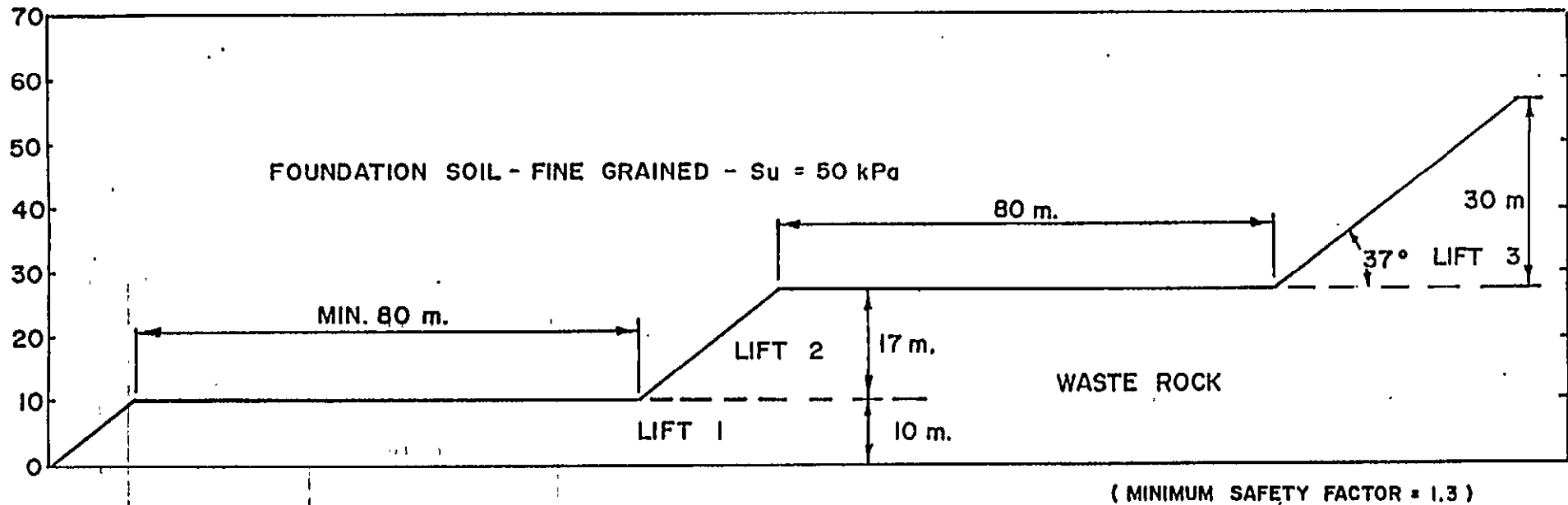
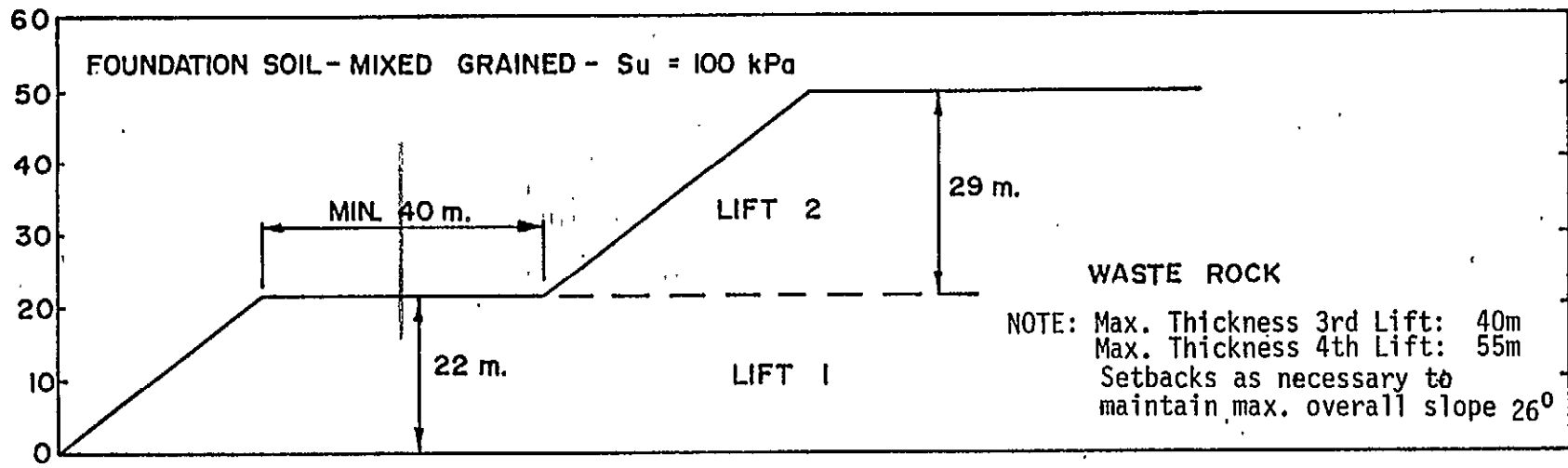

FIG. 5.6

QUINTETTE COAL LIMITED
DENISON MINES LIMITED
SHIKANO DEVELOPMENT



PITEAU & ASSOCIATES
GEOTECHNICAL CONSULTANTS
VANCOUVER CALGARY

MAXIMUM LIFT THICKNESS AND MINIMUM SETBACKS

FBC APR 85

E.S. 399-X1-28

5.6.3 CENTRE DUMP

- This dump should be constructed in two lifts to the maximum anticipated height of about 30m. The initial lift height should not exceed 22m and sufficient setback of the second lift should be such as to maintain an average overall slope of not more than 26° .

5.6.4 SOUTH DUMP

- Where dumps are founded on colluvium or bedrock (above approximate elevation 850m) no restrictions on lift height or setbacks need be observed.
- Where dumps are placed on fluvioglacial deposits (between approximate elevations 790m to 850m and below elevations 790m to 835m on Fig. 5.5), the same restrictions indicated above for the North and Alternate Dumps should be observed.
- Where dumps extend over the lacustrine silt deposit (between approximate elevations of 790m and 820m), initial lift thickness should not exceed 10m. The second lift should not exceed 17m and the third lift should not exceed 30m. Minimum setbacks of 80m should be maintained between lifts, corresponding to a maximum overall slope of 13.5° .

5.6.5 ADDITIONAL RECOMMENDATIONS

- A minimum setback of 30m should be maintained between dump toes and the pit crest or conveyor line.
- Dump performance should be monitored during construction. Deformation and pore pressure measurements, particularly within the lacustrine silt deposit in the South Dump site, will serve to confirm dump behaviour and to warn of impending instability.

- Additional subsurface investigations and laboratory testing should be carried out to better delineate the extent and shear strength characteristics of the lacustrine deposit in the South Dump site. Based on results of this investigation, additional analyses should be carried out to confirm preliminary dump design guidelines for this material or to modify them as required. In conjunction with this investigation, a limited number of drillholes located within the till deposit in the North Dump site are recommended to confirm strength and consolidation assumptions used in stability analyses.

- Appropriate field reconnaissance and test pitting in the vicinity of the Centre Dump site should be carried out prior to commencement of dumping to verify assumed foundation conditions.

Supplement 2.0

Geological Maps and Cross Sections

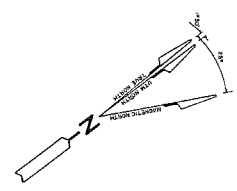

GEOLOGIC FORMATIONS

KS	SHAFFESBURY
KCB	BOULDER CREEK
KCH	HULCROSS
KCG	GATES
KM	MOOSEBAR

=====	SURVEYED ROAD
-----	UNSURVEYED ROAD
-----	COAL SEAM OUTCROP
-----	COAL SEAM SUBCROP
-----	GEOLOGIC CONTACT

↕	SYNCLINE
↕	ANTICLINE
↕	THRUST FAULT
↕	DIP & STRIKE
↕	ADIT
○	DRILL HOLE

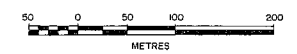

3	23/05/85	REVISED GEOLOGY & ORIENTATION	E J T		
2	17/04/85	UPDATED DRILL HOLE LOCATIONS	R L R	D M c	D M c
1	29/03/85	UPDATED D.H. LOCATIONS	K J V	D M c	D M c
D	12/02/85	ORIGINAL DRAFT	K J V	D J	D J
Rev.	D M V	Revision Description	Drn.	Des.	App.

QUINTETTE COAL LIMITED
 Project Manager
DENISON MINES LIMITED
 COAL DIVISION

Area SHIKANO Category GEOLOGY

Drawing Title
**SHIKANO
 GEOLOGY**

Scale Drawing No. Rev.

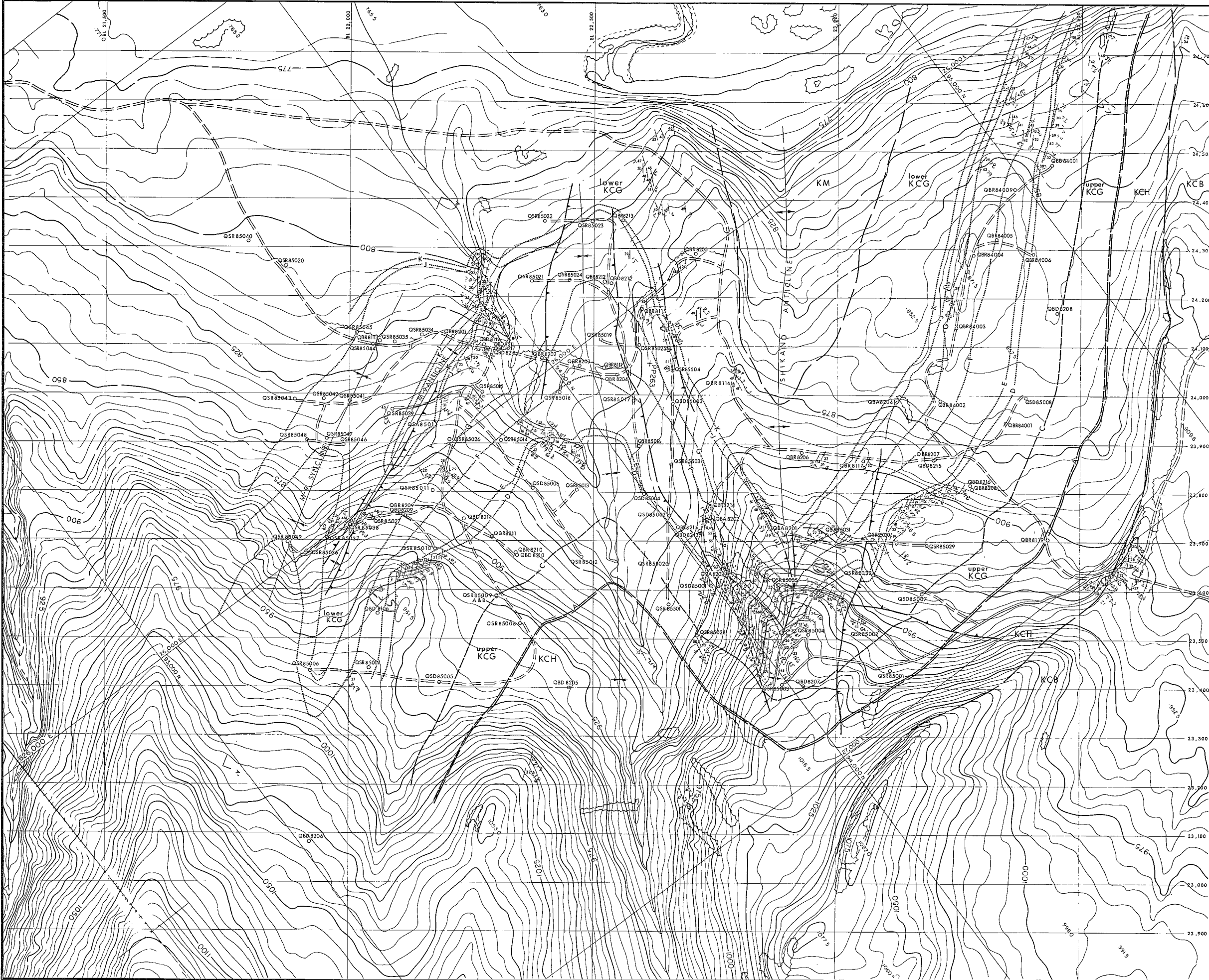

N.W.

S.E.

METRES ABOVE SEA LEVEL

23,000

A'

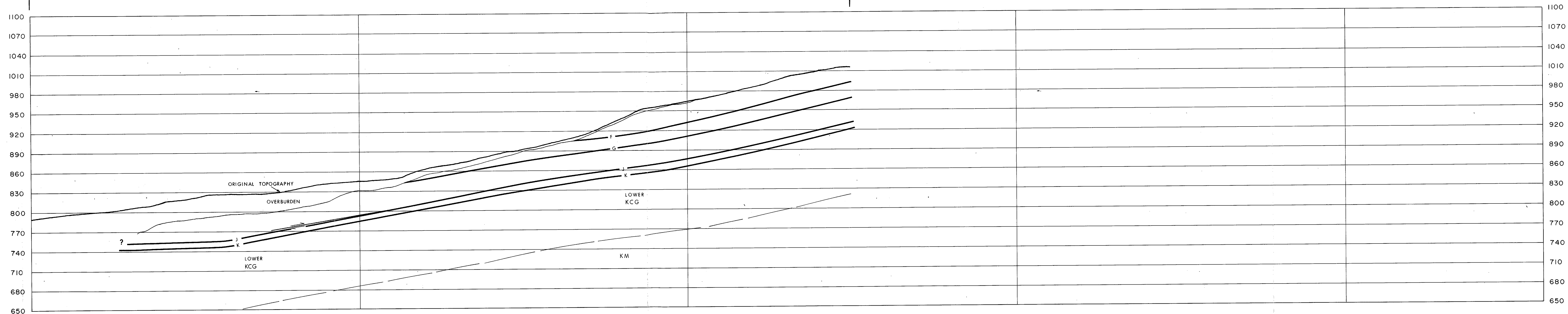

LEGEND

- DRILL HOLE LOCATION (SECTION)
- DRILL HOLE NUMBER
- DRILL HOLE
- BEDDING ANGLE IN CORE
- SEAM I.D., TOP OF SEAM
- PROJECTED APPARENT DIP IN SECTION OF OUTCROP
- TOP OF COAL SEAM
- FAULT WITH RELATIVE MOVEMENT
- FORMATION CONTACT

0	14	05	85	ORIGINAL DRAFT	KJV	GK	GK
Rev.	D	M	Y	Revision Description	Drn.	Des.	App.

QUINTETTE COAL LIMITED
 Project Manager
DENISON MINES LIMITED
 COAL DIVISION

Area SHIKANO Category CROSS SECTION

Drawing Title
SHIKANO
CROSS SECTION A-A'

Scale 1:2500	Drawing No. 85 - 300 - 21 - 022	Rev. 0
-----------------	------------------------------------	-----------

N.W.

S.E.

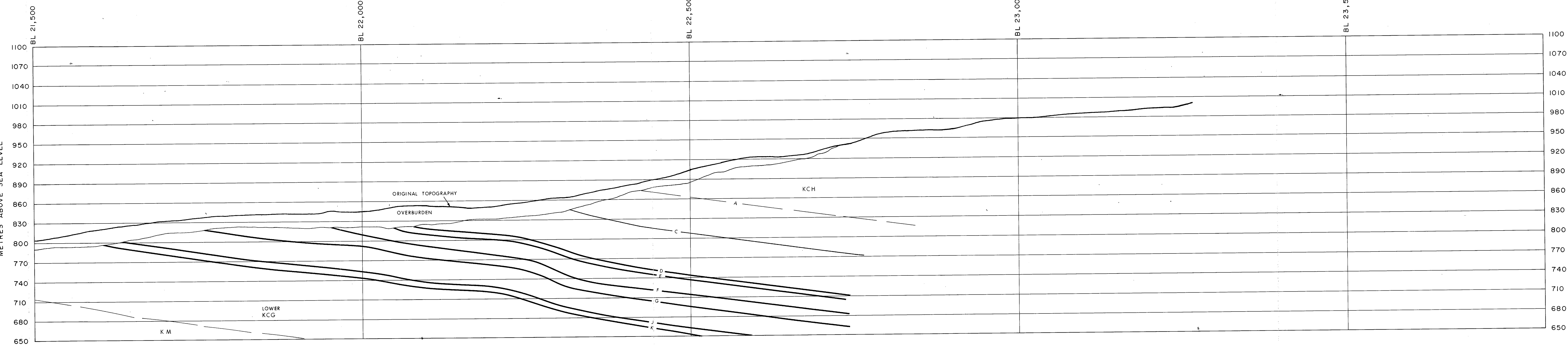

LEGEND

- DRILL HOLE LOCATION (SECTION)
- DRILL HOLE NUMBER
- DRILL HOLE
- BEDDING ANGLE IN CORE
- SEAM I.D., TOP OF SEAM
- PROJECTED APPARENT DIP IN SECTION OF OUTCROP
- TOP OF COAL SEAM
- FAULT WITH RELATIVE MOVEMENT
- FORMATION CONTACT

0	14	05	85	ORIGINAL DRAFT	KJV	GK	GK
Rev.	D	M	Y	Revision Description	Drn.	Des.	App.

QUINTETTE COAL LIMITED
 Project Manager
DENISON MINES LIMITED
 COAL DIVISION

Area SHIKANO Category CROSS SECTION

Drawing Title
SHIKANO
 LONGITUDINAL
 CROSS SECTION 22,500

Scale 1:2500	Drawing No. 85-300-21-021	Rev. 0
-----------------	------------------------------	-----------

S.W.

N.E.

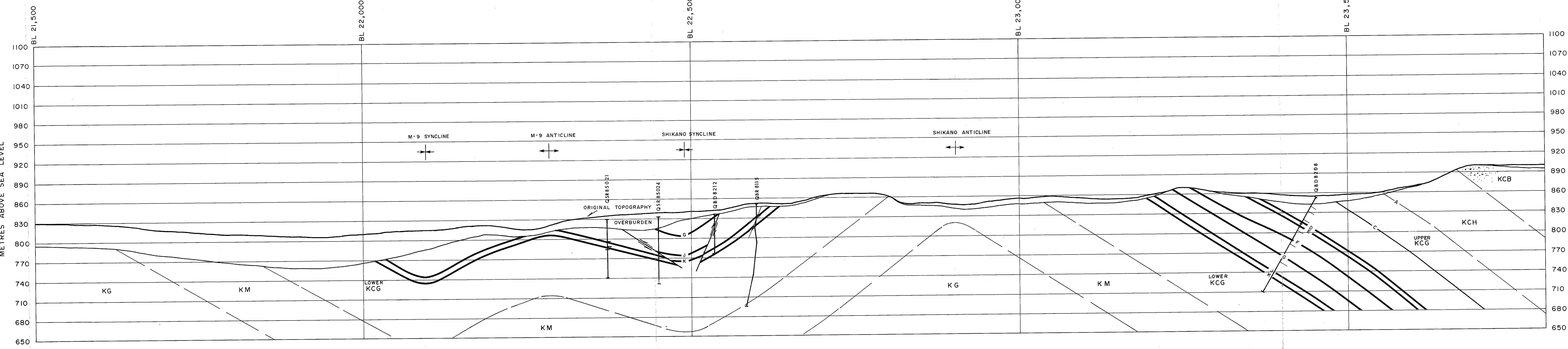

Legend:

- DRILL HOLE LOCATION (SECTION)
- DRILL HOLE NUMBER
- DRILL HOLE
- BEDDING ANGLE IN CORE
- SEAM I.D., TOP OF SEAM
- PROJECTED APPARENT DIP IN SECTION OF OUTCROP
- TOP OF COAL SEAM
- FAULT WITH RELATIVE MOVEMENT
- FORMATION CONTACT

Scale: 0 50 100 200 METRES

0	14	05	85	ORIGINAL DRAFT	KJV	GK	GK
Rev.	D	M	Y	Revision Description	Drn.	Des.	App.

QUINTETTE COAL LIMITED
 Project Manager
DENISON MINES LIMITED
 COAL DIVISION

Area SHIKANO Category CROSS SECTION

Drawing Title
SHIKANO
CROSS SECTION 24,200

Scale 1:2500	Drawing No. 85-300-21-015	Rev. 0
-----------------	------------------------------	-----------

S.W.

N.E.

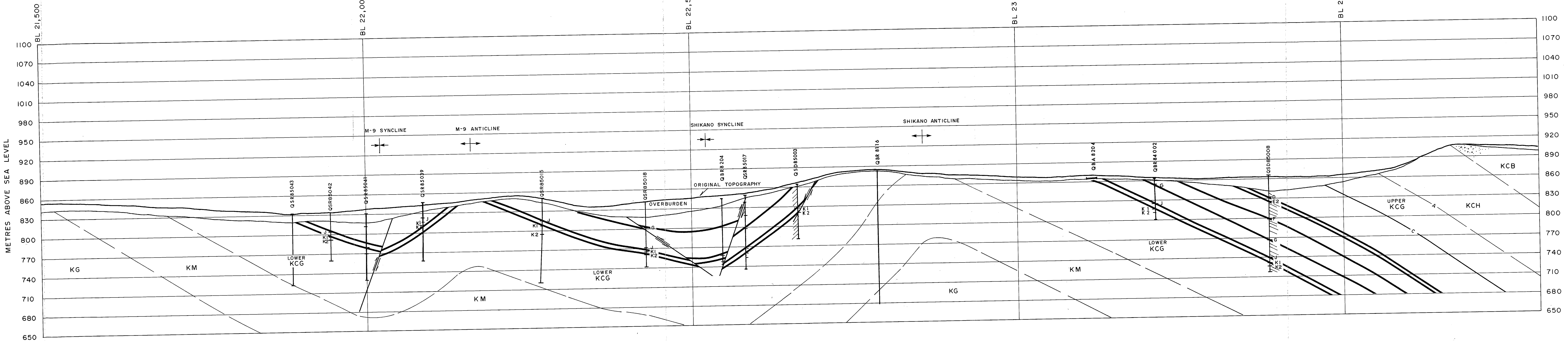

Legend:

- DRILL HOLE LOCATION (SECTION)
- DRILL HOLE NUMBER
- DRILL HOLE
- BEDDING ANGLE IN CORE
- SEAM I.D., TOP OF SEAM
- PROJECTED APPARENT DIP IN SECTION OF OUTCROP
- TOP OF COAL SEAM
- FAULT WITH RELATIVE MOVEMENT
- FORMATION CONTACT

Scale: 0 50 100 200 METRES

0	14	05	85	ORIGINAL DRAFT	KJV	GK	GK
Rev.	D	M	Y	Revision Description	Drn.	Des.	App.

QUINTETTE COAL LIMITED
 Project Manager
DENISON MINES LIMITED
 COAL DIVISION

Area SHIKANO Category CROSS SECTION

Drawing Title
SHIKANO
CROSS SECTION 24,000

Scale	Drawing No.	Rev.
1:2500	85-300-21-013	0

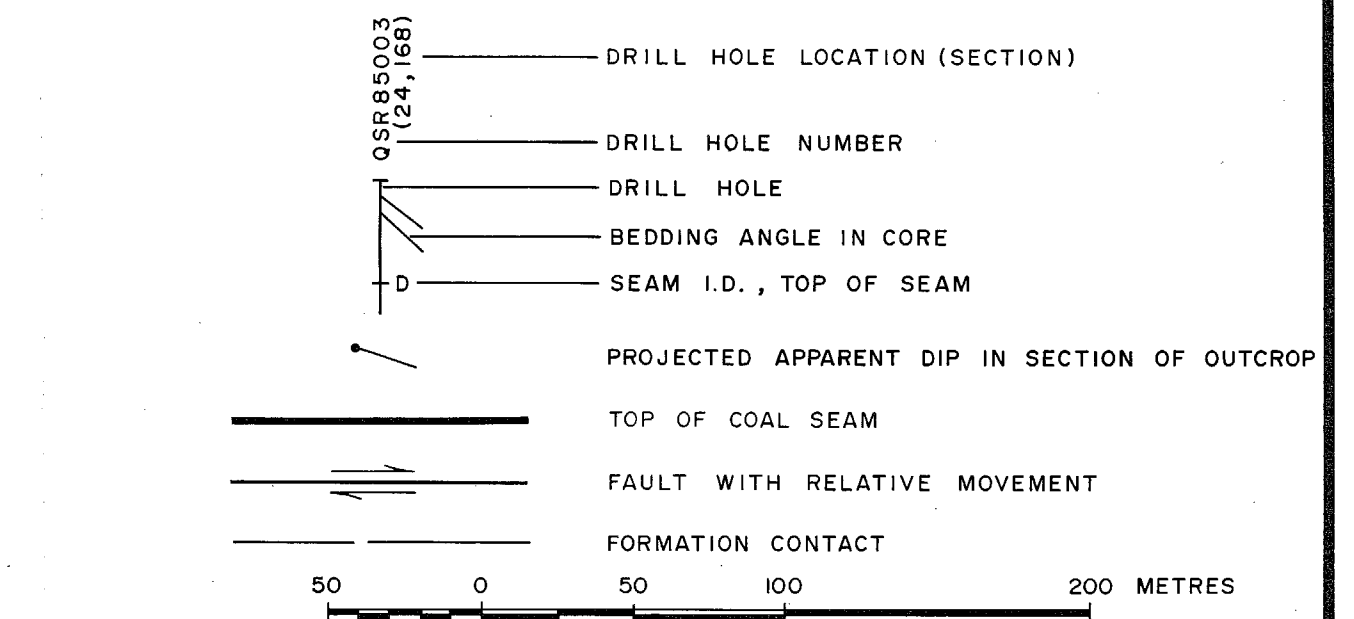
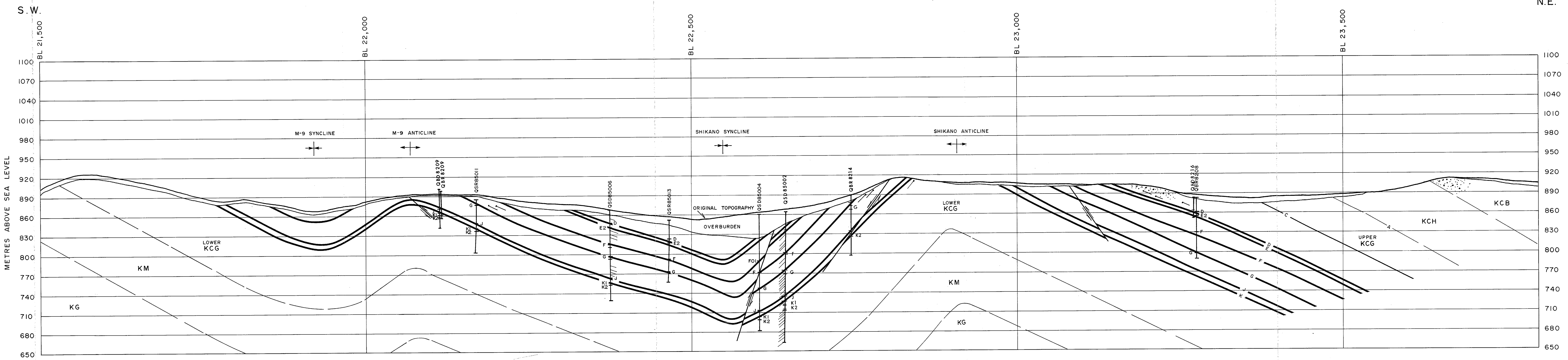

0	14	05	85	ORIGINAL DRAFT	KJV	GK	GK
Rev.	D	M	Y	Revision Description	Drn.	Des.	App.
QUINTETTE COAL LIMITED							
Project Manager							
DENISON MINES LIMITED							
COAL DIVISION							
Area SHIKANO				Category CROSS SECTION			
Drawing Title							
SHIKANO							
CROSS SECTION 23,800							
Scale		Drawing No.			Rev.		
1:2500		85-300-21-011			0		

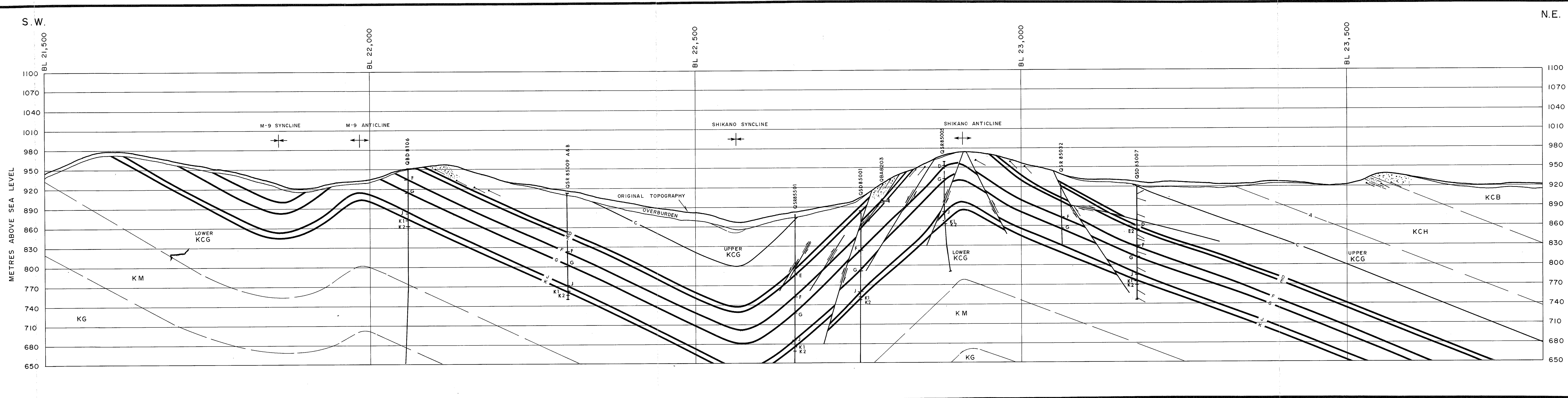

LEGEND

- DRILL HOLE LOCATION (SECTION)
- DRILL HOLE NUMBER
- DRILL HOLE
- BEDDING ANGLE IN CORE
- SEAM I.D., TOP OF SEAM
- PROJECTED APPARENT DIP IN SECTION OF OUTCROP
- TOP OF COAL SEAM
- FAULT WITH RELATIVE MOVEMENT
- FORMATION CONTACT

50 0 50 100 200 METRES

0	14	05	85	ORIGINAL DRAFT	KJV	GK	GK
Rev.	D	M	Y	Revision Description	Drn.	Des.	App.
QUINTETTE COAL LIMITED							
Project Manager							
DENISON MINES LIMITED							
COAL DIVISION							
Area SHIKANO				Category CROSS SECTION			
Drawing Title							
SHIKANO							
CROSS SECTION 23,600							
Scale		Drawing No.				Rev.	
1:2500		85-300-21-009				0	

Supplement 2.2.4

Coal Seam Correlation Charts

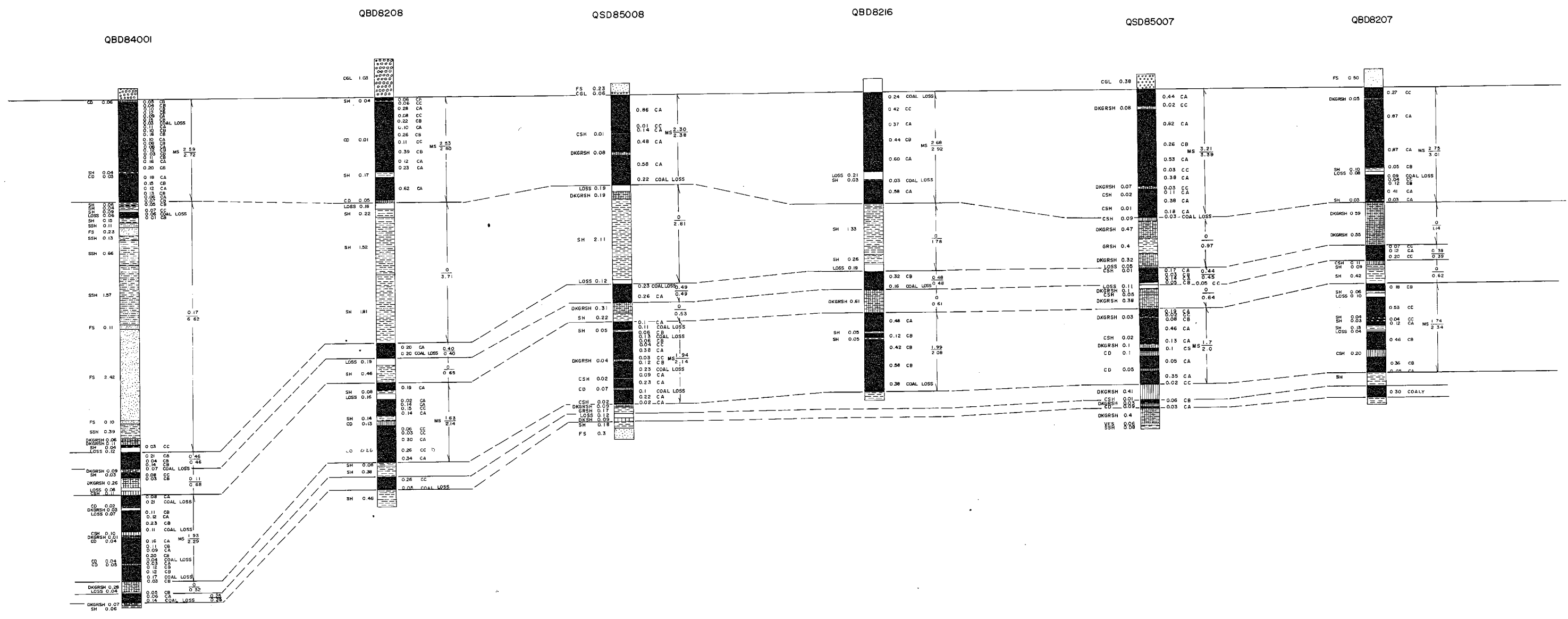

D SEAM

E SEAM

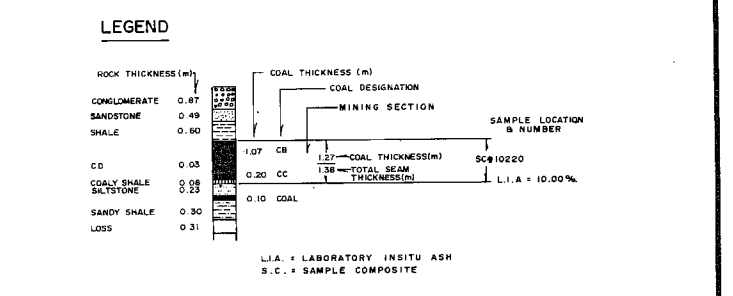
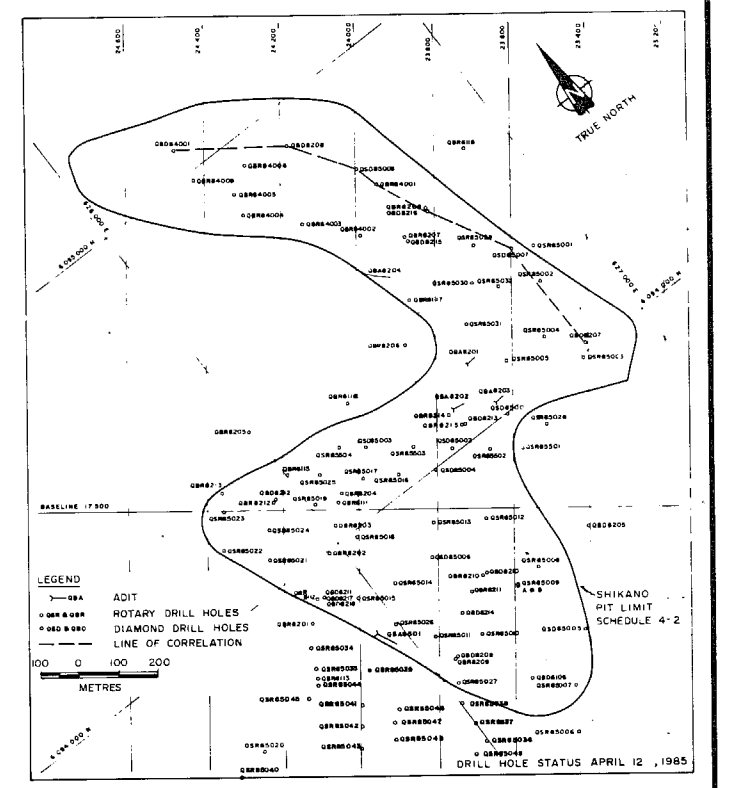

Rev.	D	M	Y	Revision Description	Drn.	Des.	App.

QUINTETTE COAL LIMITED
 Project Manager:
DENISON MINES LIMITED
 COAL DIVISION

Area: _____ Category: _____

Drawing Title:
D & E SEAMS
DETAILED SEAM CORRELATION

SHEET 1 OF 2

Scale: 1:50 (VERT.) Drawing No. 85-300-26-02 Rev. _____

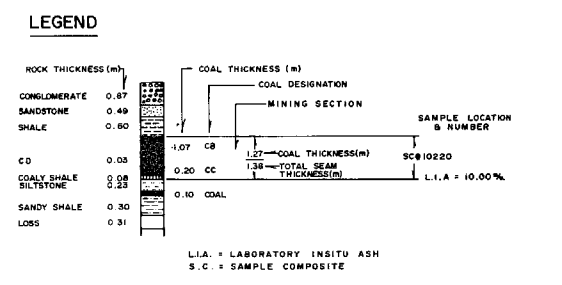
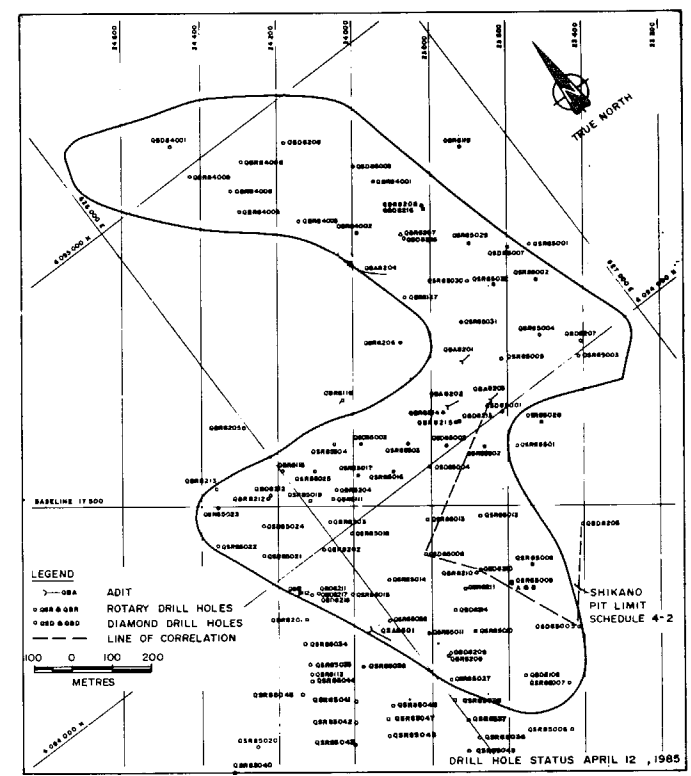
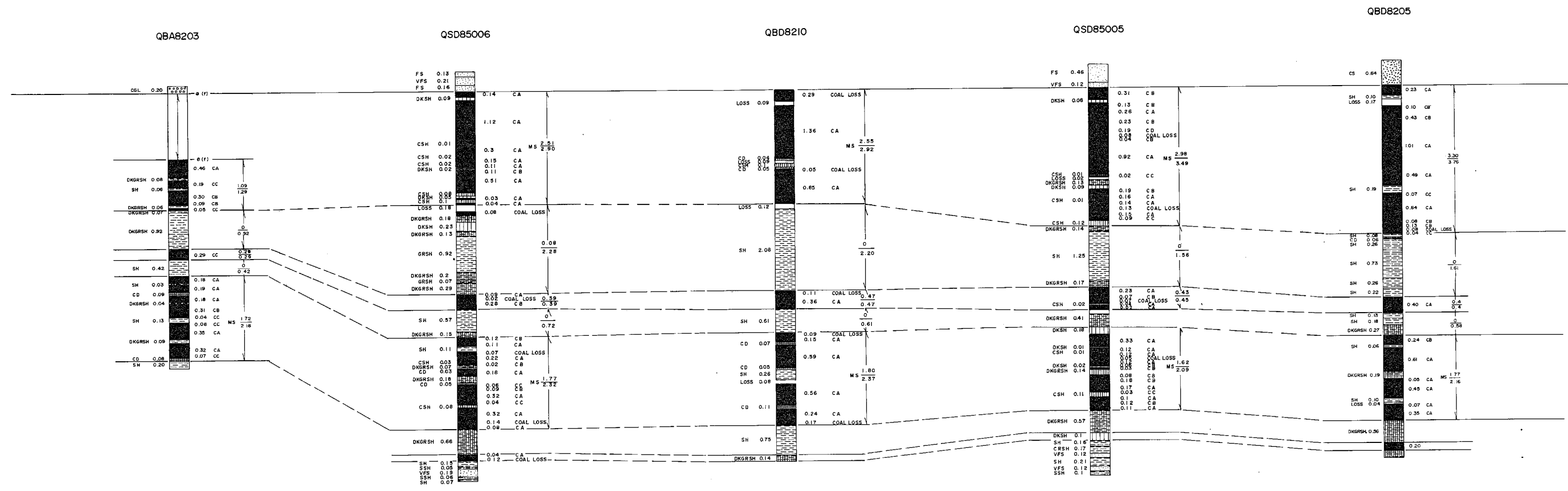

Rev.	D	M	Y	Revision Description	Drn.	Des.	App.

QUINTETTE COAL LIMITED
Project Manager
DENISON MINES LIMITED
COAL DIVISION

Area: _____ Category: _____

Drawing Title:
**D & E SEAMS
DETAILED SEAM CORRELATION**

SHEET 2 OF 2

Scale 1:50 (VERT.)	Drawing No. 85-300-26-02	Rev. 0
-----------------------	-----------------------------	-----------

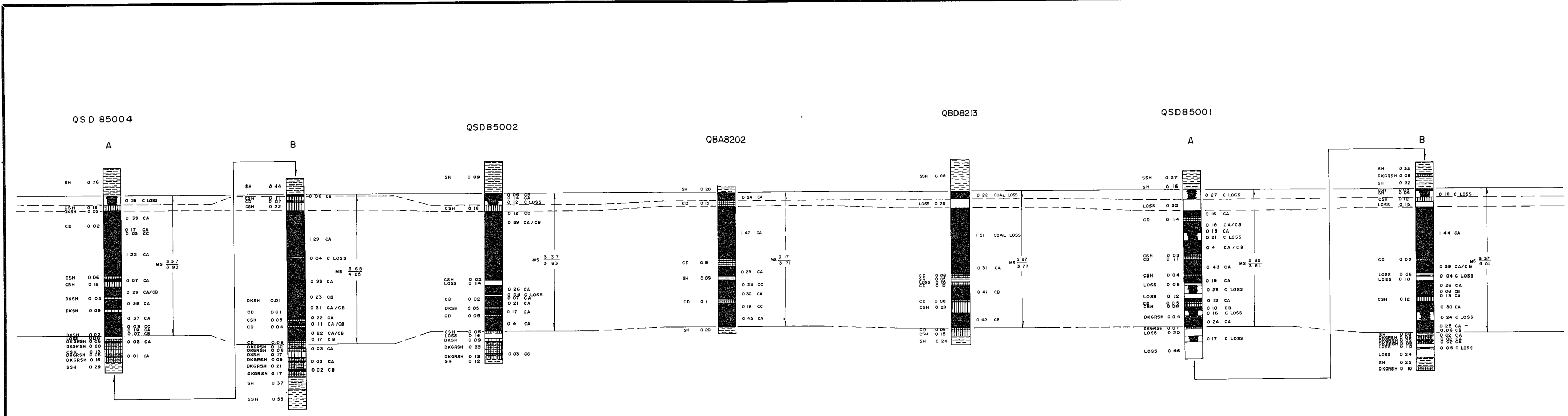

F SEAM

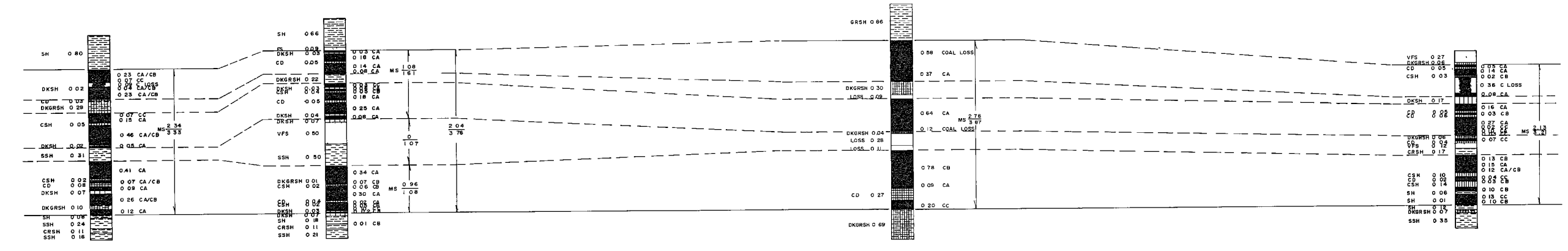
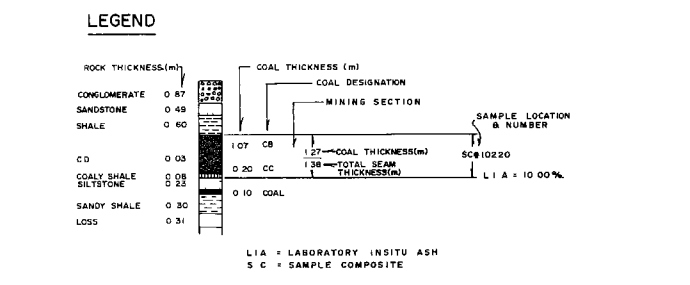
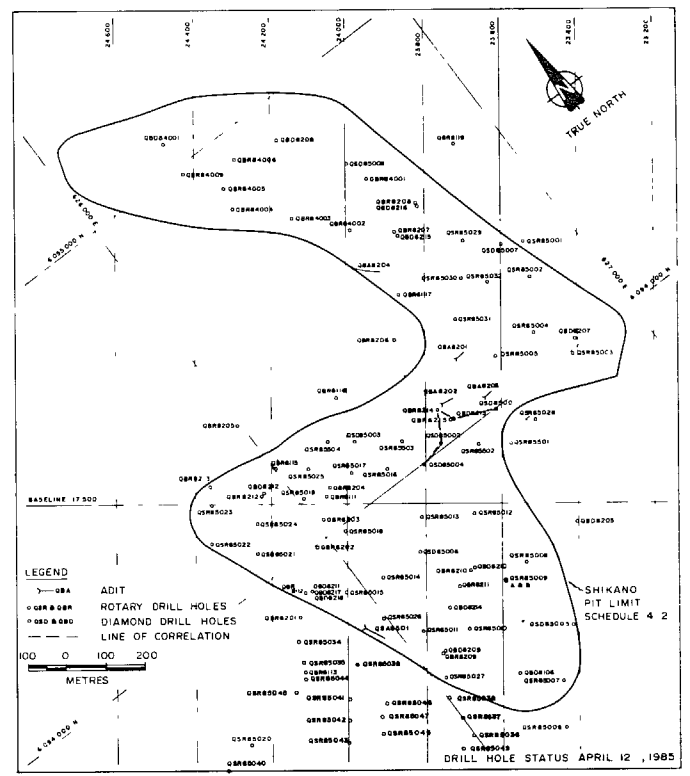

G SEAM

Rev	D	M	Y	Revision Description	Drn	Des	App.
0			23/05/85	ORIGINAL DRAFT	KJV	Y T	Y T

QUINTETTE COAL LIMITED
Project Manager

DENISON MINES LIMITED
COAL DIVISION

Area: SHIKANO Category: CORRELATION

Drawing Title:
F & G SEAMS
DETAILED SEAM CORRELATIONS

SHEET 1 OF 3

Scale	Drawing No	Rev
1:50 (VERT)	85-300-26-02	0

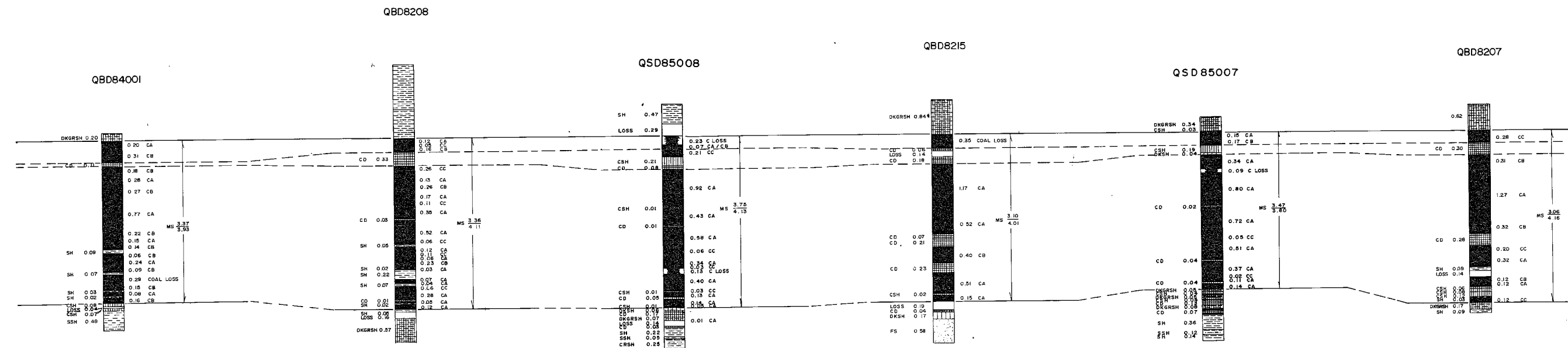

F SEAM

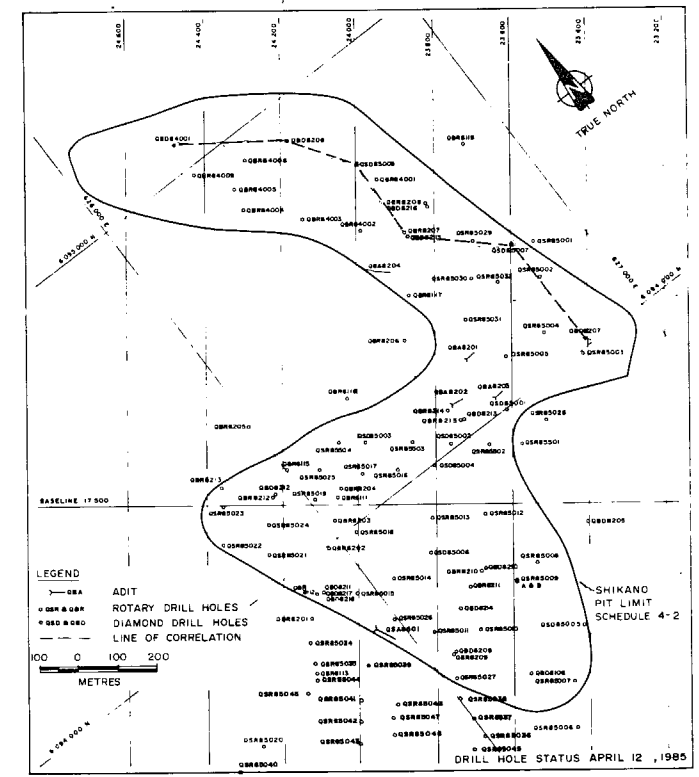

LEGEND

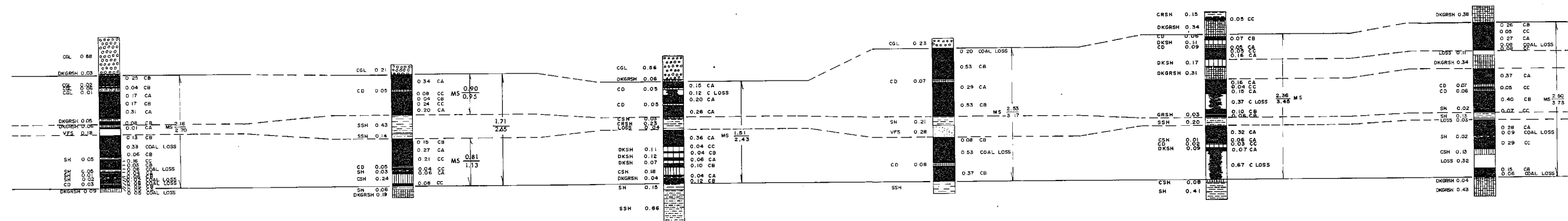
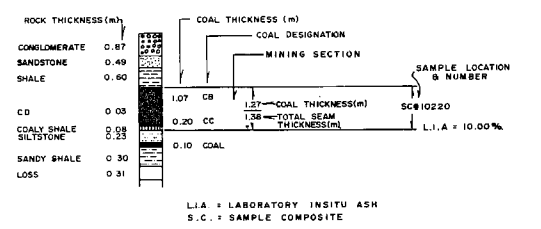

G SEAM

NOTE: CONGLOMERATE IN THE SEAM MAY BE THE RESULT OF FAULTING, RE-DRILL MATERIAL OR CHANNEL SCOUR

0	23/05/85	ORIGINAL DRAFT	KJV	YT	YT
Rev.	D	M	Y	Revision Description	Drn. Des. App.
QUINETTE COAL LIMITED					
Project Manager					
DENISON MINES LIMITED					
COAL DIVISION					
Area SHIKANO			Category CORRELATION		
Drawing Title					
F & G SEAMS					
DETAILED SEAM CORRELATIONS					
SHEET 2 OF 3					
Scale	Drawing No.		Rev.		
1:50 (VERT.)	85-300-26-02		0		

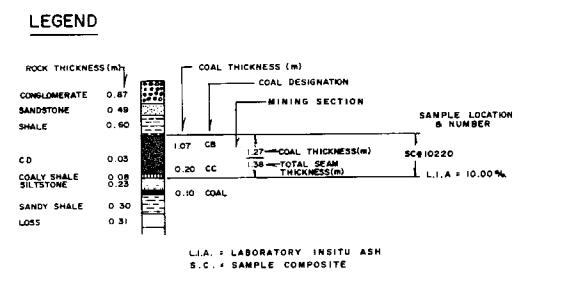
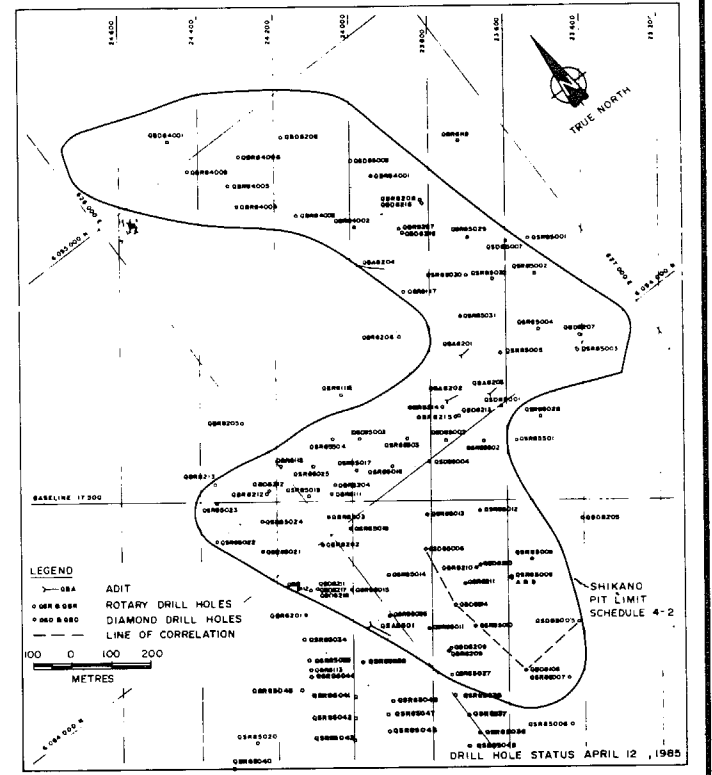
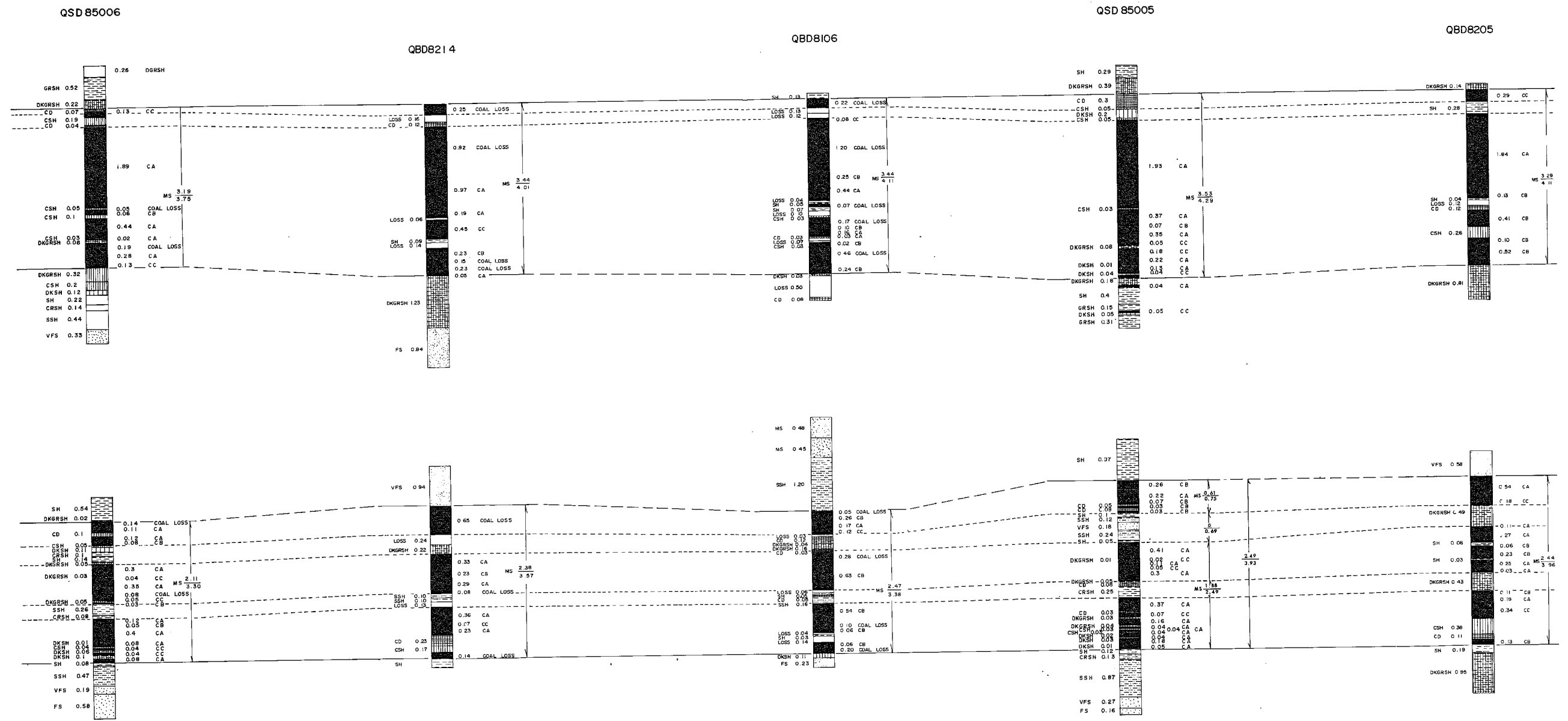

Rev.	D	M	Y	Revision Description	Drn.	Des.	App.

QUINTETTE COAL LIMITED
Project Manager

DENISON MINES LIMITED
COAL DIVISION

Area: _____ Category: _____

Drawing Title

**F & G SEAMS
DETAILED SEAM CORRELATION**

SHEET 3 OF 3

Scale: 1:50 (VERT.) Drawing No. 85-300-26-02 Rev. _____

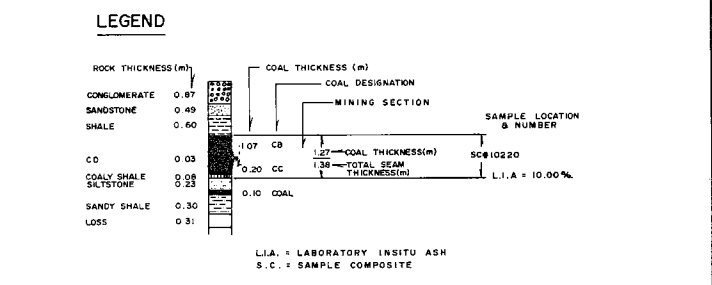
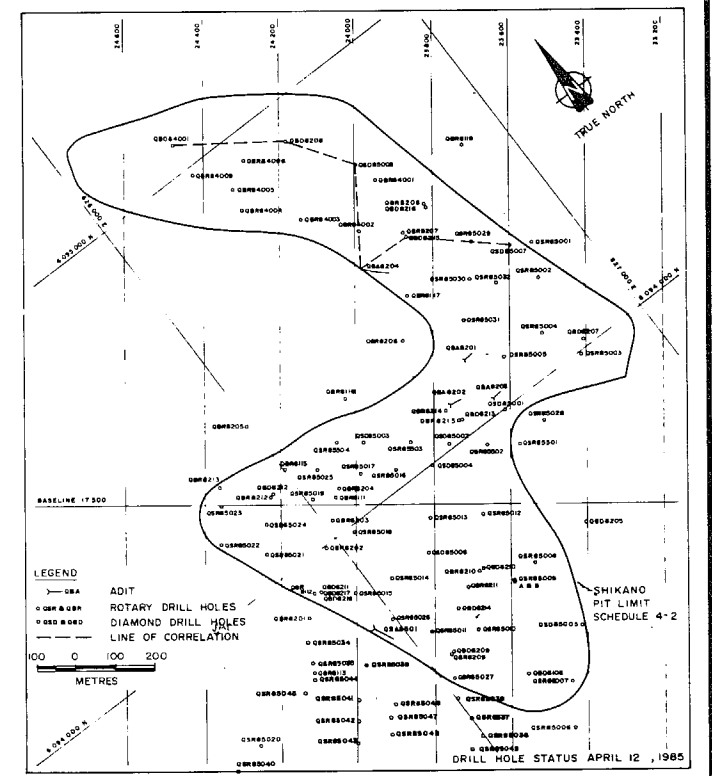
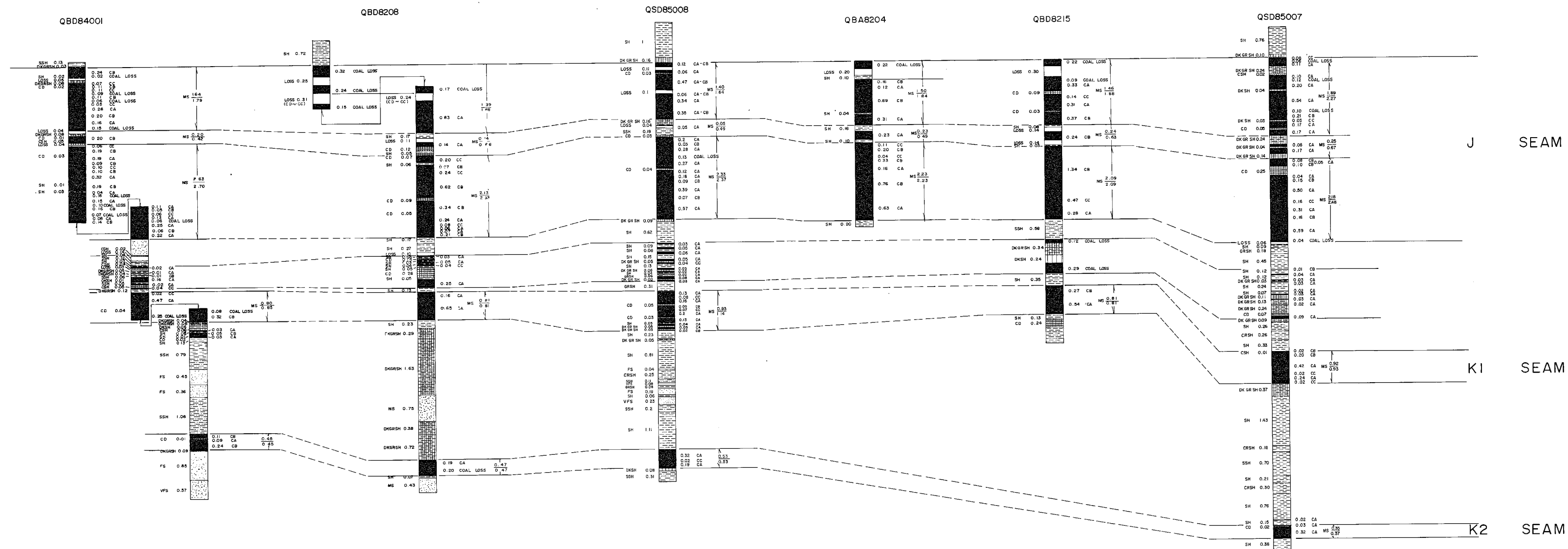

Rev.	D	M	Y	Revision Description	Drn.	Des.	App.
------	---	---	---	----------------------	------	------	------

QUINTETTE COAL LIMITED
Project Manager

DENISON MINES LIMITED
COAL DIVISION

Area: _____ Category: _____

Drawing Title:
**J & K SEAMS
DETAILED SEAM CORRELATION**

SHEET 1 OF 4

Scale: 1:50 (VERT.) Drawing No. 85-300-26-02 Rev. 0

QSD85003

QSD85004

QSD85002

QSD8213

QBA8201

QSD85001

QSD8207

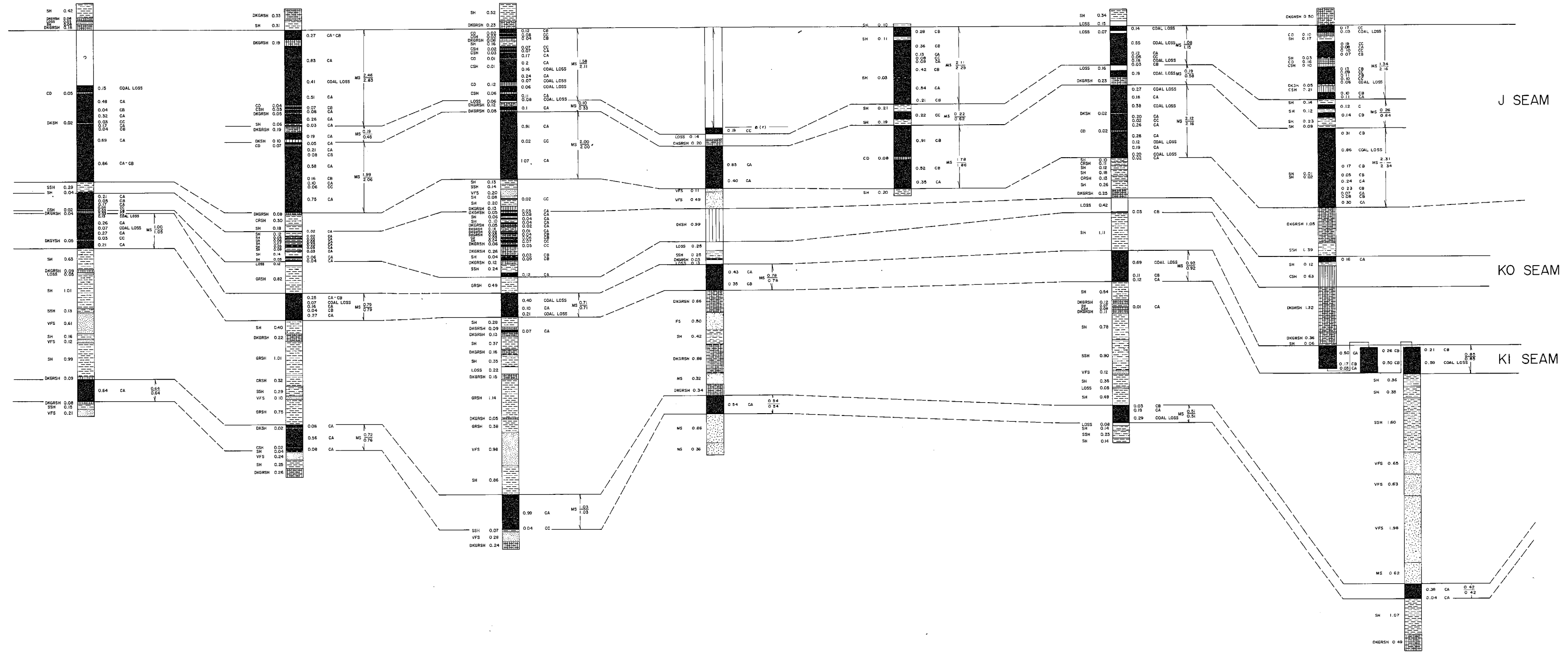

J SEAM

KO SEAM

KI SEAM

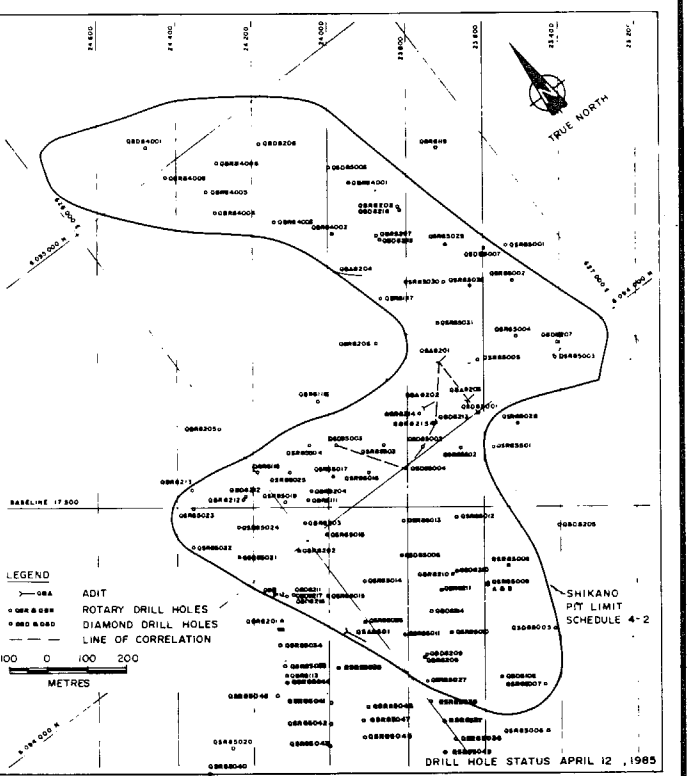

LEGEND

ROCK THICKNESS (m)	COAL THICKNESS (m)	COAL DESIGNATION	SAMPLE LOCATION
CONGLOMERATE 0.87	0.107 CB	MINING SECTION	SCH10220
SANDSTONE 0.49	0.20 CC	MINING SECTION	L.I.A. + 10.00%
SHALE 0.90	0.27 COAL THICKNESS	MINING SECTION	
	0.20 CC	MINING SECTION	
CD 0.03	0.10 COAL	MINING SECTION	
COAL SHALE 0.03		MINING SECTION	
SILTSTONE 0.38		MINING SECTION	
SANDY SHALE 0.30		MINING SECTION	
LOSS 0.31		MINING SECTION	

L.I.A. = LABORATORY INSITU ASH
 S.C. = SAMPLE COMPOSITE

Rev.	D.	M.	Y.	Revision Description	Drn.	Des.	App.
------	----	----	----	----------------------	------	------	------

QUINTETTE COAL LIMITED
 Project Manager
DENISON MINES LIMITED
 COAL DIVISION

Area	Category
------	----------

Drawing Title
J & K SEAMS
DETAILED SEAM CORRELATION

Scale	Drawing No.	Rev.
1:50 (VERT)	85-300-26-02	0

SHEET 2 OF 4

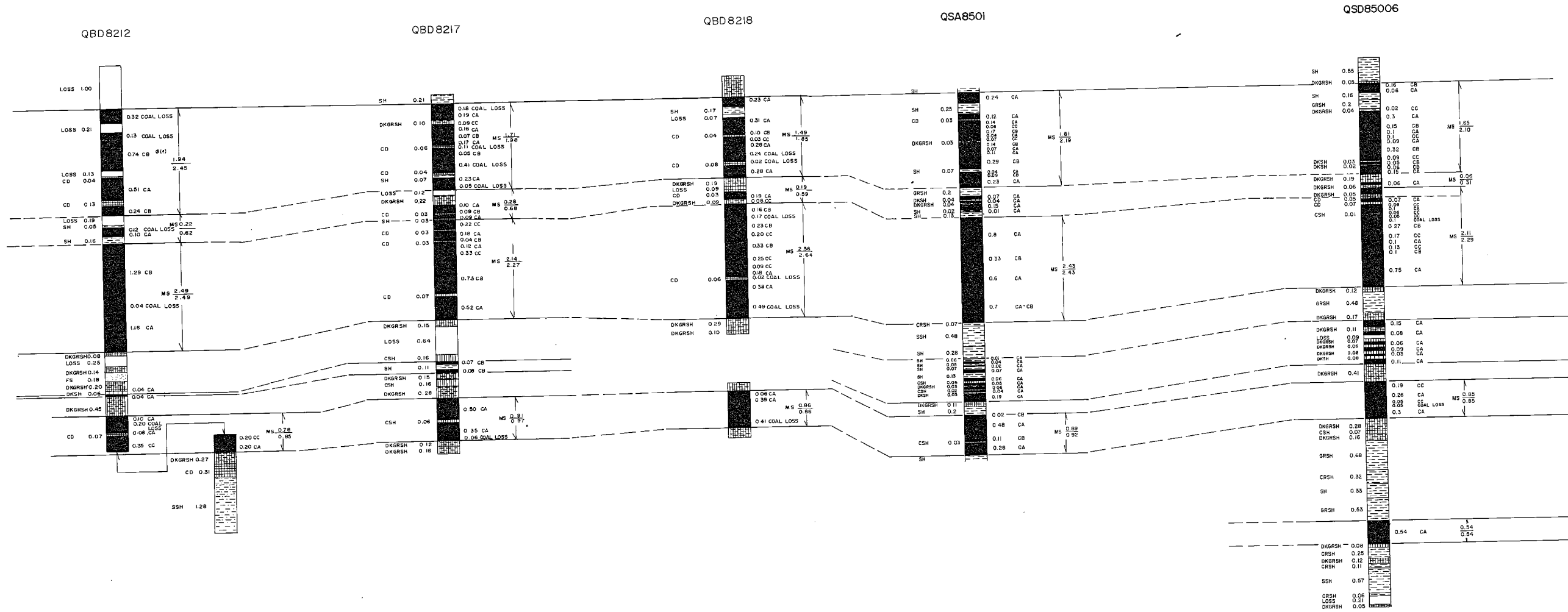

J SEAM
 KO SEAM
 KI SEAM
 K2 SEAM

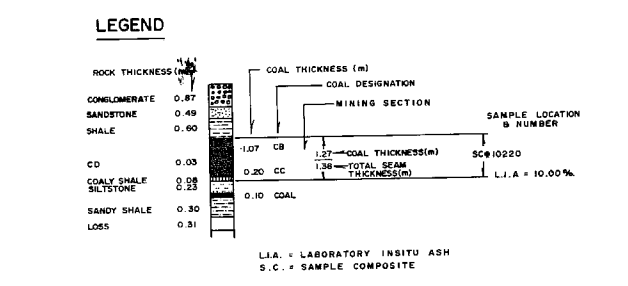
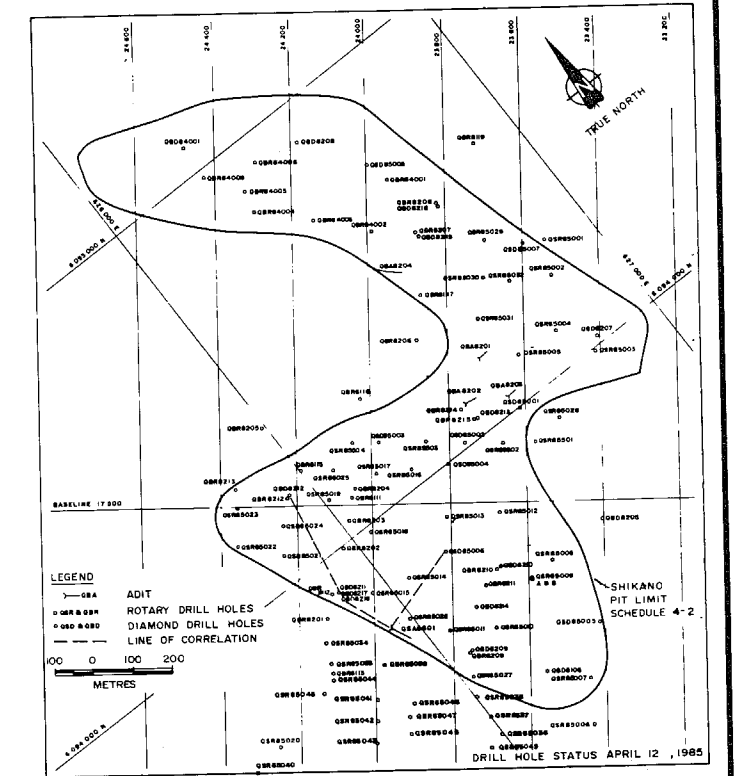

Rev.	D	M	Y	Revision Description	Drn.	Des.	App.

QUINTETTE COAL LIMITED
 Project Manager
DENISON MINES LIMITED
 COAL DIVISION

Area: _____ Category: _____

Drawing Title
J & K SEAMS
DETAILED SEAM CORRELATION

SHEET 3 OF 4

Scale 1: 50 (VERT.)	Drawing No. 85-300-26-02	Rev. 0
------------------------	-----------------------------	-----------

QSD85005

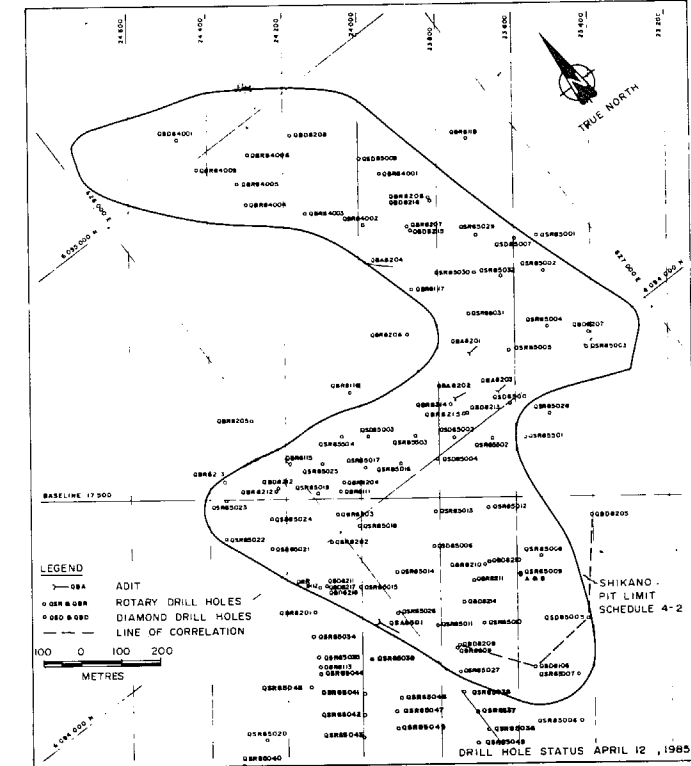
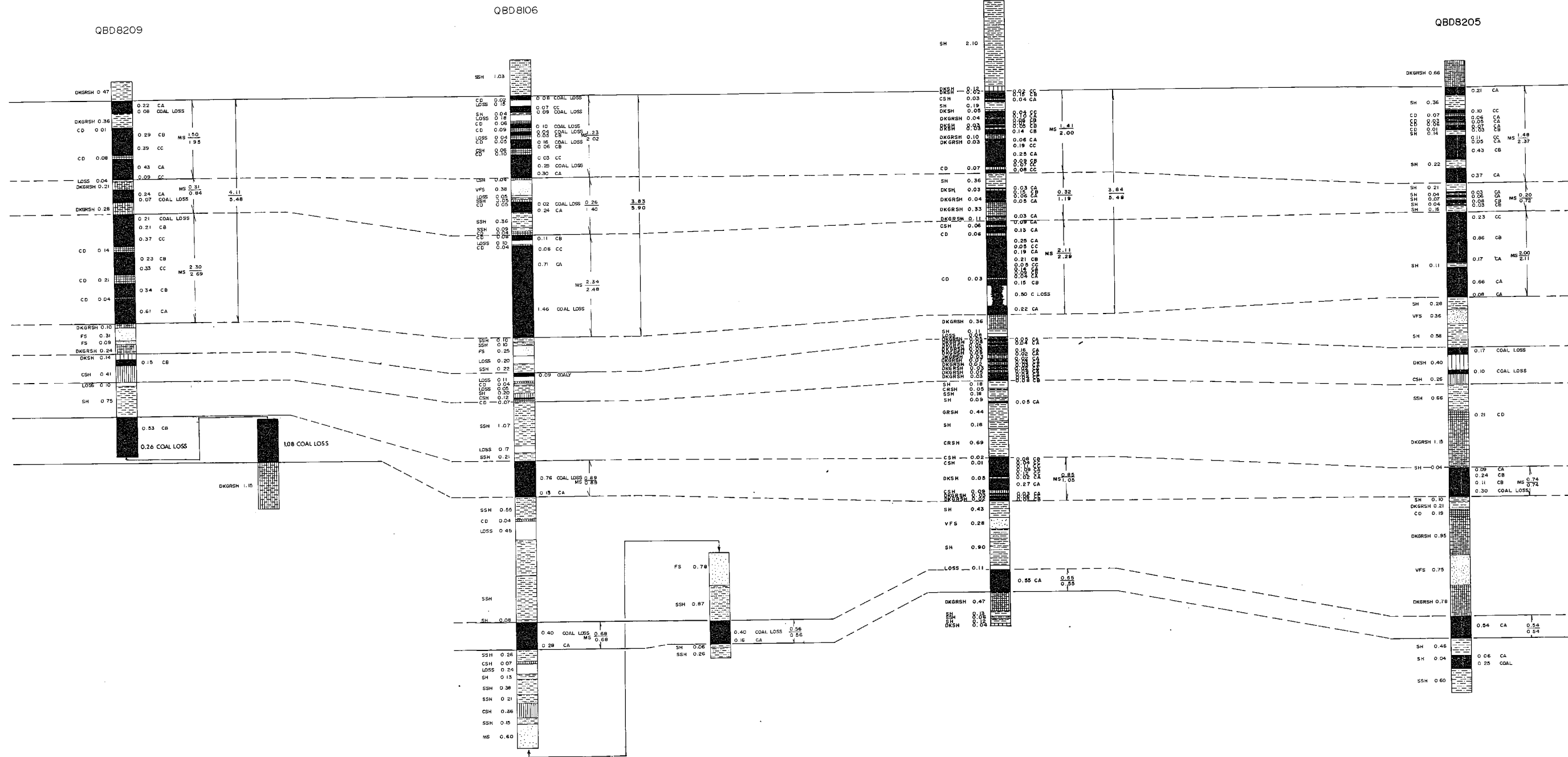

J SEAM

K0 SEAM

K1 SEAM

K2 SEAM

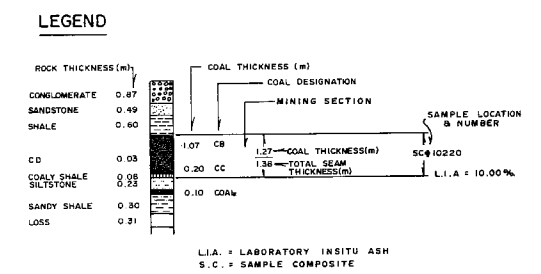

0	23/05/85	ORIGINAL DRAFT	KJV	YT	YT		
Rev.	D	M	Y	Revision Description	Drn.	Des.	App.

QUINTETTE COAL LIMITED
Project Manager
DENISON MINES LIMITED
COAL DIVISION

Area SHIKANO Category CORRELATION

Drawing Title
J & K SEAMS
DETAILED SEAM CORRELATIONS

SHEET 4 OF 4

Scale	Drawing No.	Rev.
1:50 (VERT.)	85-300-26-02	0

Supplement 3.2

Shikano Coal Seam Quality Summaries

QUINTETTE COAL LIMITED

SHIKANO GEOLOGICAL REPORT

APPENDIX 1

GEOLOGY MAPS, CHARTS, AND DRAWINGS

May 1985

GEOLOGICAL BRANCH
ASSESSMENT REPORT

00 619

CONFIDENTIAL

APPENDIX 1

SHIKANO GEOLOGY MAPS, CHARTS, AND DRAWINGS

- 1.1 Top of D Seam Structure Contour Map
Top of F Seam Structure Contour Map
Top of G Seam Structure Contour Map
Top of J Seam Structure Contour Map
Top of K Seam Structure Contour Map
- 1.2 Shikano Formation Correlation Chart
Shikano Middle Gates Correlation Chart (Sheet 1 & 2)
- 1.3 Shikano Overburden Isopach Map
- 1.4 Mining Section Thickness Isopach - D Seam
Mining Section Thickness Isopach - E2 Seam
Mining Section Thickness Isopach - F Seam
Mining Section Thickness Isopach - G Seam
Mining Section Thickness Isopach - J Seam
Mining Section Thickness Isopach - K1 Seam
- 1.5 Iso-In-Place Ash Map - D Seam
Iso-In-Place Ash Map - E2 Seam
Iso-In-Place Ash Map - F Seam
Iso-In-Place Ash Map - G Seam
Iso-In-Place Ash Map - J Seam
Iso-In-Place Ash Map - K1 Seam
- 1.6 Mine Grid Cross-Sections 23,200 to 24,700 (incl.)
- 1.7 Adit Drawings (5 sheets)
- 1.8 Shikano Drillhole Geophysical Log Correlation of
Coal-Bearing Section (20 sheets)
- 1.9 Coal Seam Data Summaries

APPENDIX 1

Section 1.1

Top of Seam Structure Contours

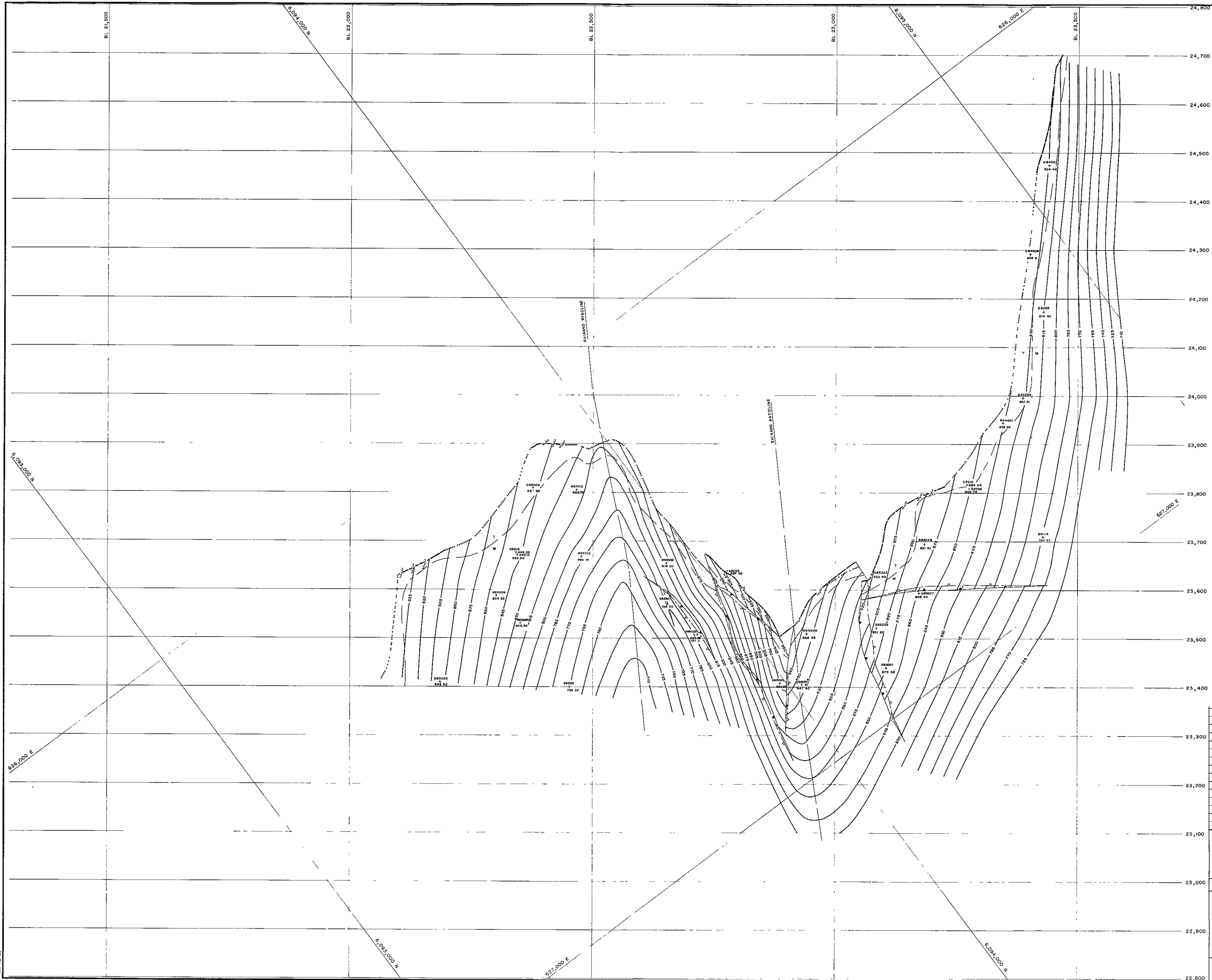

DCL FILE No.

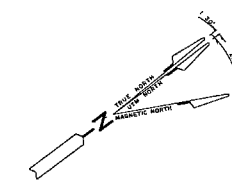

LEGEND

- 780 CONTOUR ELEVATION (10m INTERVALS)
- FAULT CONTACT UPPER PLATE
- FAULT CONTACT LOWER PLATE
- OUTCROP
- SUBCROP
- OXIDATION LIMIT

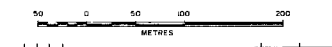

Rev.	D	M	Y	Revision Description	Drn	Des	App
0	12	03	95	ORIGINAL DRAFT	KJY	IK	IK

QUINTETTE COAL LIMITED
Project Manager
DENISON MINES LIMITED
COAL DIVISION

Area SHIKANO Category STRUCTURE CONTOUR

Drawing Title

SHIKANO
TOP OF D SEAM

Scale	Drawing No	Rev
1 2500	85-300-22-001	0

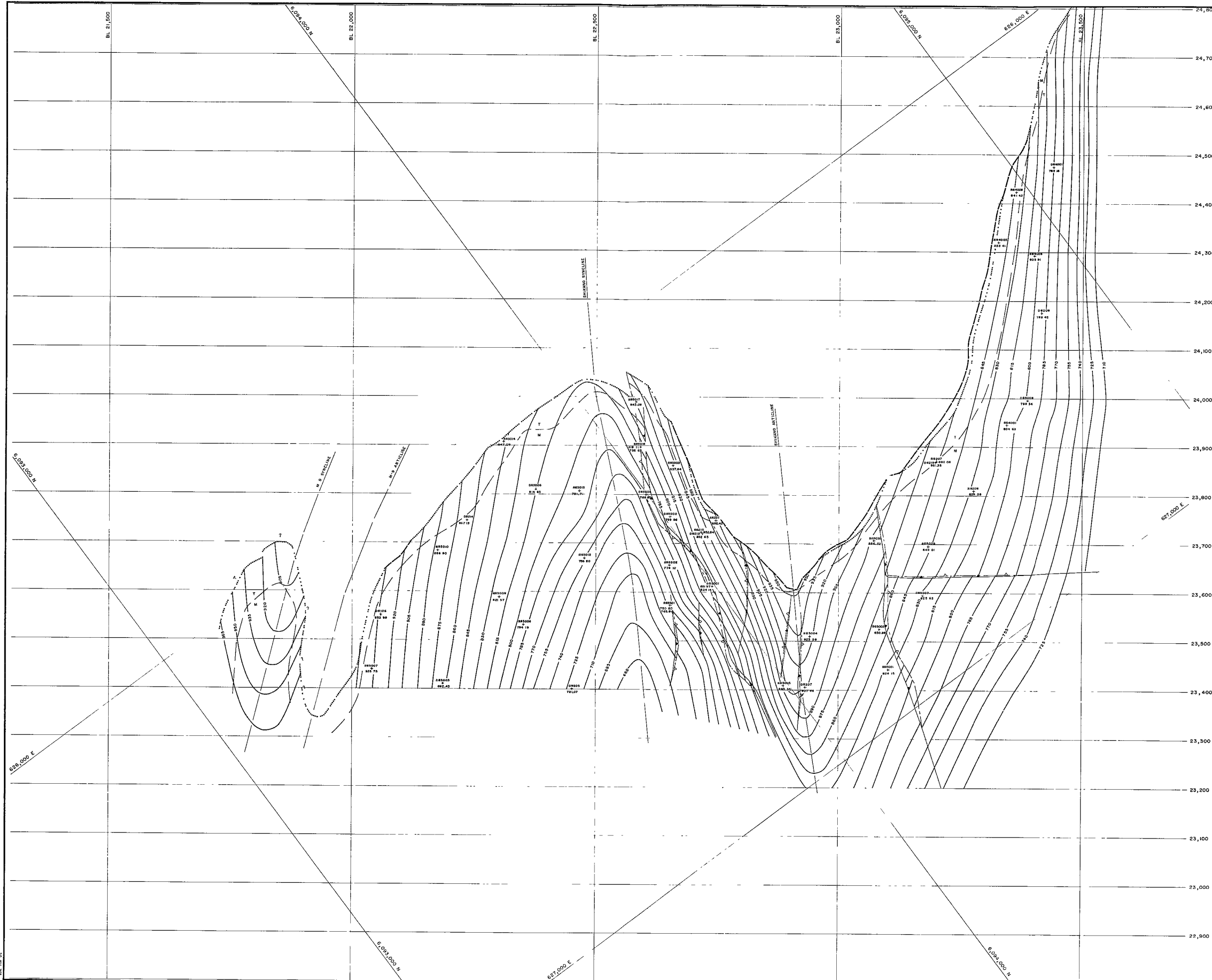

LEGEND

- 710 — CONTOUR ELEVATION (1:5m INTERVALS)
- ▲▲— FAULT CONTACT UPPER PLATE
- ▲▲— FAULT CONTACT LOWER PLATE
- - - - - OUTCROP
- - - - - SUBCROP
- - - - - OXIDATION LIMIT

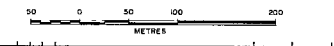

Rev	Q	M	Y	Revision Description	Drn	Des	App
0				ORIGINAL DRAFT	KJV	IK	TK

QUINETTE COAL LIMITED
 Project Manager
DENISON MINES LIMITED
 COAL DIVISION

Area: SHIKANO Category: STRUCTURE CONTOUR

Drawing Title
SHIKANO
TOP OF F SEAM

Scale: 1:2500 Drawing No: 85-300-22-003 Rev: 0

QCL FILE No.

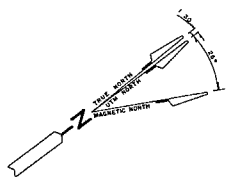

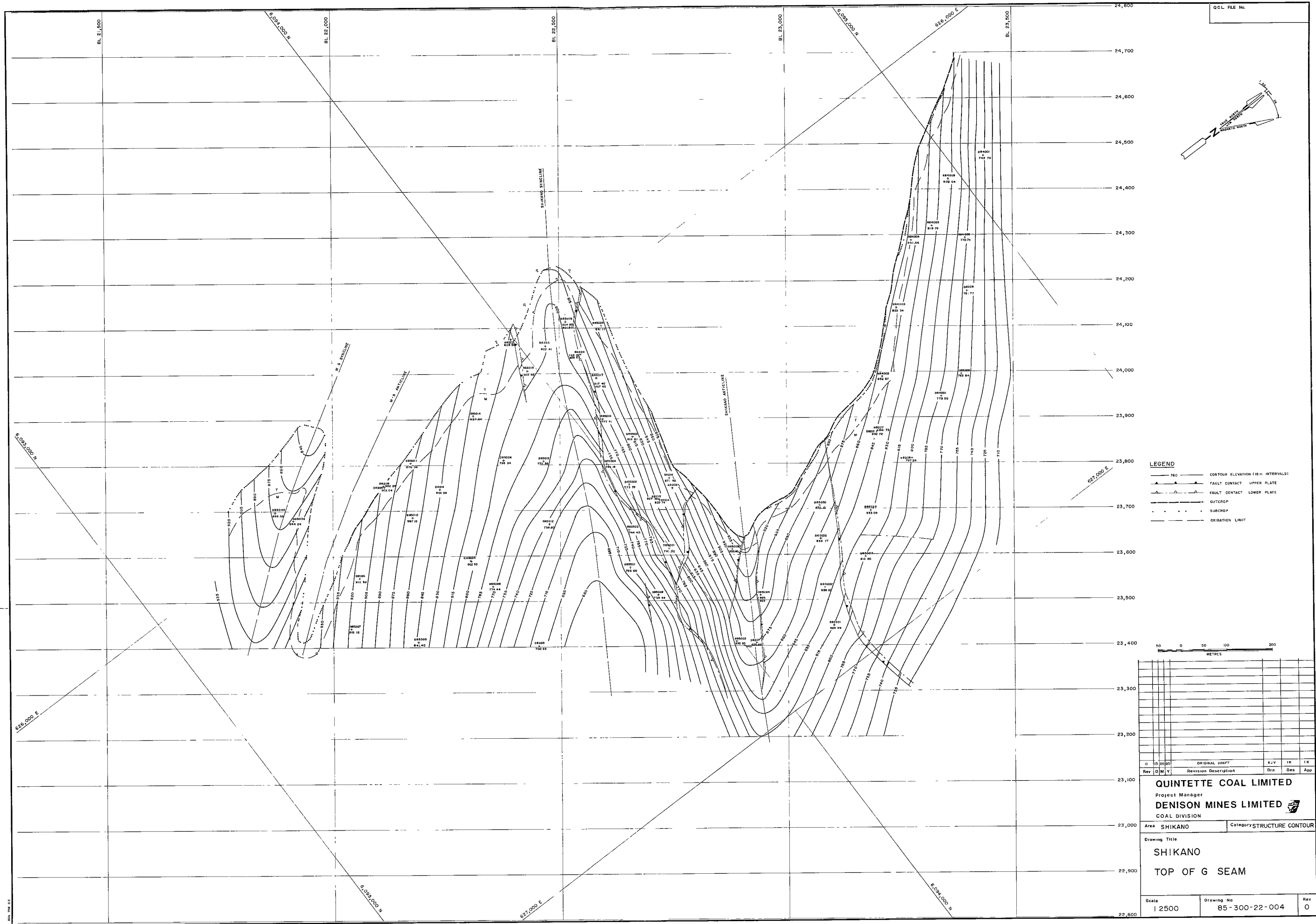

QCL FILE No.

- LEGEND**
- 1:500 CONTOUR ELEVATION (10m INTERVALS)
 - FAULT CONTACT UPPER PLATE
 - FAULT CONTACT LOWER PLATE
 - OUTCROP
 - SUBCROP
 - OXIDATION LIMIT



0	10	20	30	40	50	60	70	80	90	100	110	120	130	140	150	160	170	180	190	200
METRES																				

0 to 200m ORIGINAL DRAFT KJV JK JK
 Rev D M Y Revision Description Dra Des App

QUINTETTE COAL LIMITED
 Project Manager
DENISON MINES LIMITED
 COAL DIVISION

Area SHIKANO Category STRUCTURE CONTOUR

Drawing Title
SHIKANO
TOP OF G SEAM

Scale 1:2500 Drawing No 85-300-22-004 Rev 0

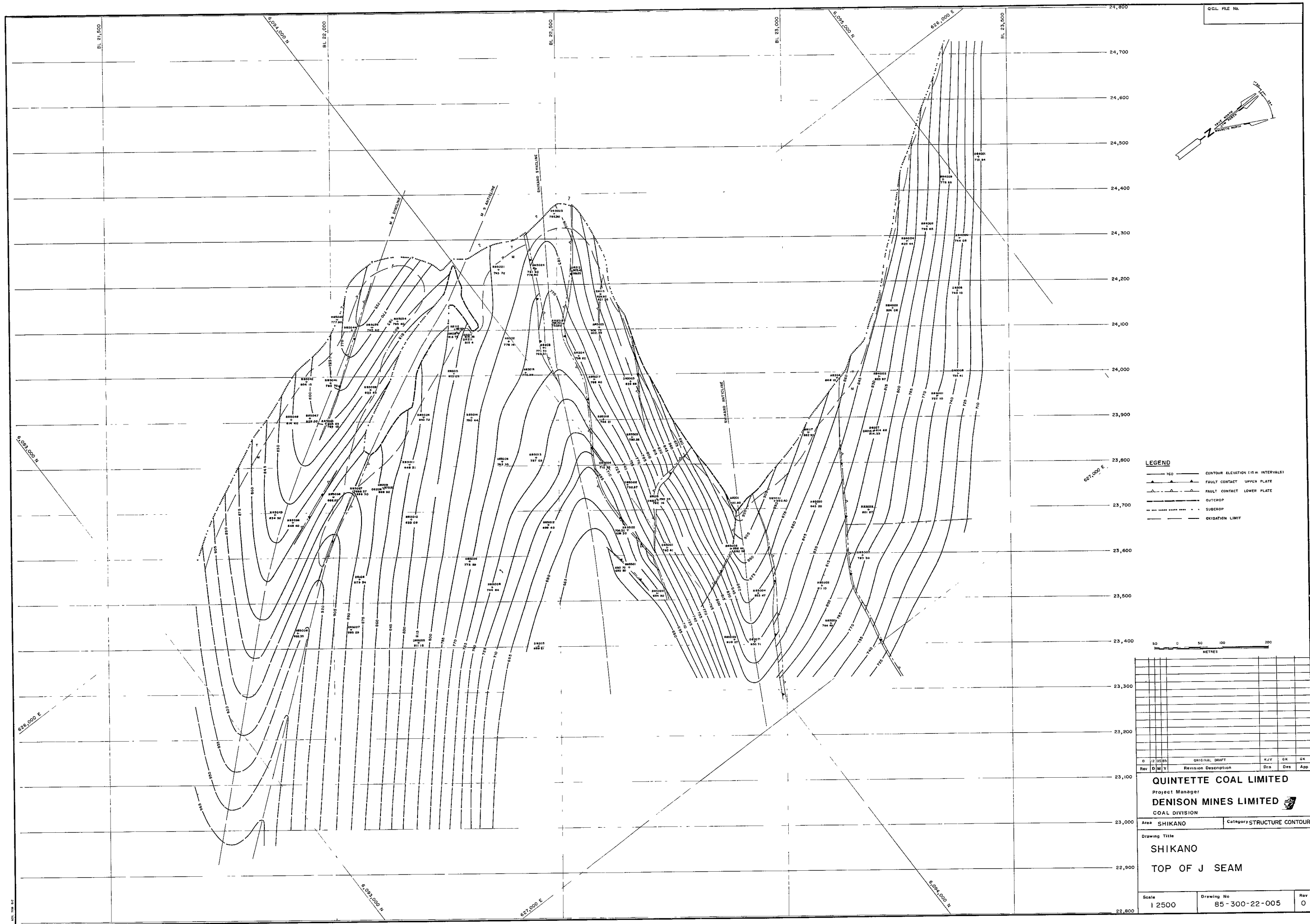

QCL FILE No.

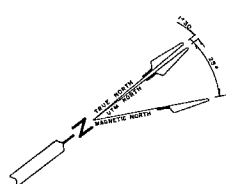

- LEGEND**
- 150 — CONTOUR ELEVATION (15 M INTERVALS)
 - ▲— FAULT CONTACT UPPER PLATE
 - △— FAULT CONTACT LOWER PLATE
 - OUTCROP
 - SUBCROP
 - OXIDATION LIMIT

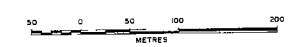

Rev	Date	Revision Description	Des	App
0	12/05/85	ORIGINAL DRAFT	N.J.V.	G.K.
1	01/01/86		D.R.	D.S.

QUINTETTE COAL LIMITED
 Project Manager
DENISON MINES LIMITED
 COAL DIVISION

Area: SHIKANO Category: STRUCTURE CONTOUR

Drawing Title
SHIKANO
TOP OF J SEAM

Scale: 1:2500 Drawing No: 85-300-22-005 Rev: 0

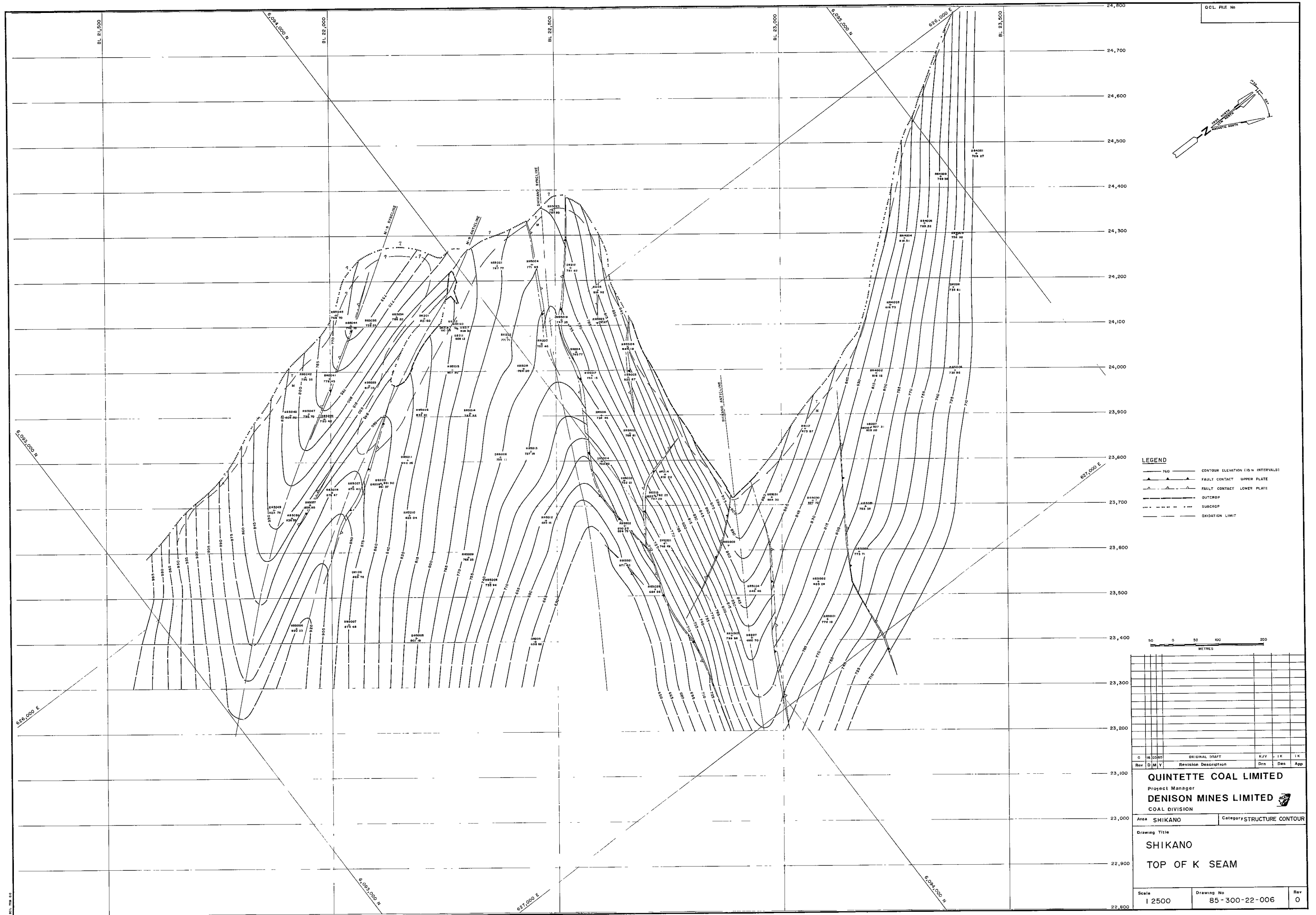

LEGEND

- 740 ——— CONTOUR ELEVATION (10 M INTERVALS)
- FAULT CONTACT UPPER PLATE
- FAULT CONTACT LOWER PLATE
- OUTCROP
- SUBCROP
- OXIDATION LIMIT

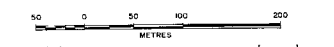

Rev	Date	Description	Drn	Des	App
0	16/05/05	ORIGINAL DRAFT	KJV	JK	JK

QUINTETTE COAL LIMITED
 Project Manager
DENISON MINES LIMITED
 COAL DIVISION

Area SHIKANO Category STRUCTURE CONTOUR
 Drawing Title
SHIKANO
TOP OF K SEAM

Scale 1:2500 Drawing No 85-300-22-006 Rev 0

APPENDIX 1

Section 1.2

Shikano Correlation Charts

(1:200 - 1:500)

NOT AVAILABLE FOR PRINTING

A COPY WILL BE FORWARDED A.S.A.P.

APPENDIX 1

Section 1.3

Shikano Overburden Isopach Map

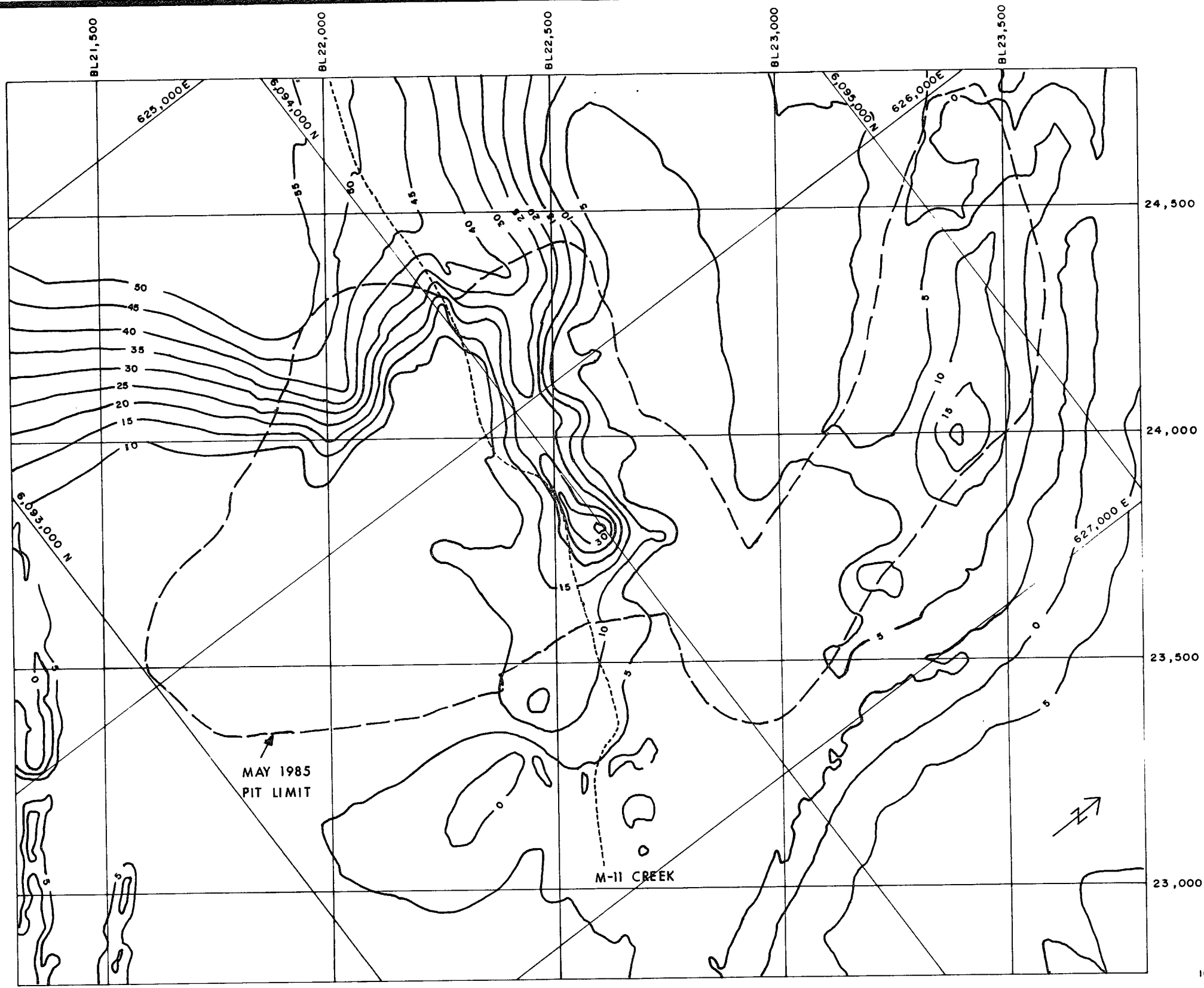

LEGEND

— 25 —
 CONTOUR INTERVAL 5.0 m



Date	21 / 05 / 85
Design	KTJ
Drawn	R.L.R
Scale	1 10,000

QUINTETTE COAL LIMITED
 Project Manager
DENISON MINES LIMITED
 COAL DIVISION



**SHIKANO
 GENERALIZED
 OVERBURDEN
 ISOPACH**

Drawing No	Rev 0
------------	----------

APPENDIX 1

Section 1.4

Seam Isopachs

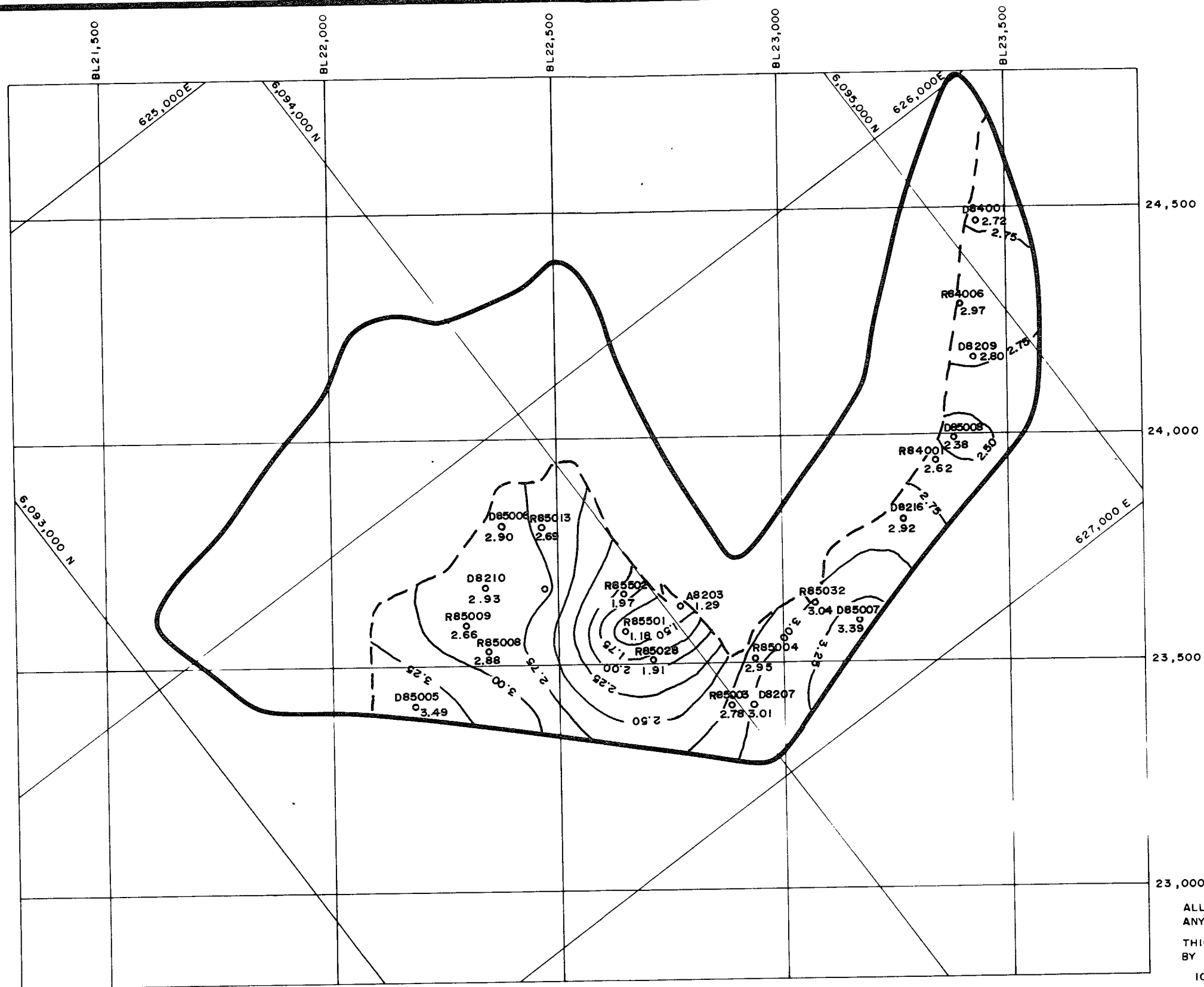

- LEGEND**
- 1.00 — M.S. THICKNESS CONTOUR ≥ 1.00 m (CONTOUR INTERVAL = 0.25 m)
 - - - 0.75 - - M.S. THICKNESS CONTOUR 0.75 m
 - QBDB207 DRILL HOLE (CORE)
 - QBDB119 DRILL HOLE (ROTARY)
 - QBA8203 ADIT
 - OUTCROP
 - PROPOSED PIT LIMIT

ALL DRILL HOLE LOCATIONS TAKE INTO CONSIDERATION ANY AVAILABLE DEVIATION DATA

THICKNESS ISOPACHS WERE GENERATED BY THE MINEPAK COMPUTER SYSTEM

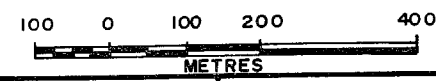

Date	21 / 05 / 85
Design	KTJ
Drawn	KJV
Scale	1 : 10,000

QUINTETTE COAL LIMITED
 Project Manager
DENISON MINES LIMITED
 COAL DIVISION

SHIKANO
D SEAM
M.S. THICKNESS ISOPACH
 Drawing No. _____ Rev. 0

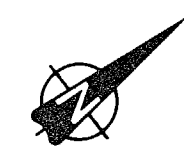
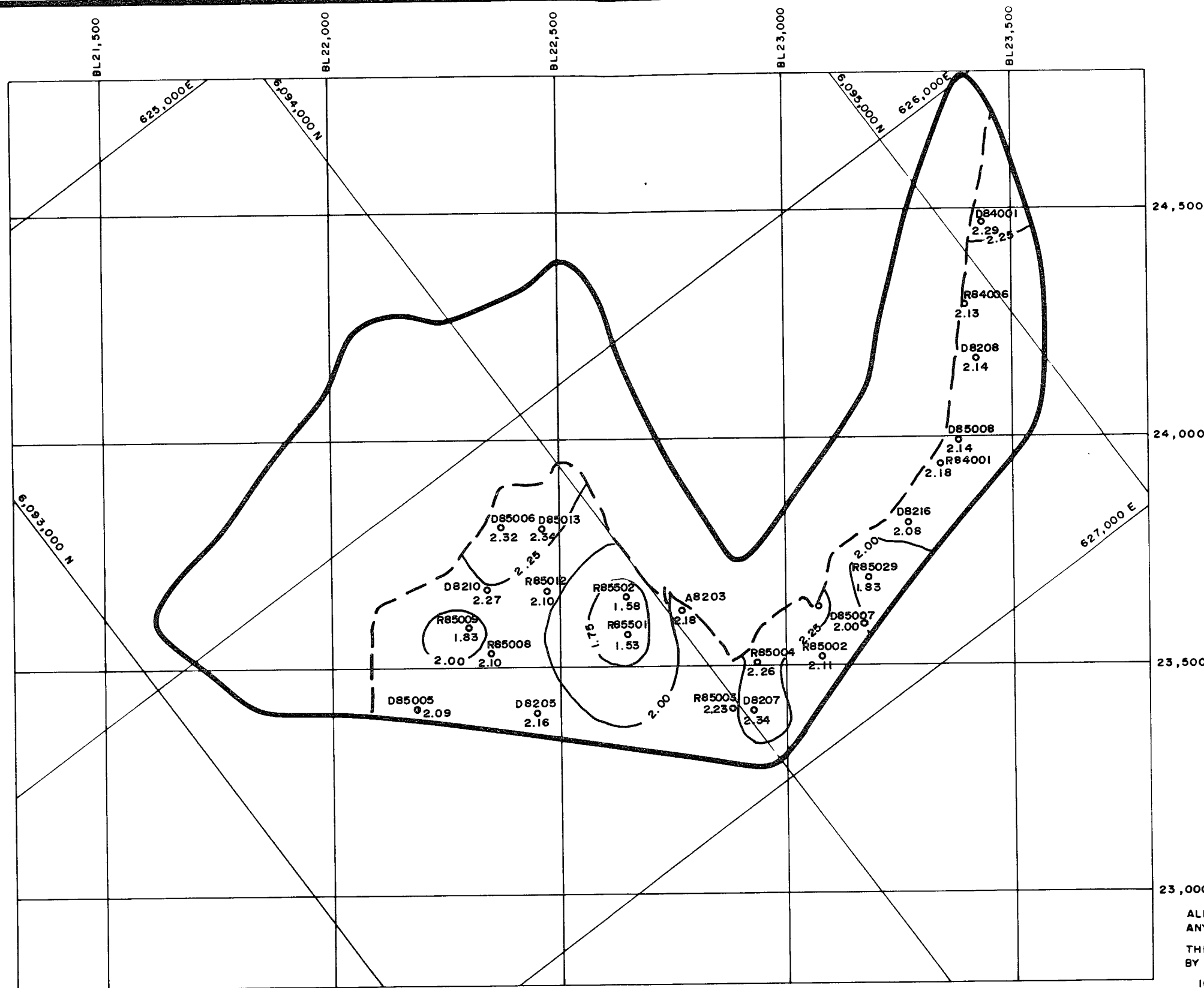

- LEGEND**
- 1.00 — M S THICKNESS CONTOUR 21.00m (CONTOUR INTERVAL 0.25m)
 - 0.75 --- M S THICKNESS CONTOUR 20.75m
 - QBD8207 DRILL HOLE (CORE)
2.57 MINING SECTION THICKNESS VALUE
 - QBR8119 DRILL HOLE (ROTARY)
2.54 MINING SECTION THICKNESS VALUE
 - QBA8203 ADIT
1.29 MINING SECTION THICKNESS VALUE
 - OUTCROP
 - PROPOSED PIT LIMIT

ALL DRILL HOLE LOCATIONS TAKE INTO CONSIDERATION ANY AVAILABLE DEVIATION DATA

THICKNESS ISOPACHS WERE GENERATED BY THE MINEPAK COMPUTER SYSTEM



Date	21/05/85
Design	KTJ
Drawn	KJV
Scale	1:10,000

QUINTETTE COAL LIMITED

Project Manager
DENISON MINES LIMITED
 COAL DIVISION

SHIKANO
E SEAM
M.S. THICKNESS ISOPACH

Drawing No _____ Rev 0

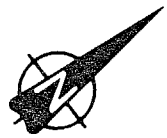
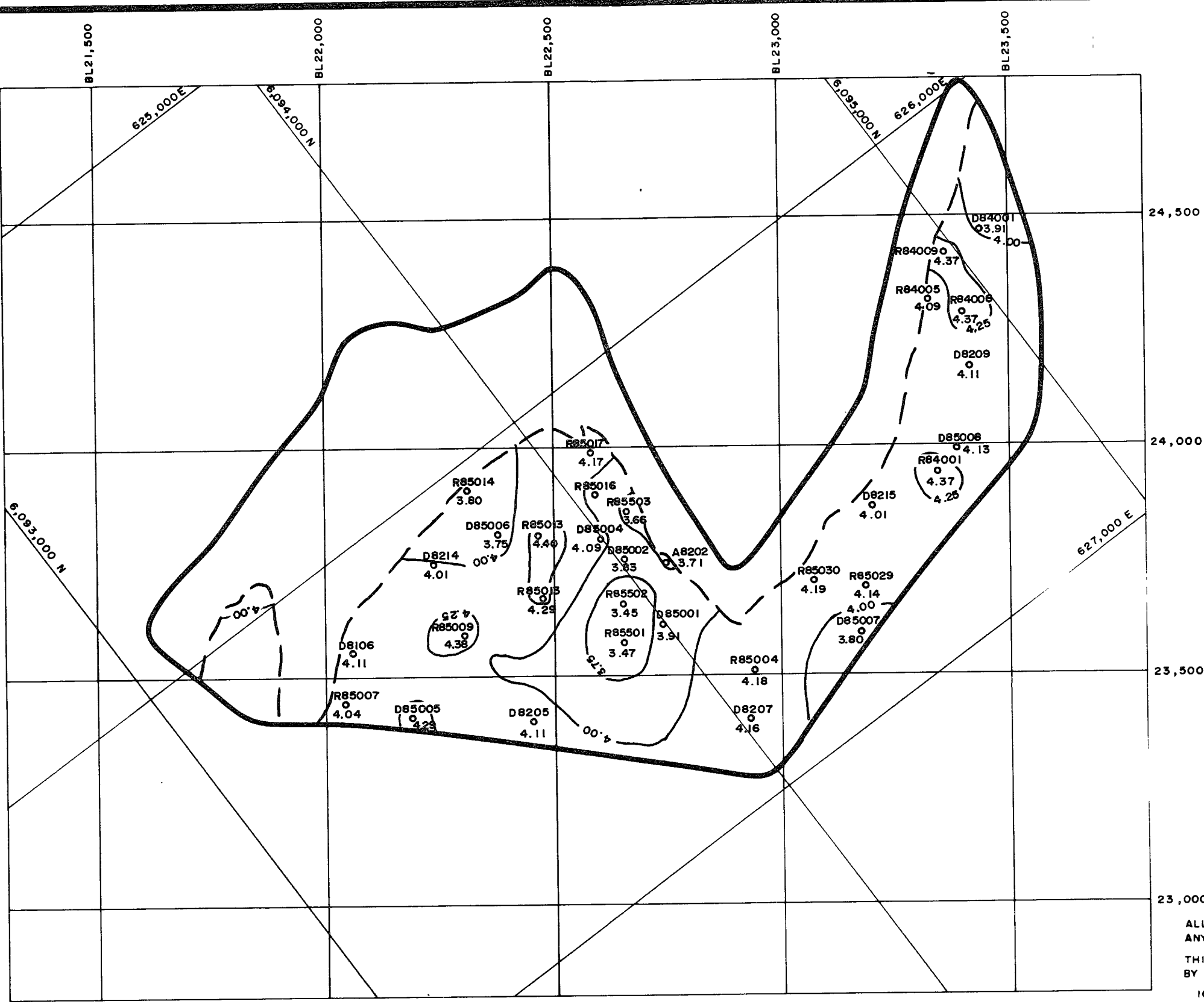

LEGEND
 -1.00- M S. THICKNESS CONTOUR 2100m
 (CONTOUR INTERVAL - 0.25m)
 --0.75-- M S. THICKNESS CONTOUR 2075m
 ○ QB8207 DRILL HOLE (CORE)
 ○ 2.57 MINING SECTION THICKNESS VALUE
 ○ QB8819 DRILL HOLE (ROTARY)
 ○ 2.54 MINING SECTION THICKNESS VALUE
 ○ QB8203 ADIT
 ○ 1.29 MINING SECTION THICKNESS VALUE
 --- OUTCROP
 ——— PROPOSED PIT LIMIT

ALL DRILL HOLE LOCATIONS TAKE INTO CONSIDERATION ANY AVAILABLE DEVIATION DATA

THICKNESS ISOPACHS WERE GENERATED BY THE MINEPAK COMPUTER SYSTEM



Date	21 / 05 / 85
Design	KTJ
Drawn	KJV
Scale	1 : 10,000

QUINTETTE COAL LIMITED
 Project Manager
DENISON MINES LIMITED
 COAL DIVISION

SHIKANO
F SEAM
M.S. THICKNESS ISOPACH
 Drawing No _____ Rev c

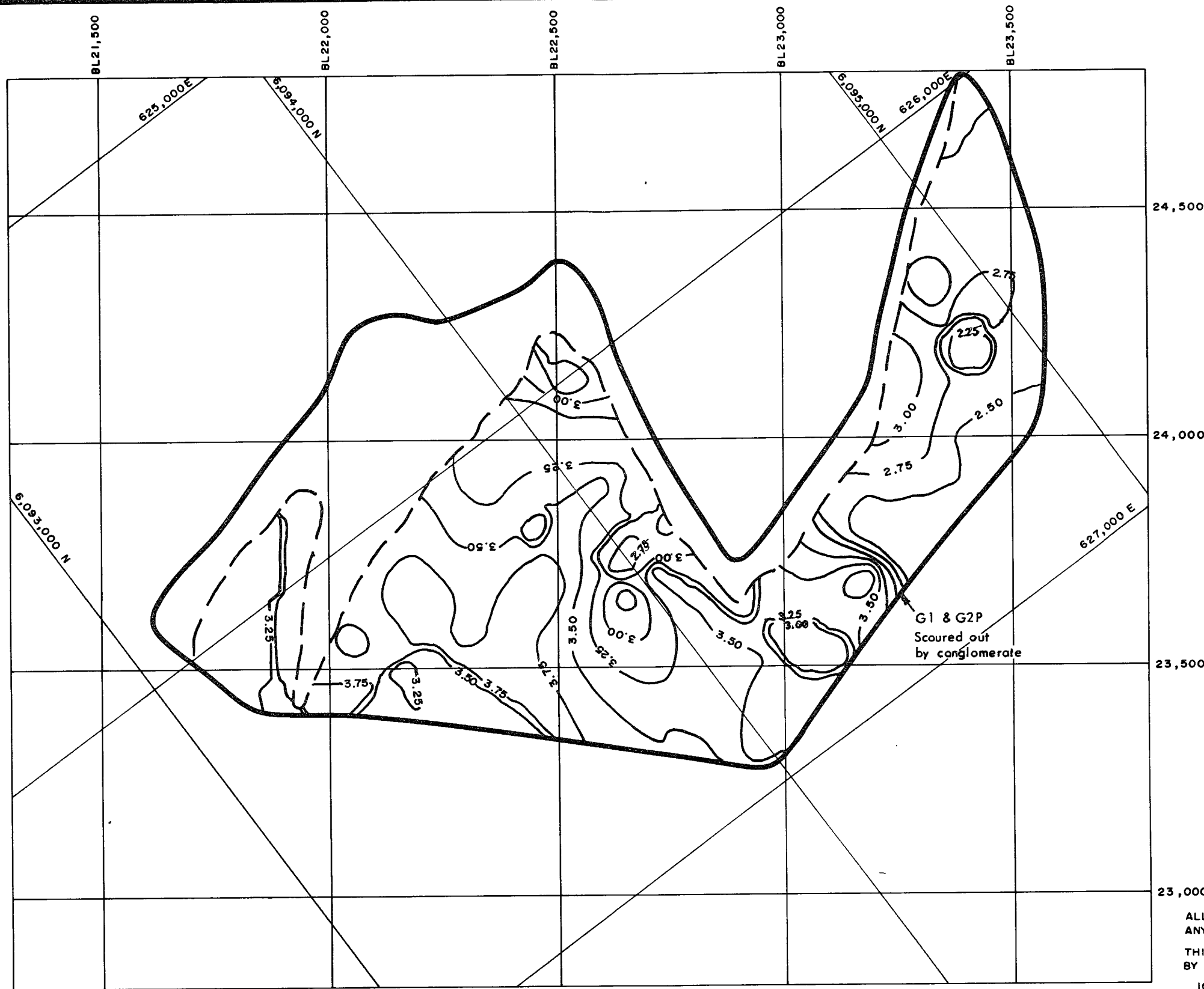

- LEGEND**
- 1.00 — M.S. THICKNESS CONTOUR 21.00m (CONTOUR INTERVAL - 0.25m)
 - - - 0.75 - - M.S. THICKNESS CONTOUR 20.75m
 - QB8207 DRILL HOLE (CORE)
2.57 MINING SECTION THICKNESS VALUE
 - QB8119 DRILL HOLE (ROTARY)
2.54 MINING SECTION THICKNESS VALUE
 - QB8203 ADIT
1.29 MINING SECTION THICKNESS VALUE
 - — — — — OUTCROP
 - — — — — PROPOSED PIT LIMIT

ALL DRILL HOLE LOCATIONS TAKE INTO CONSIDERATION ANY AVAILABLE DEVIATION DATA

THICKNESS ISOPACHS WERE GENERATED BY THE MINEPAK COMPUTER SYSTEM



Date	21 / 05 / 85
Design	KTJ
Drawn	KJV
Scale	1 : 10,000

QUINTETTE COAL LIMITED
Project Manager
DENISON MINES LIMITED
COAL DIVISION

**SHIKANO
G SEAM
COMPOSITE
THICKNESS**
Drawing No _____ Rev 0

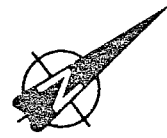
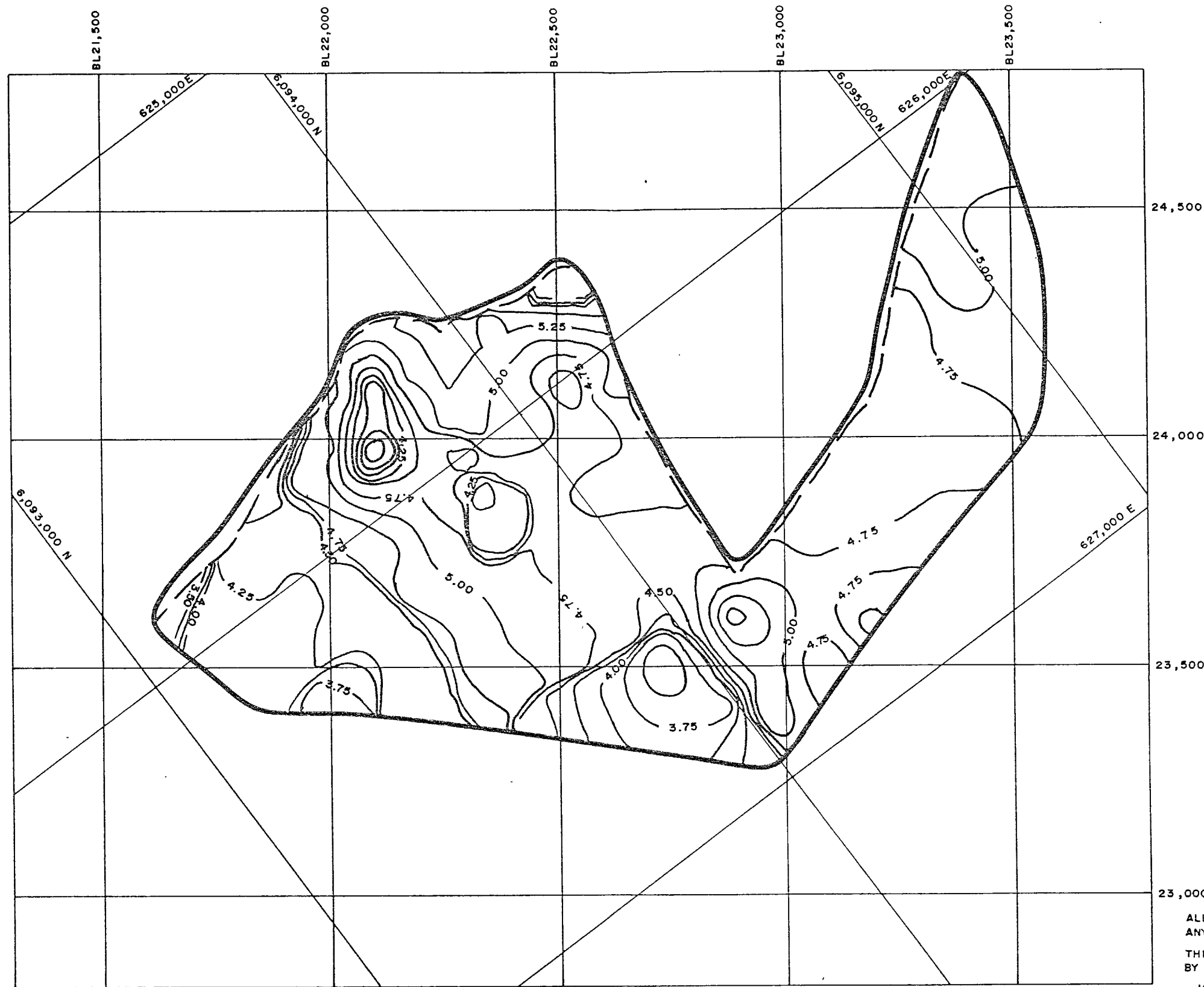

- LEGEND**
- 1.00 — M S. THICKNESS CONTOUR 21.00m (CONTOUR INTERVAL - 0.25m)
 - 0.75 --- M S. THICKNESS CONTOUR 20.75m
 - QB8207 DRILL HOLE (CORE)
2.57 MINING SECTION THICKNESS VALUE
 - QB8119 DRILL HOLE (ROTARY)
2.54 MINING SECTION THICKNESS VALUE
 - QB8203 ADIT
1.29 MINING SECTION THICKNESS VALUE
 - --- OUTCROP
 - — — PROPOSED PIT LIMIT

ALL DRILL HOLE LOCATIONS TAKE INTO CONSIDERATION ANY AVAILABLE DEVIATION DATA

THICKNESS ISOPACHS WERE GENERATED BY THE MINEPAK COMPUTER SYSTEM



Date	21 / 05 / 85
Design	KTJ
Drawn	KJV
Scale	1 : 10,000

QUINTETTE COAL LIMITED
 Project Manager
DENISON MINES LIMITED
 COAL DIVISION

SHIKANO
J SEAM
COMPOSITE THICKNESS
 Drawing No _____ Rev 0



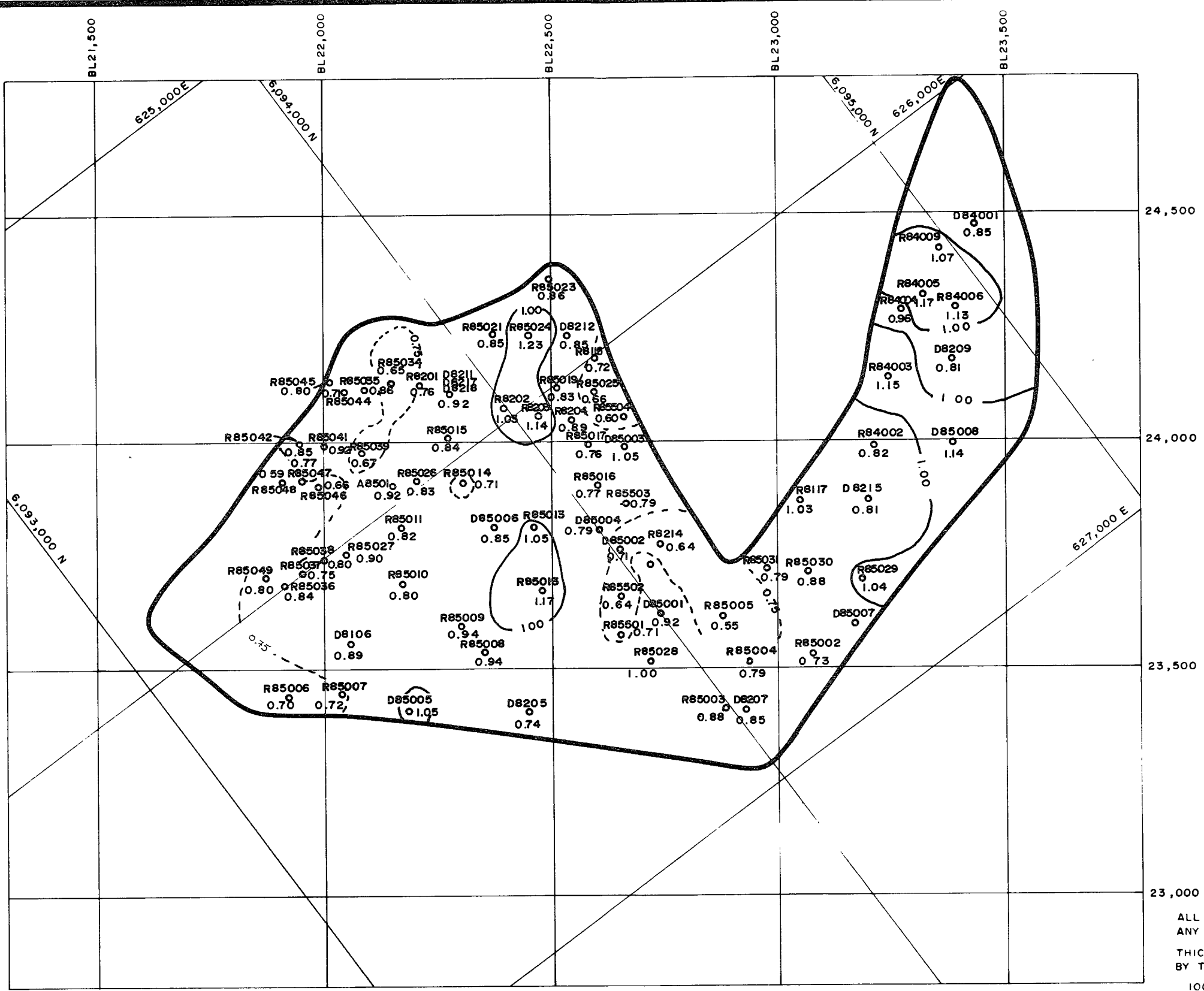

- LEGEND**
- 1.00 — M.S. THICKNESS CONTOUR 21.00m (CONTOUR INTERVAL - 0.25m)
 - - - 0.75 - - M.S. THICKNESS CONTOUR 20.75m
 - QBD8207 DRILL HOLE (CORE)
 - 2.57 MINING SECTION THICKNESS VALUE
 - R8119 DRILL HOLE (ROTARY)
 - 2.54 MINING SECTION THICKNESS VALUE
 - QBA8203 ADIT
 - 1.29 MINING SECTION THICKNESS VALUE
 - OUTCROP
 - PROPOSED PIT LIMIT

ALL DRILL HOLE LOCATIONS TAKE INTO CONSIDERATION ANY AVAILABLE DEVIATION DATA

THICKNESS ISOPACHS WERE GENERATED BY THE MINEPAK COMPUTER SYSTEM



Date	21/05/85
Design	KTJ
Drawn	KJV
Scale	1:10,000

QUINTETTE COAL LIMITED
 Project Manager
DENISON MINES LIMITED
 COAL DIVISION

SHIKANO
KI SEAM
M.S. THICKNESS ISOPACH
 Drawing No _____ Rev. 0

APPENDIX 1

Section 1.5

Seam Iso-Inplace Ash Contours

APPENDIX 1

Section 1.6

Mine Grid Cross-Sections

(23,200 - 24,700)

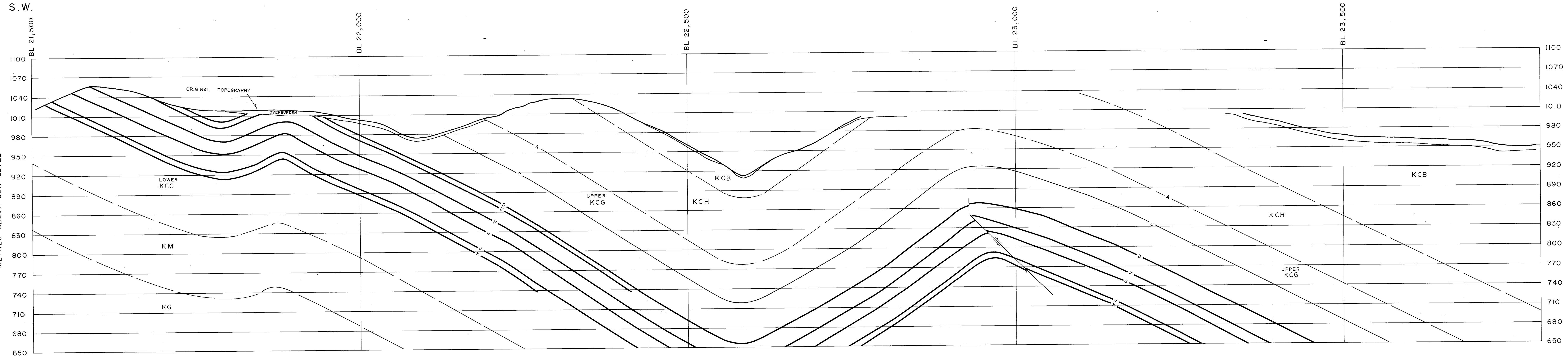

LEGEND

- DRILL HOLE LOCATION (SECTION)
- DRILL HOLE NUMBER
- DRILL HOLE
- BEDDING ANGLE IN CORE
- SEAM I.D., TOP OF SEAM
- PROJECTED APPARENT DIP IN SECTION OF OUTCROP
- TOP OF COAL SEAM
- FAULT WITH RELATIVE MOVEMENT
- FORMATION CONTACT

Scale: 0 50 100 200 METRES

0	14	05	85	ORIGINAL DRAFT	KJV	GK	GK
Rev.	D	M	Y	Revision Description	Drn.	Des.	App.

QUINTETTE COAL LIMITED
 Project Manager
DENISON MINES LIMITED
 COAL DIVISION

Area SHIKANO Category CROSS SECTION

Drawing Title
SHIKANO
CROSS SECTION 23,200

Scale 1:2500	Drawing No. 85-300-21-005	Rev. 0
-----------------	------------------------------	-----------

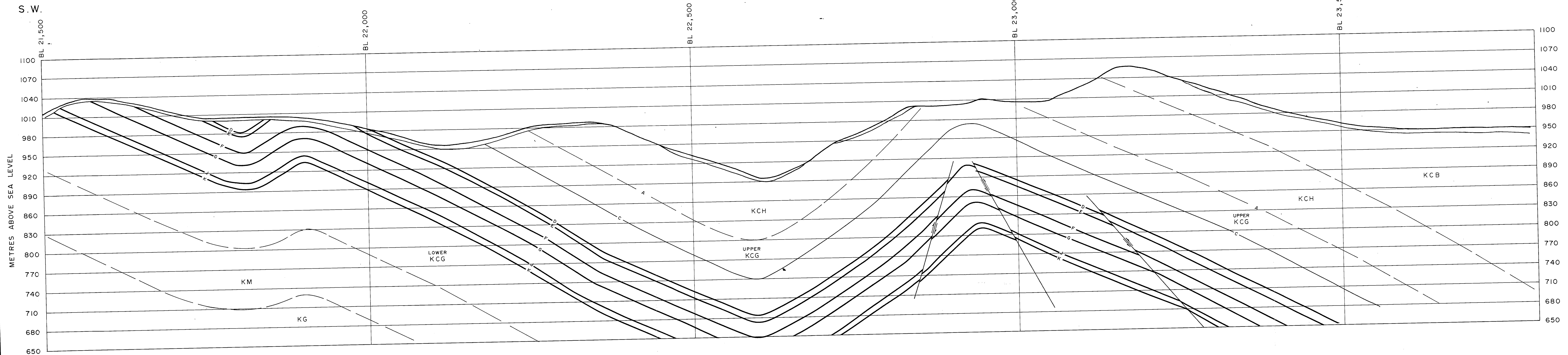

LEGEND

- DRILL HOLE LOCATION (SECTION)
- DRILL HOLE NUMBER
- DRILL HOLE
- BEDDING ANGLE IN CORE
- SEAM I.D., TOP OF SEAM
- PROJECTED APPARENT DIP IN SECTION OF OUTCROP
- TOP OF COAL SEAM
- FAULT WITH RELATIVE MOVEMENT
- FORMATION CONTACT

Scale: 0 50 100 200 METRES

0	14	05	85	ORIGINAL DRAFT	KJV	GK	GK
Rev.	D	M	Y	Revision Description	Drn.	Des.	App.
				QUINTETTE COAL LIMITED			
				Project Manager			
				DENISON MINES LIMITED			
				COAL DIVISION			
Area SHIKANO				Category CROSS SECTION			
Drawing Title							
SHIKANO							
CROSS SECTION 23,300							
Scale		Drawing No.		Rev.			
1:2500		85-300-21-006		0			

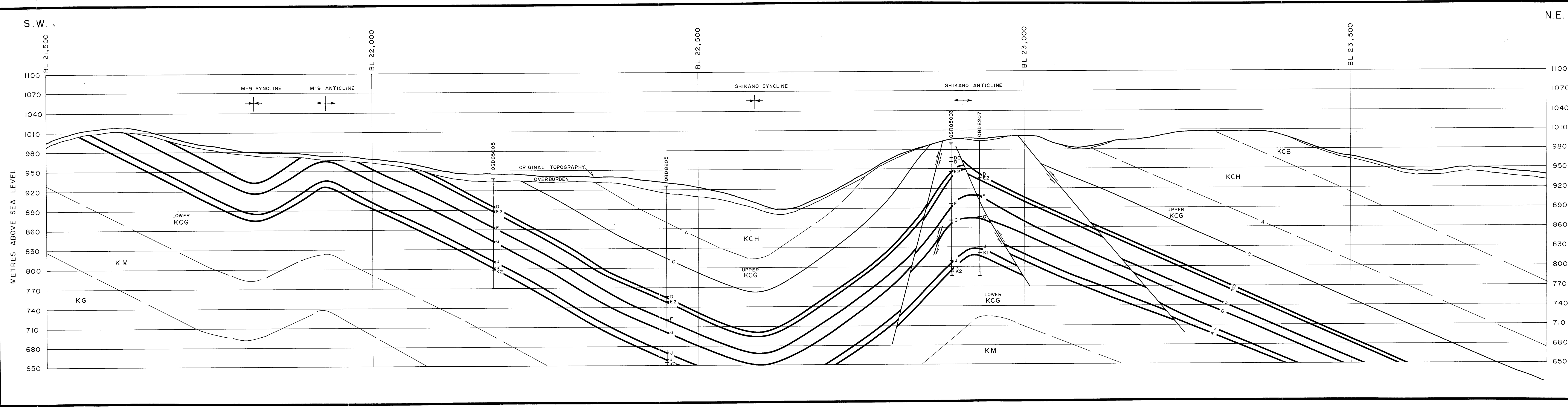

LEGEND

- DRILL HOLE LOCATION (SECTION)
- DRILL HOLE NUMBER
- DRILL HOLE
- BEDDING ANGLE IN CORE
- SEAM I.D., TOP OF SEAM
- PROJECTED APPARENT DIP IN SECTION OF OUTCROP
- TOP OF COAL SEAM
- FAULT WITH RELATIVE MOVEMENT
- FORMATION CONTACT

50 0 50 100 200 METRES

0	14	05	85	ORIGINAL DRAFT	KJV	GK	GK
Rev.	D	M	Y	Revision Description	Drn.	Des.	App.
QUINTETTE COAL LIMITED							
Project Manager							
DENISON MINES LIMITED							
COAL DIVISION.							
Area SHIKANO				Category CROSS SECTION			
Drawing Title							
SHIKANO							
CROSS SECTION 23,400							
Scale		Drawing No.			Rev.		
1:2500		85-300-21-007			0		

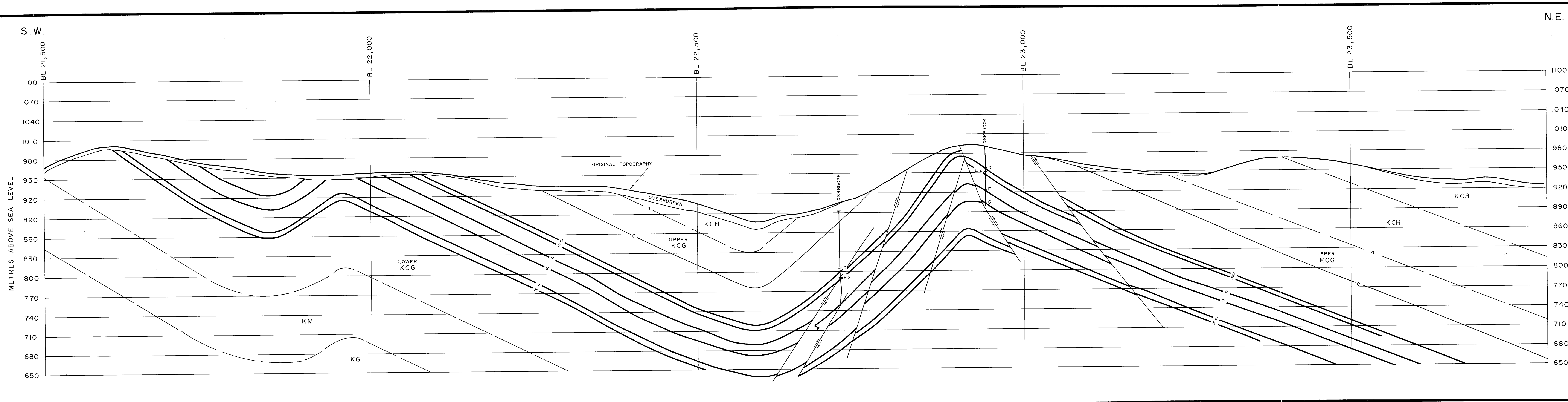

LEGEND

- DRILL HOLE LOCATION (SECTION)
- DRILL HOLE NUMBER
- DRILL HOLE
- BEDDING ANGLE IN CORE
- SEAM I.D., TOP OF SEAM
- PROJECTED APPARENT DIP IN SECTION OF OUTCROP
- TOP OF COAL SEAM
- FAULT WITH RELATIVE MOVEMENT
- FORMATION CONTACT

50 0 50 100 200 METRES

0	14	05	85	ORIGINAL DRAFT	KJV	GK	GK
Rev.	D	M	Y	Revision Description	Drn.	Des.	App.

QUINTETTE COAL LIMITED
 Project Manager
DENISON MINES LIMITED
 COAL DIVISION

Area SHIKANO Category CROSS SECTION

Drawing Title
SHIKANO
CROSS SECTION 23,500

Scale 1:2500	Drawing No. 85-300-21-008	Rev. 0
-----------------	------------------------------	-----------

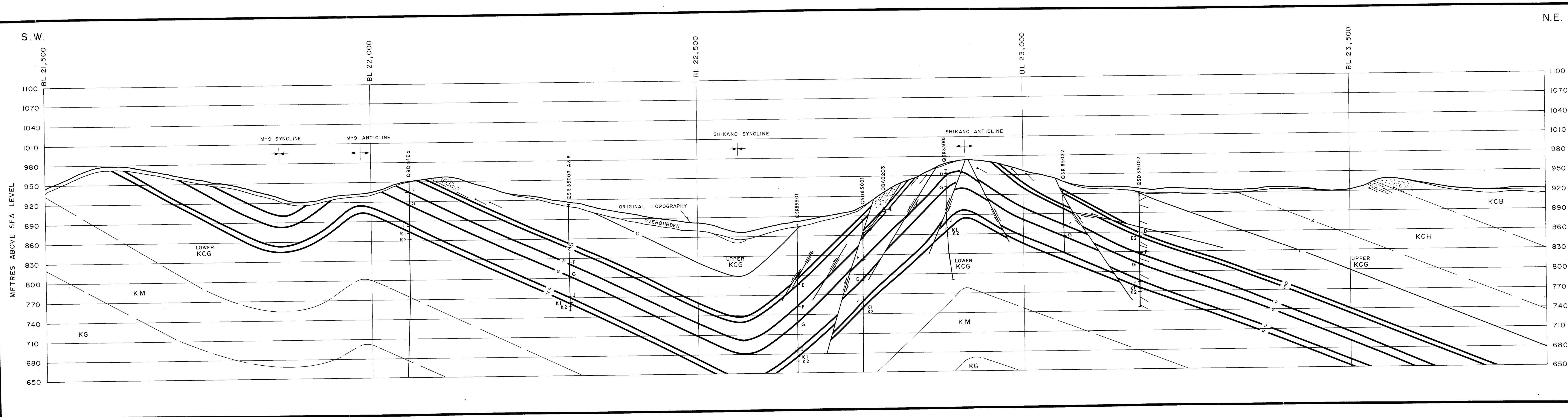

LEGEND

- DRILL HOLE LOCATION (SECTION)
- DRILL HOLE NUMBER
- DRILL HOLE
- BEDDING ANGLE IN CORE
- SEAM I.D., TOP OF SEAM
- PROJECTED APPARENT DIP IN SECTION OF OUTCROP
- TOP OF COAL SEAM
- FAULT WITH RELATIVE MOVEMENT
- FORMATION CONTACT

50 0 50 100 200 METRES

0	14	05	85	ORIGINAL DRAFT	KJV	GK	GK
Rev.	D	M	Y	Revision Description	Drn.	Des.	App.
QUINTETTE COAL LIMITED							
Project Manager							
DENISON MINES LIMITED							
COAL DIVISION							
Area SHIKANO				Category CROSS SECTION			
Drawing Title							
SHIKANO							
CROSS SECTION 23,600							
Scale		Drawing No.			Rev.		
1:2500		85-300-21-009			0		

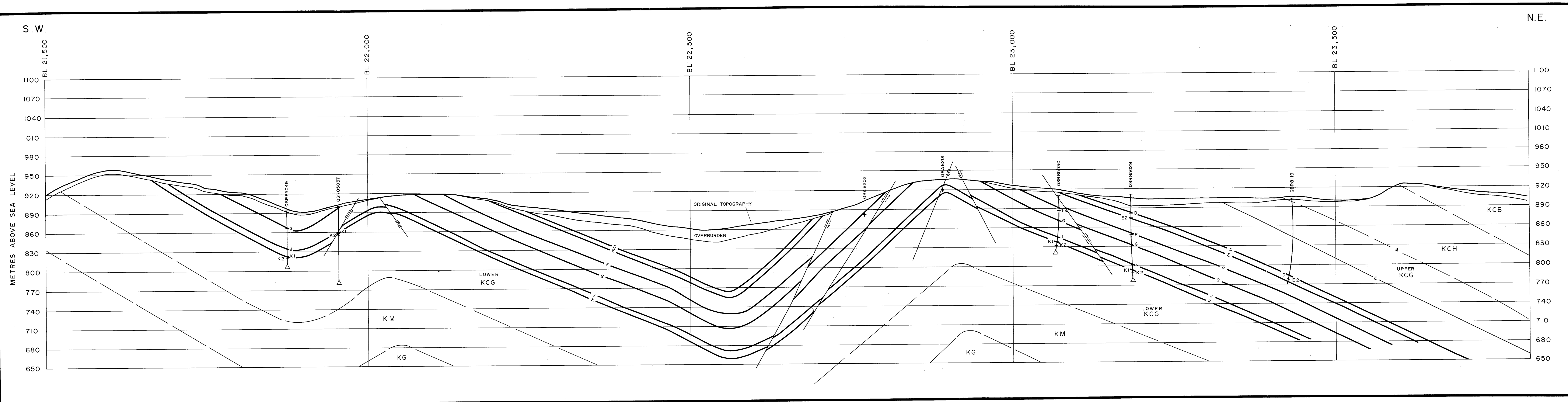

LEGEND

- DRILL HOLE LOCATION (SECTION)
- DRILL HOLE NUMBER
- DRILL HOLE
- BEDDING ANGLE IN CORE
- SEAM I.D., TOP OF SEAM
- PROJECTED APPARENT DIP IN SECTION OF OUTCROP
- TOP OF COAL SEAM
- FAULT WITH RELATIVE MOVEMENT
- FORMATION CONTACT

Scale: 0 50 100 200 METRES

0	14	05	85	ORIGINAL DRAFT	KJV	GK	GK
Rev.	D	M	Y	Revision Description	Drn.	Des.	App.

QUINTETTE COAL LIMITED
 Project Manager
DENISON MINES LIMITED
 COAL DIVISION

Area SHIKANO Category CROSS SECTION

Drawing Title
SHIKANO
CROSS SECTION 23,700

Scale 1:2500	Drawing No. 85-300-21-010	Rev. 0
-----------------	------------------------------	-----------

S.W.

N.E.

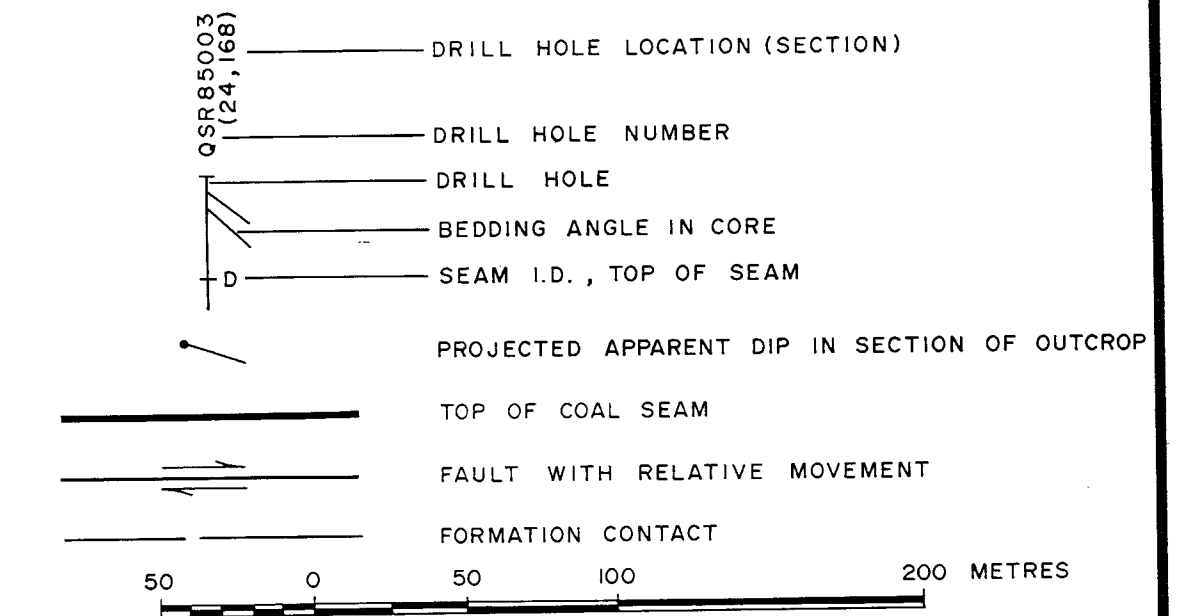
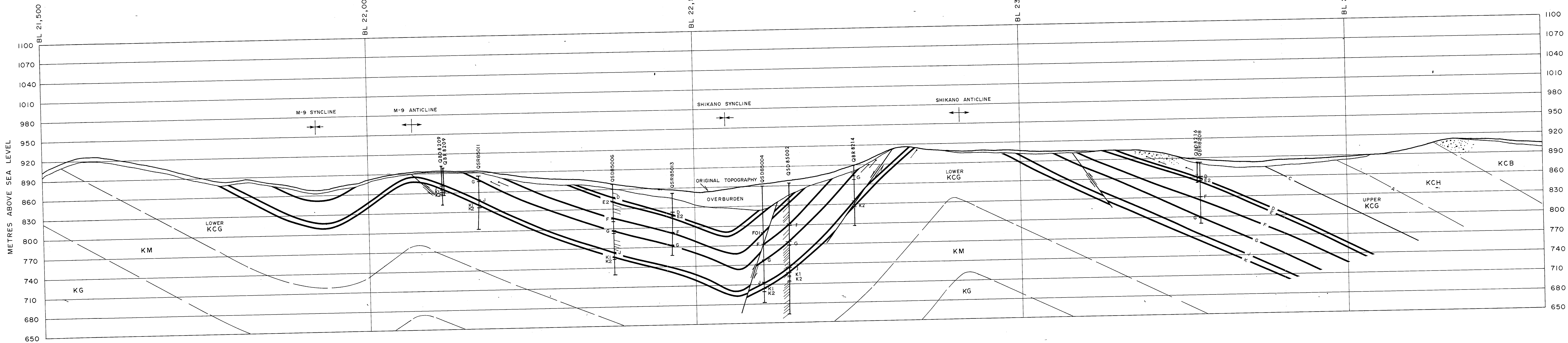

0	14	05	85	ORIGINAL DRAFT	KJV	GK	GK
Rev.	D	M	Y	Revision Description	Drn.	Des.	App.

QUINTETTE COAL LIMITED
 Project Manager
DENISON MINES LIMITED
 COAL DIVISION

Area SHIKANO Category CROSS SECTION

Drawing Title
SHIKANO
CROSS SECTION 23,800

Scale 1:2500	Drawing No. 85-300-21-011	Rev. 0
-----------------	------------------------------	-----------

S.W.

N.E.

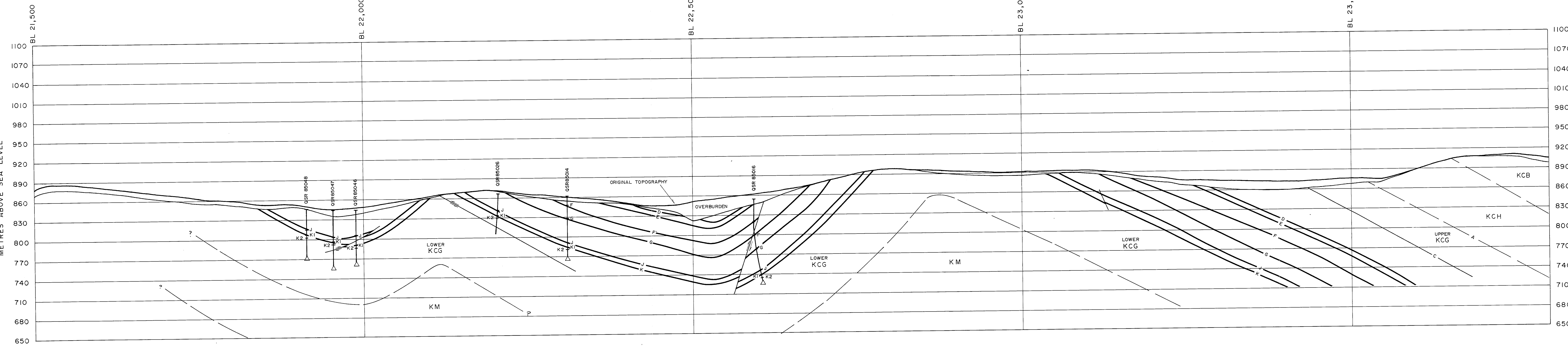

LEGEND

- DRILL HOLE LOCATION (SECTION)
- DRILL HOLE NUMBER
- DRILL HOLE
- BEDDING ANGLE IN CORE
- SEAM I.D., TOP OF SEAM
- PROJECTED APPARENT DIP IN SECTION OF OUTCROP
- TOP OF COAL SEAM
- FAULT WITH RELATIVE MOVEMENT
- FORMATION CONTACT

50 0 50 100 200 METRES

0	14	05/85	ORIGINAL DRAFT	KJV	GK	GK	
Rev.	D	M	Y	Revision Description	Drn.	Des.	App.

QUINTETTE COAL LIMITED
 Project Manager
DENISON MINES LIMITED
 COAL DIVISION

Area SHIKANO Category CROSS SECTION

Drawing Title
SHIKANO
CROSS SECTION 23,900

Scale 1:2500	Drawing No. 85 - 300 - 21 - 012	Rev. 0
-----------------	------------------------------------	-----------

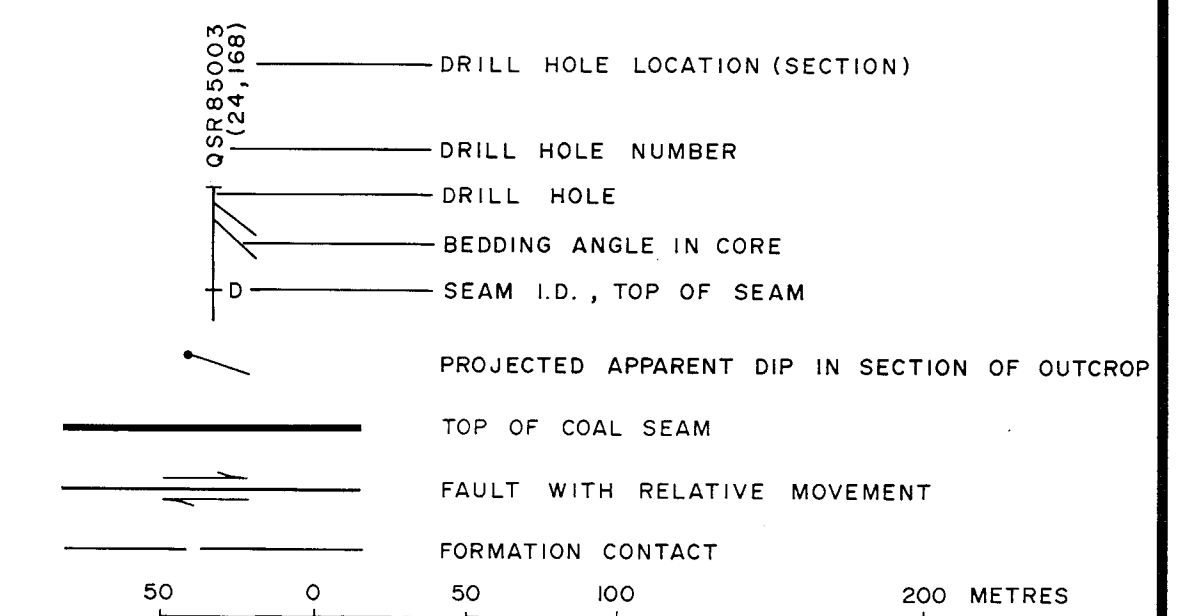
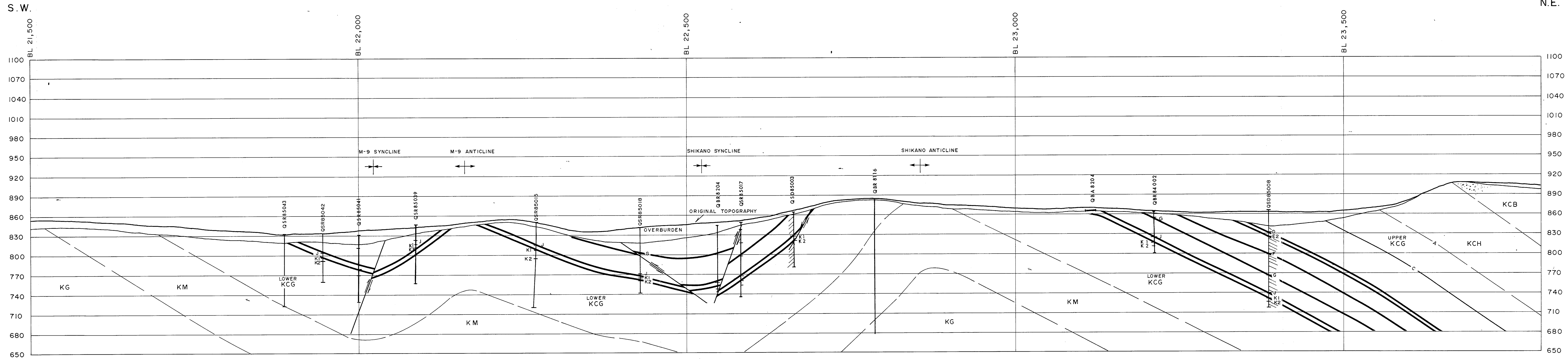

0	14	05	85	ORIGINAL DRAFT	KJV	GK	GK
Rev.	D	M	Y	Revision Description	Drn.	Des.	App.

QUINTETTE COAL LIMITED
 Project Manager
DENISON MINES LIMITED
 COAL DIVISION

Area SHIKANO Category CROSS SECTION

Drawing Title
SHIKANO
CROSS SECTION 24,000

Scale 1:2500	Drawing No. 85-300-21-013	Rev. 0
-----------------	------------------------------	-----------

S.W.

N.E.

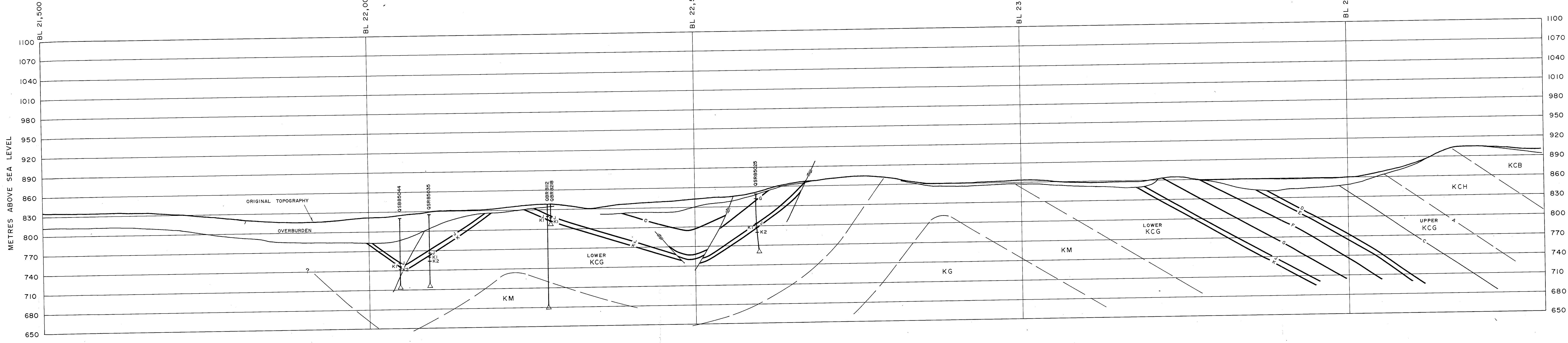

LEGEND

- DRILL HOLE LOCATION (SECTION)
- DRILL HOLE NUMBER
- DRILL HOLE
- BEDDING ANGLE IN CORE
- SEAM I.D., TOP OF SEAM
- PROJECTED APPARENT DIP IN SECTION OF OUTCROP
- TOP OF COAL SEAM
- FAULT WITH RELATIVE MOVEMENT
- FORMATION CONTACT

50 0 50 100 200 METRES

0	14	05	85	ORIGINAL DRAFT	KJV	GK	GK
Rev.	D	M	Y	Revision Description	Drn.	Des.	App.

QUINTETTE COAL LIMITED
 Project Manager
DENISON MINES LIMITED
 COAL DIVISION

Area SHIKANO Category CROSS SECTION

Drawing Title
SHIKANO
CROSS SECTION 24,100

Scale 1:2500	Drawing No. 85-300-21-014	Rev. 0
-----------------	------------------------------	-----------

S.W.

N.E.

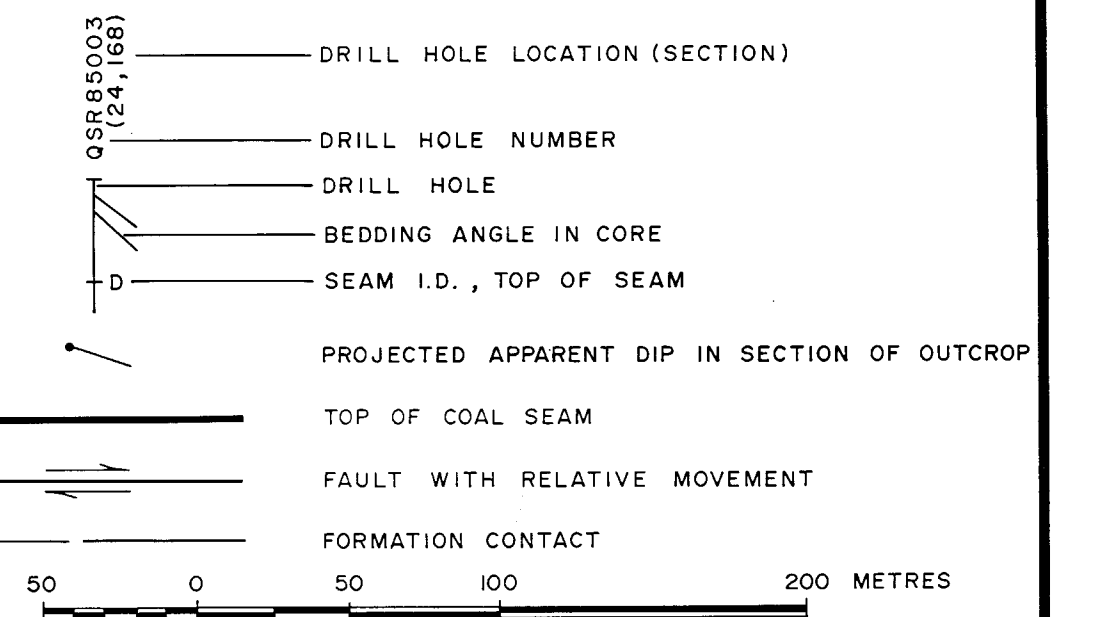
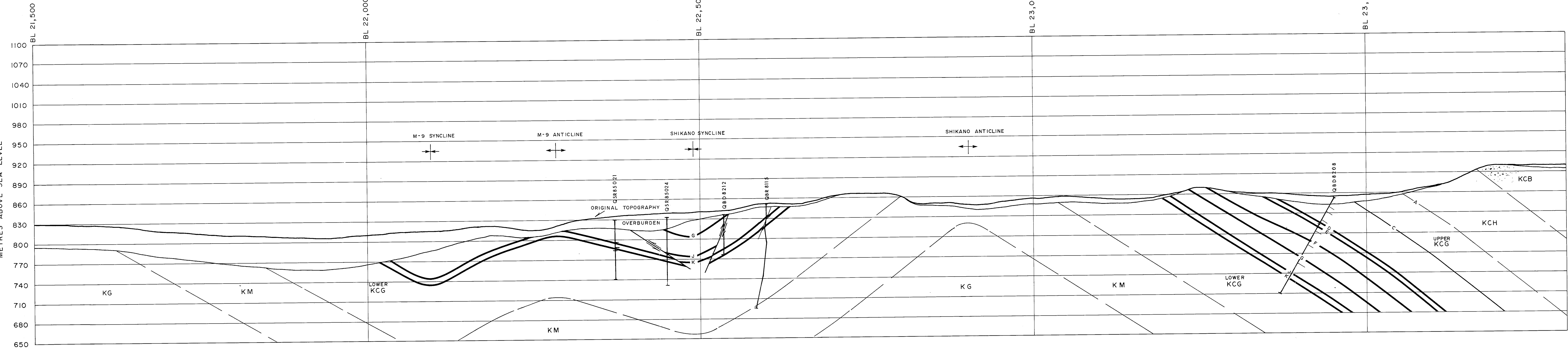

0	14	05	85	ORIGINAL DRAFT	KJV	GK	GK
Rev.	D	M	Y	Revision Description	Drn.	Des.	App.

QUINTETTE COAL LIMITED
 Project Manager
DENISON MINES LIMITED
 COAL DIVISION

Area SHIKANO Category CROSS SECTION

Drawing Title
SHIKANO
CROSS SECTION 24,200

Scale	Drawing No.	Rev.
1:2500	85-300-21-015	0

S.W.

N.E.

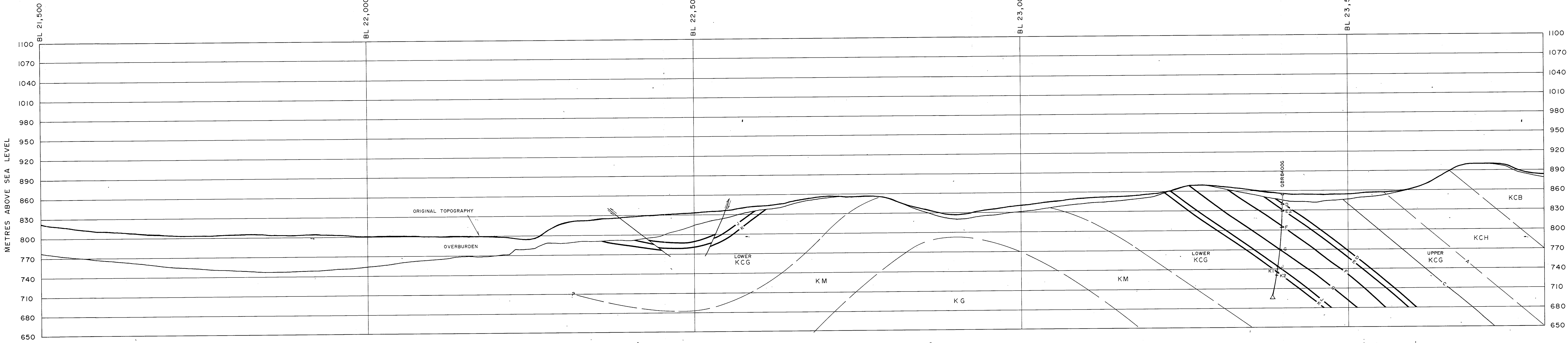

LEGEND

- DRILL HOLE LOCATION (SECTION)
- DRILL HOLE NUMBER
- DRILL HOLE
- BEDDING ANGLE IN CORE
- SEAM I.D., TOP OF SEAM
- PROJECTED APPARENT DIP IN SECTION OF OUTCROP
- TOP OF COAL SEAM
- FAULT WITH RELATIVE MOVEMENT
- FORMATION CONTACT

50 0 50 100 200 METRES

0	4	05	85	ORIGINAL DRAFT	KJV	GK	GK
Rev.	D	M	Y	Revision Description	Drn.	Des.	App.

QUINTETTE COAL LIMITED
 Project Manager
DENISON MINES LIMITED
 COAL DIVISION

Area SHIKANO Category CROSS SECTION

Drawing Title
SHIKANO
CROSS SECTION 24,300

Scale 1:2500	Drawing No. 85-300-21-016	Rev. 0
-----------------	------------------------------	-----------

S.W.

N.E.

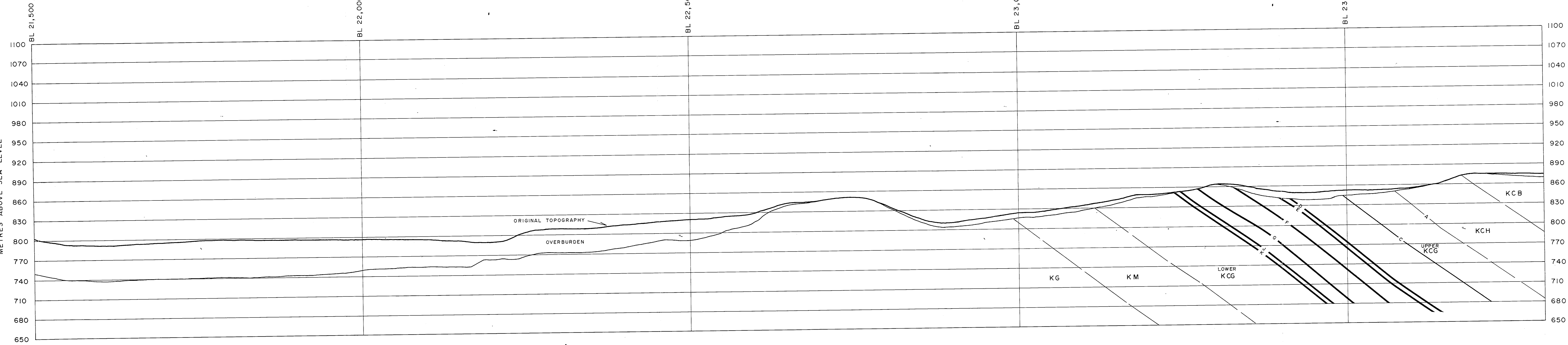

OSR85003 (24,168) — DRILL HOLE LOCATION (SECTION)
 — DRILL HOLE NUMBER
 — DRILL HOLE
 — BEDDING ANGLE IN CORE
 — SEAM I.D., TOP OF SEAM
 — PROJECTED APPARENT DIP IN SECTION OF OUTCROP
 — TOP OF COAL SEAM
 — FAULT WITH RELATIVE MOVEMENT
 — FORMATION CONTACT

50 0 50 100 200 METRES

0	14	05	85	ORIGINAL DRAFT	KJV	GK	GK
Rev.	D	M	Y	Revision Description	Drn.	Des.	App.

QUINTETTE COAL LIMITED
 Project Manager
DENISON MINES LIMITED
 COAL DIVISION

Area SHIKANO Category CROSS SECTION

Drawing Title
SHIKANO
CROSS SECTION 24,400

Scale 1:2500	Drawing No. 85-300-21-017	Rev. 0
-----------------	------------------------------	-----------

S.W.

N.E.

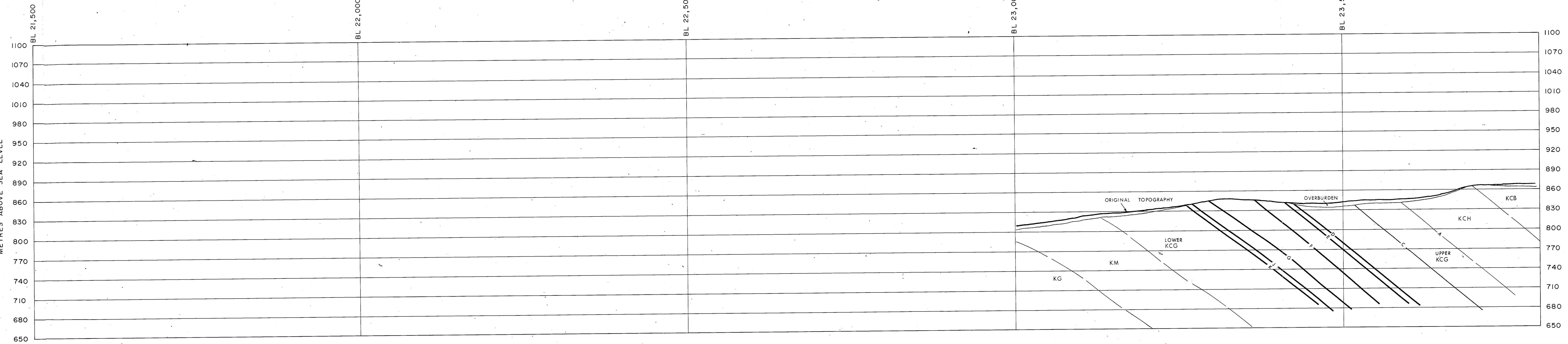

LEGEND

- DRILL HOLE LOCATION (SECTION)
- DRILL HOLE NUMBER
- DRILL HOLE
- BEDDING ANGLE IN CORE
- SEAM I.D., TOP OF SEAM
- PROJECTED APPARENT DIP IN SECTION OF OUTCROP
- TOP OF COAL SEAM
- FAULT WITH RELATIVE MOVEMENT
- FORMATION CONTACT

50 0 50 100 200 METRES

0	14	05	85	ORIGINAL DRAFT	KJV	GK	GK
Rev.	D	M	Y	Revision Description	Drn.	Des.	App.

QUINTETTE COAL LIMITED
 Project Manager
DENISON MINES LIMITED
 COAL DIVISION

Area SHIKANO Category CROSS SECTION

Drawing Title
SHIKANO 24,500
CROSS SECTION

Scale 1:2500	Drawing No. 85-300-21-018	Rev. 0
-----------------	------------------------------	-----------

S.W.

N.E.

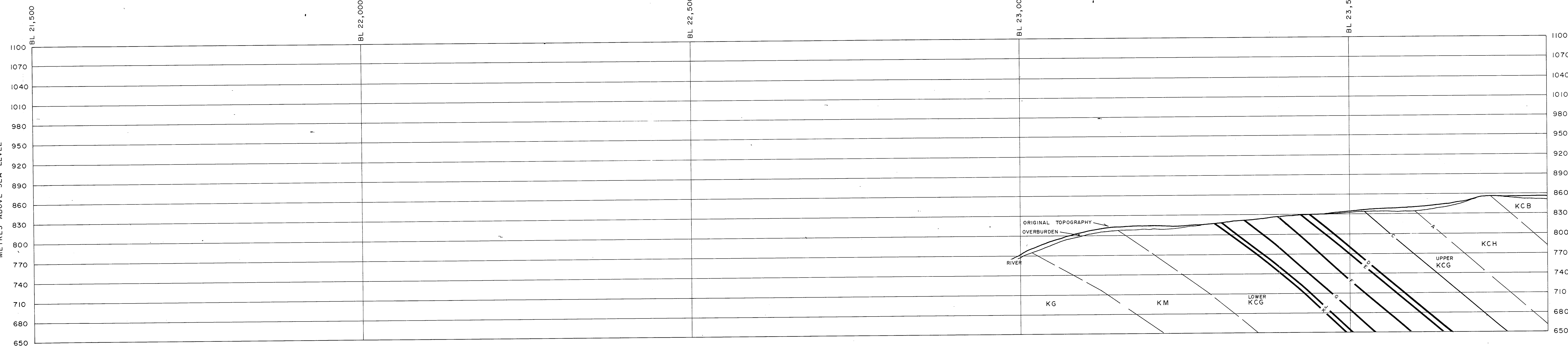

LEGEND

- DRILL HOLE LOCATION (SECTION)
- DRILL HOLE NUMBER
- DRILL HOLE
- BEDDING ANGLE IN CORE
- SEAM I.D., TOP OF SEAM
- PROJECTED APPARENT DIP IN SECTION OF OUTCROP
- TOP OF COAL SEAM
- FAULT WITH RELATIVE MOVEMENT
- FORMATION CONTACT

0 50 100 200 METRES

Rev.	D	M	Y	Revision Description	Drn.	Des.	App.
0	14	05	85	ORIGINAL DRAFT	KJV	GK	GK

QUINTETTE COAL LIMITED
 Project Manager
DENISON MINES LIMITED
 COAL DIVISION

Area **SHIKANO** Category **CROSS SECTION**

Drawing Title
SHIKANO 24,600
CROSS SECTION

Scale 1:2500	Drawing No. 85 - 300 - 21 - 019	Rev. 0
-----------------	------------------------------------	-----------

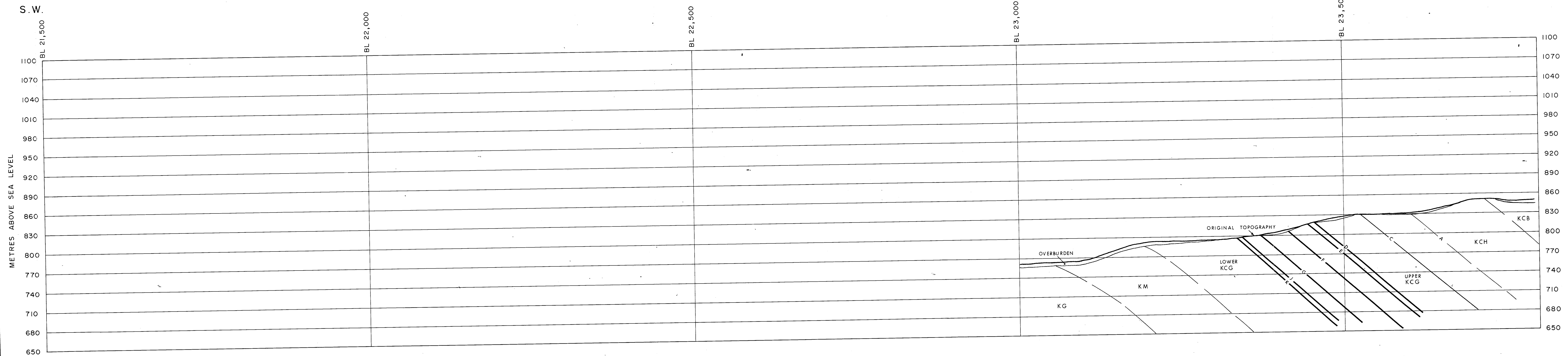

LEGEND

- DRILL HOLE LOCATION (SECTION)
- DRILL HOLE NUMBER
- DRILL HOLE
- BEDDING ANGLE IN CORE
- SEAM I.D., TOP OF SEAM
- PROJECTED APPARENT DIP IN SECTION OF OUTCROP
- TOP OF COAL SEAM
- FAULT WITH RELATIVE MOVEMENT
- FORMATION CONTACT

50 0 50 100 200 METRES

0	14	05	85	ORIGINAL DRAFT	KJV	GK	GK
Rev.	D	M	Y	Revision Description	Drn.	Des.	App.

QUINTETTE COAL LIMITED
 Project Manager
DENISON MINES LIMITED
 COAL DIVISION

Area SHIKANO Category CROSS SECTION

Drawing Title
SHIKANO 24,700
CROSS SECTION

Scale 1:2500	Drawing No. 85 - 300 - 21 - 020	Rev. 0
-----------------	------------------------------------	-----------

APPENDIX 1

Section 1.7

Adit Drawings

(5 sheets)



U.T.M. PORTAL COORDINATES
 6,094,168.8 N
 625,552.1 E
 ELEVATION
 920.8 m
 SURVEY POINT IS CENTRE OF
 PORTAL CROSSPIECE

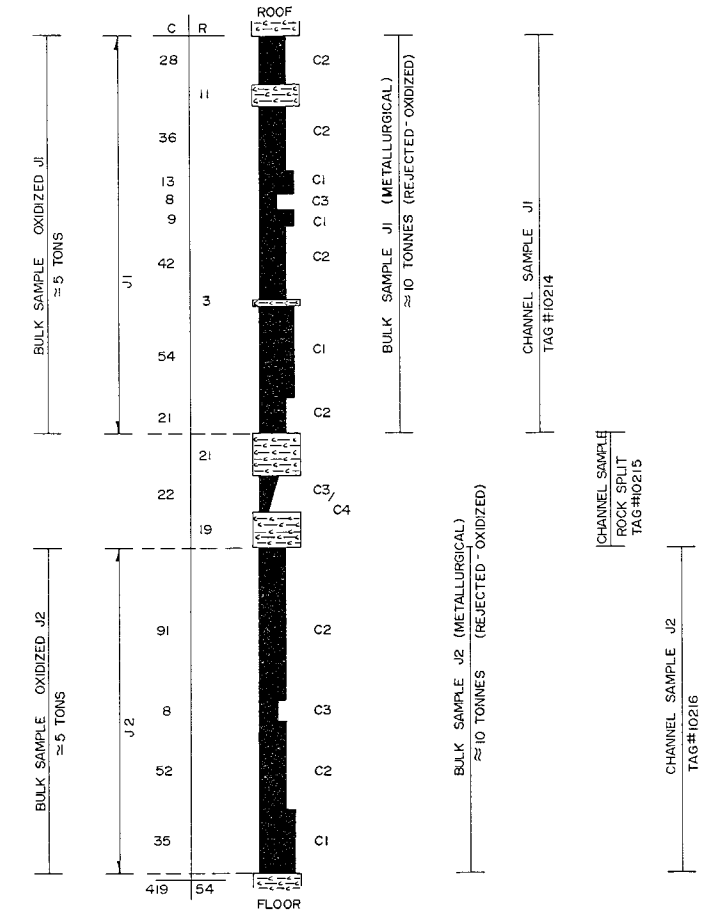
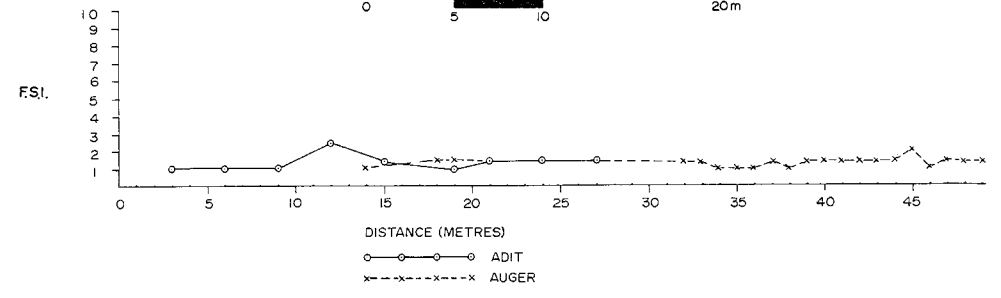
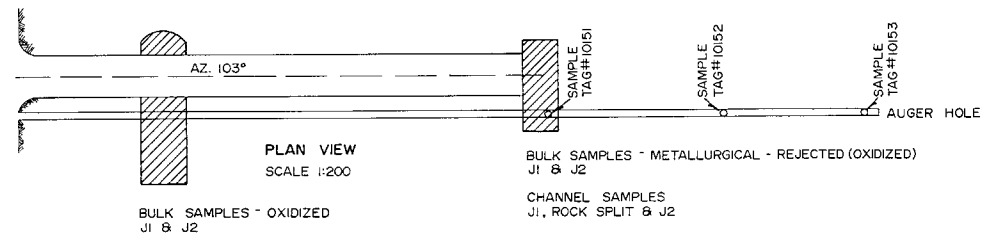
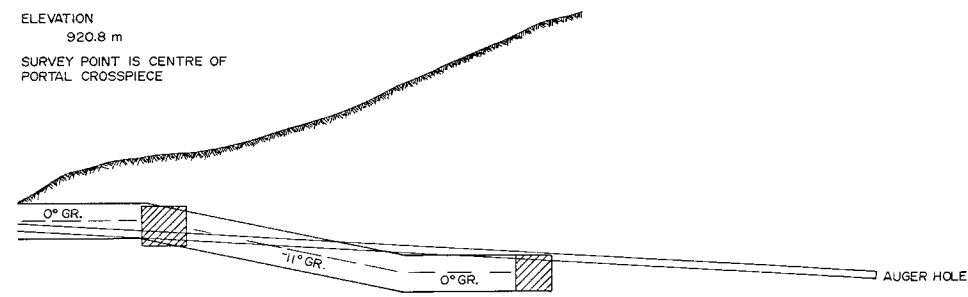

- LEGEND**
- C1 COAL 0-10% ASH
 - C2 COAL 11-20% ASH
 - C3 COAL 21-30% ASH
 - C4 COAL > 30% ASH
 - CARBONACEOUS CLAYSTONE
 - CLAYSTONE
 - TOPOGRAPHY

Rev.	D	M	Y	Revision	Description	Drn.	Des.	App.
0	15	11	82			SRT	GH	

QUINTETTE COAL LIMITED
 Project Manager
DENISON MINES LIMITED
 COAL DIVISION

Area SHIKANO Category ADITS

Drawing Title
**ADIT QBA 8201
 J SEAM**

Scale AS SHOWN	Drawing No. 82-300-25-1003	Rev. 0
-------------------	-------------------------------	-----------



U.T.M. PORTAL COORDINATES
 6,094,082.3 N
 626,449.6 E

ELEVATION
 882.4 m
 SURVEY POINT IS CENTRE OF
 PORTAL CROSSPIECE

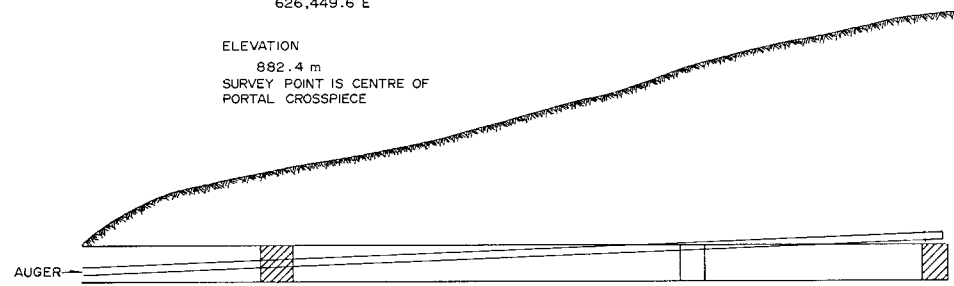

SECTION
 SCALE 1:200

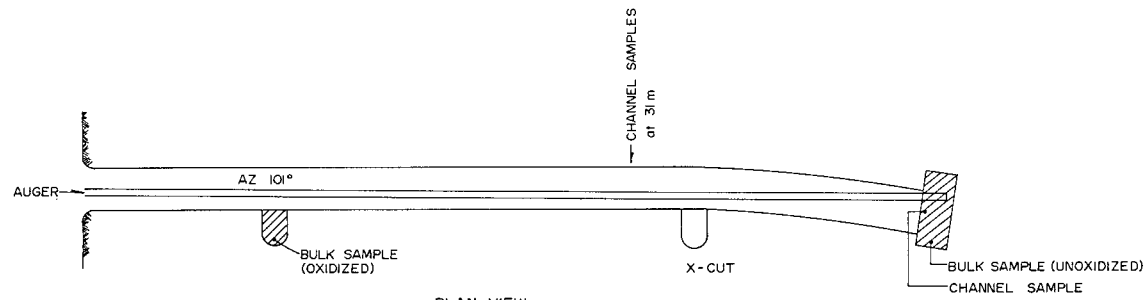

PLAN VIEW
 SCALE 1:200

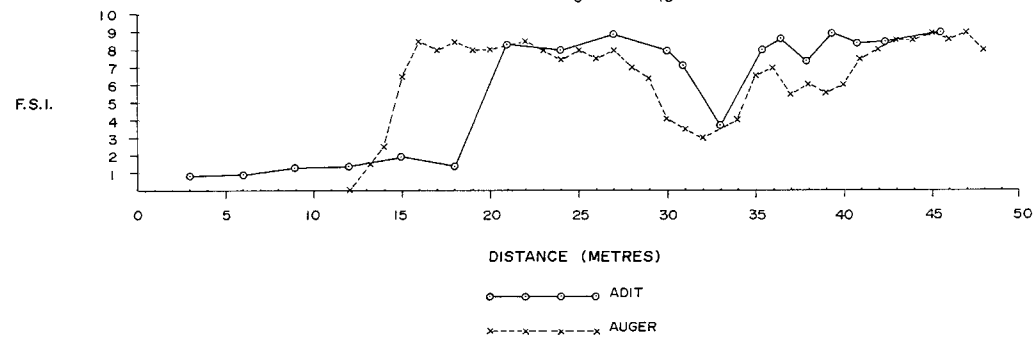

DISTANCE (METRES)

○ ○ ○ ○ ○ ADIT
 x x x x x AUGER

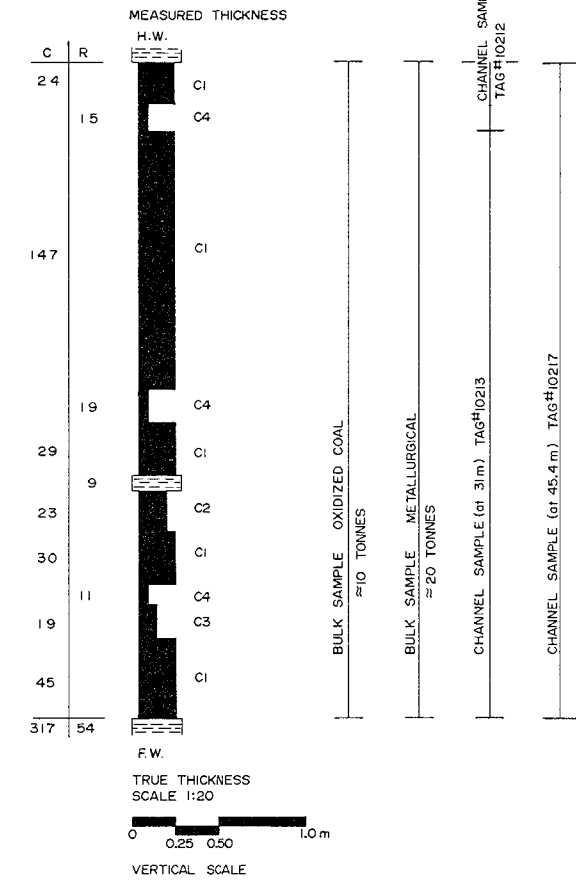

F.W.
 TRUE THICKNESS
 SCALE 1:20
 0 0.25 0.50 1.0 m
 VERTICAL SCALE

- C1 COAL 0 - 10% ASH
 - C2 COAL 11 - 20% ASH
 - C3 COAL 21 - 30% ASH
 - C4 COAL > 31% ASH
- } BASED ON VISUAL ESTIMATES
- CLAYSTONE
 - TOPOGRAPHY

--	--	--	--	--	--	--	--	--	--

0	17	11	82	SRT	GH
Rev.	D	M	Y	Revision	Description

QUINETTE COAL LIMITED
 Project Manager
DENISON MINES LIMITED
 COAL DIVISION

Area SHIKANO Category ADITS

Drawing Title
ADIT QBA 8202
F SEAM

Scale AS SHOWN	Drawing No. 82-300-25-1002	Rev. 0
-------------------	-------------------------------	-----------

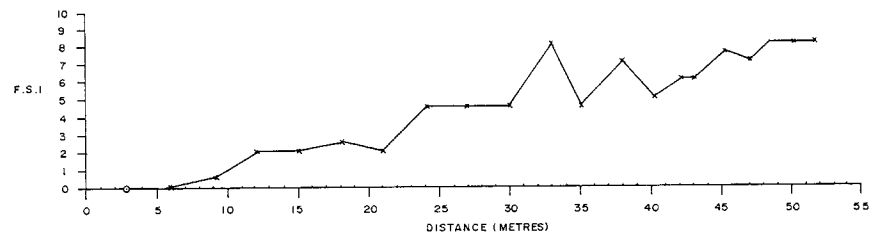

FACE SECTION A-B

U.T.M. PORTAL COORDINATES
 6,093,742.38 N
 625,947.06 E
 ELEVATION
 FLOOR 850.74
 ROOF 852.75

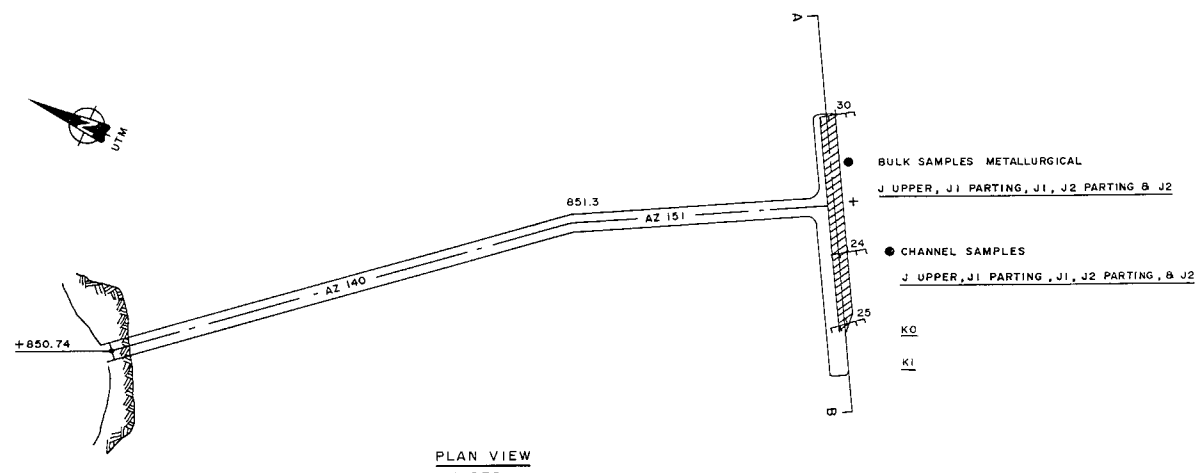

PLAN VIEW
 1:250

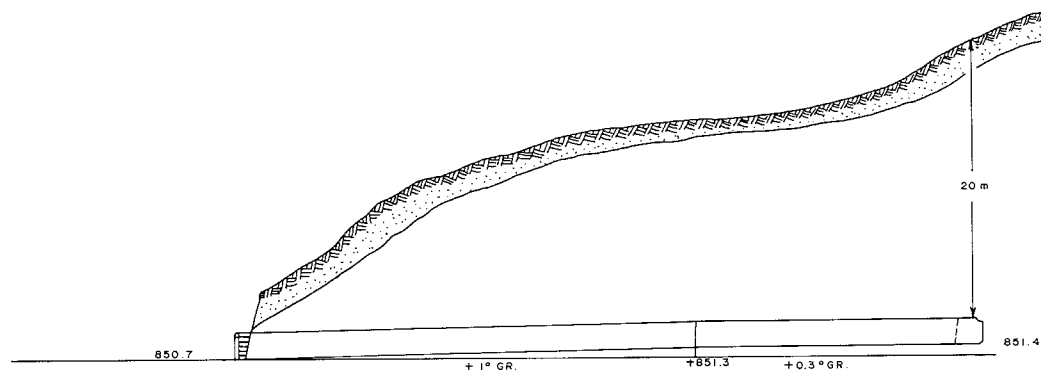

SECTION
 1:250

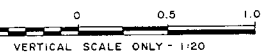
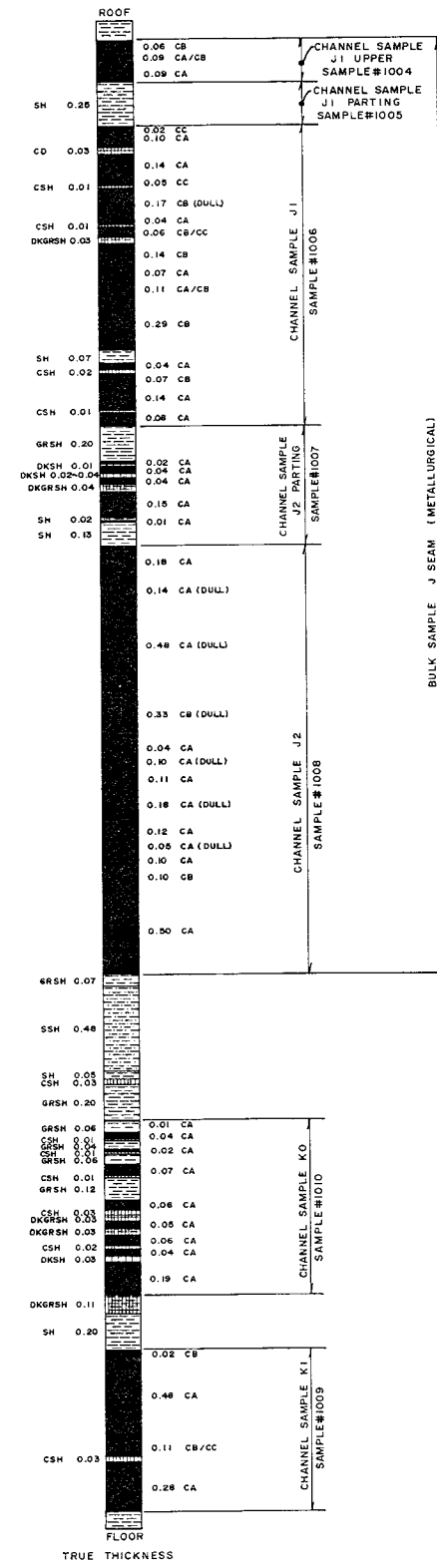
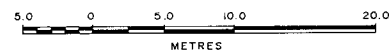

LEGEND

- SHALE
- SANDY SHALE (SILTSTONE)
- COALY SHALE
- GREY SHALE
- DARK SHALE
- DARK GREY SHALE
- CA COAL 0-10% ASH
- CB COAL 11-20% ASH
- CC COAL 21-30% ASH
- CD COAL >30% ASH
- TOPOGRAPHY

0	16	05	85	ORIGINAL DRAFT	KJV	IK	IK
Rev.	D	M	Y	Revision Description	Drn.	Des.	App.

QUINTETTE COAL LIMITED
 Project Manager
DENISON MINES LIMITED
 COAL DIVISION

Area SHIKANO Category ADITS

Drawing Title
SHIKANO
ADIT QSA 850I
J & K SEAMS

Scale	Drawing No.	Rev.
AS SHOWN	85-300-25-001	0

APPENDIX 1

Section 1.8

Geophysical Log Correlation

(1:200)

GEOPHYSICAL LOG CORRELATION

SHEETS 1 THROUGH 20

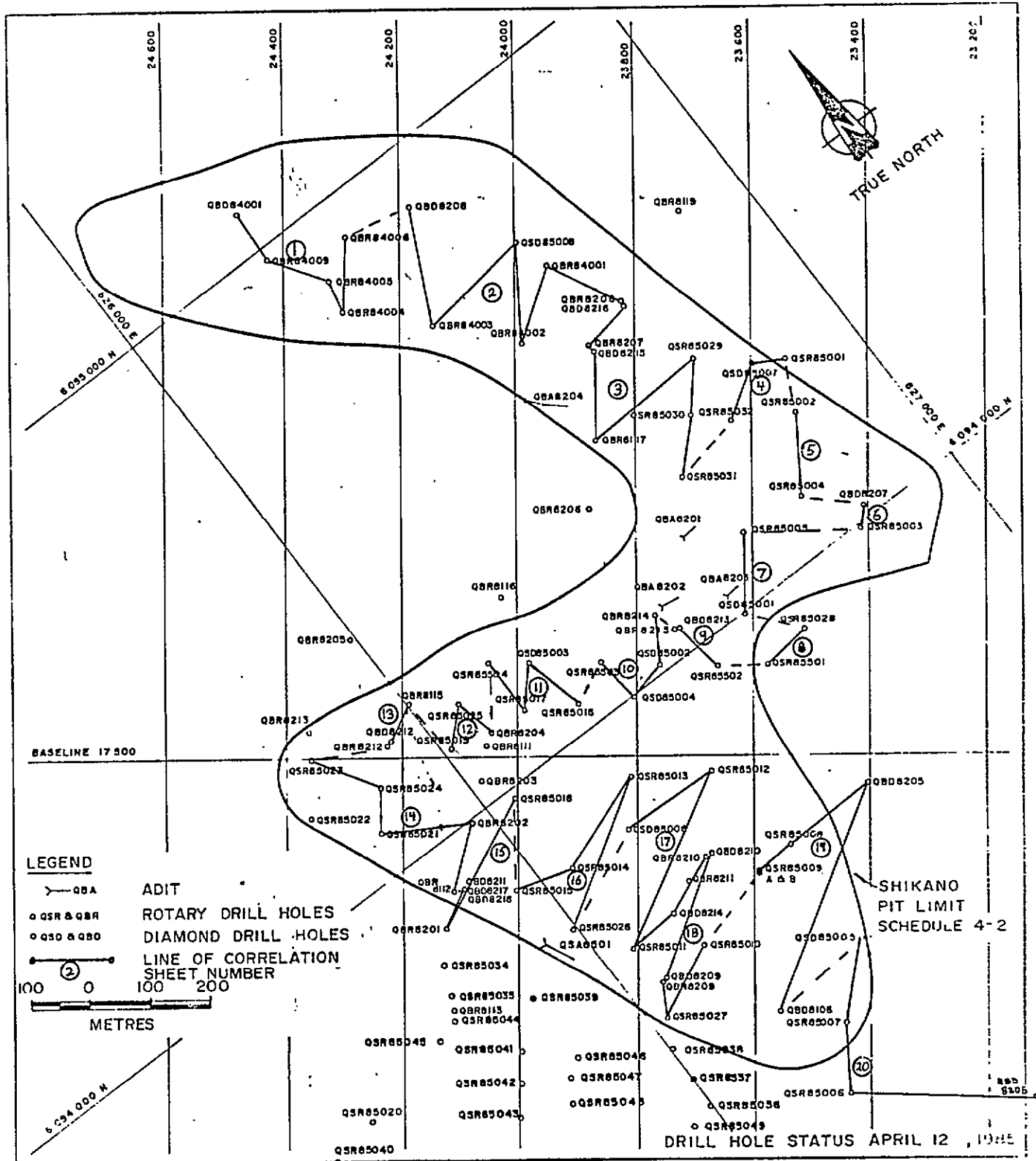

SHIKANO DRILL HOLE STATUS

QBD 84001

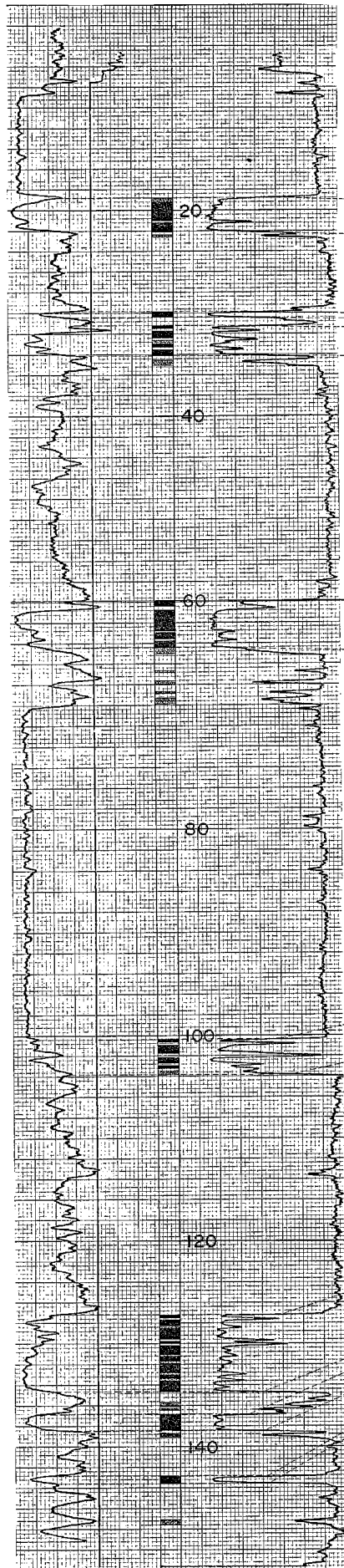

QBR 84009

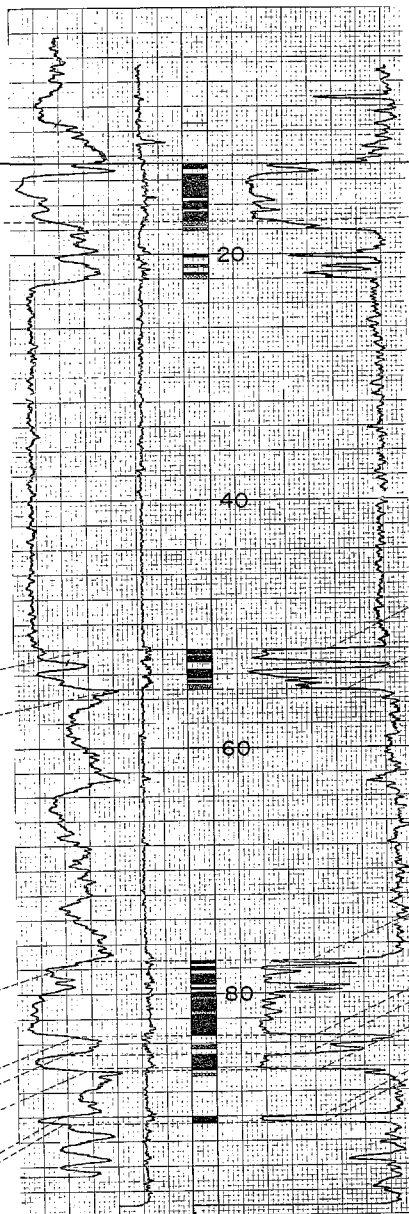

QBR 84005

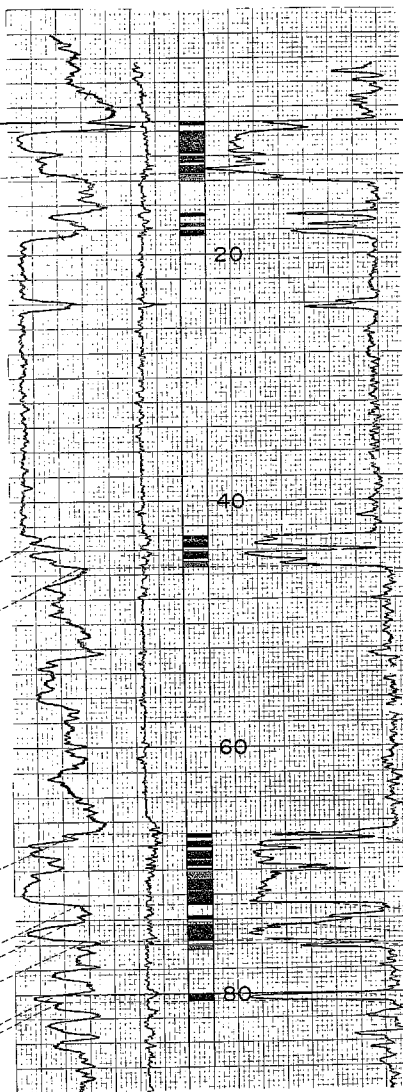

QBR 84004

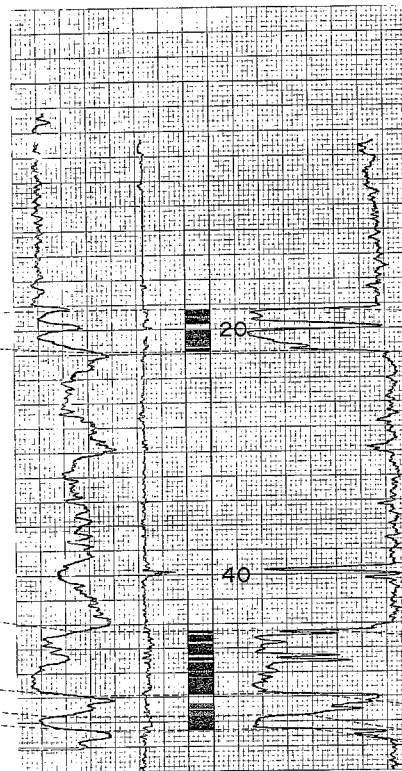

QBR 84006

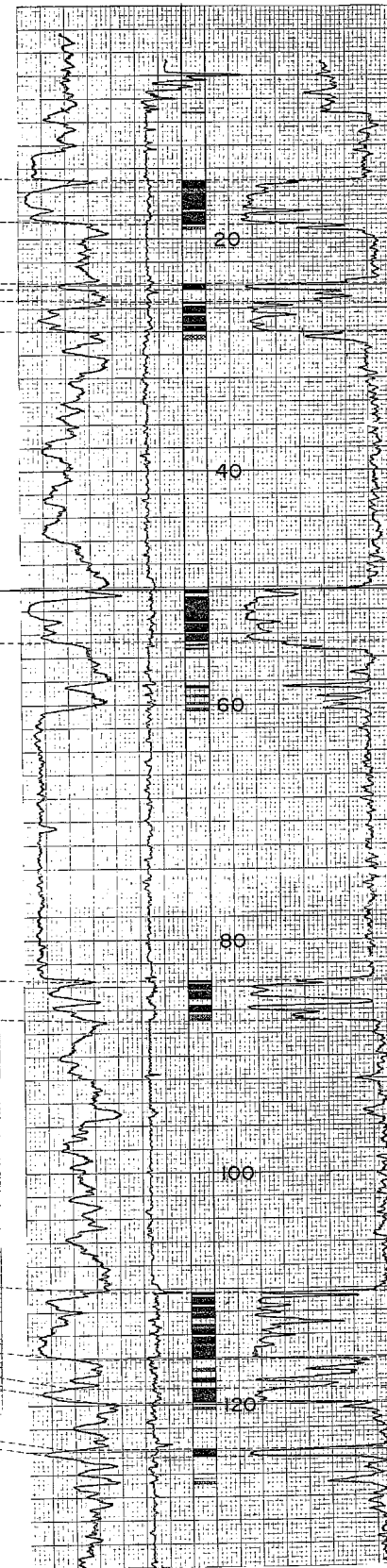

D SEAM
 E1 SEAM
 E2 SEAM
 DATUM
 F SEAM
 G SEAM
 J SEAM
 K1 SEAM
 K2 SEAM

KEY MAP

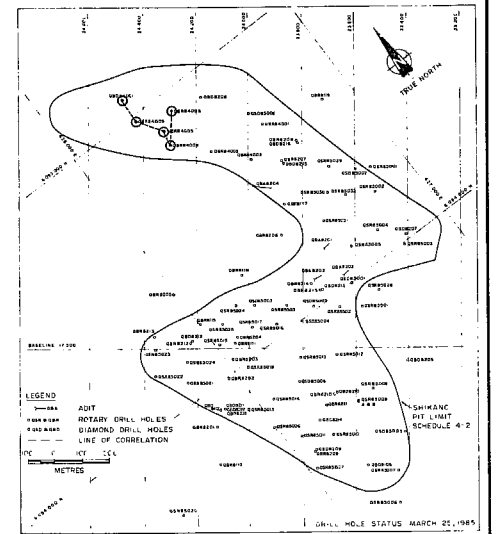

LEGEND

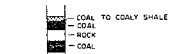

GEOPHYSICAL LOGS

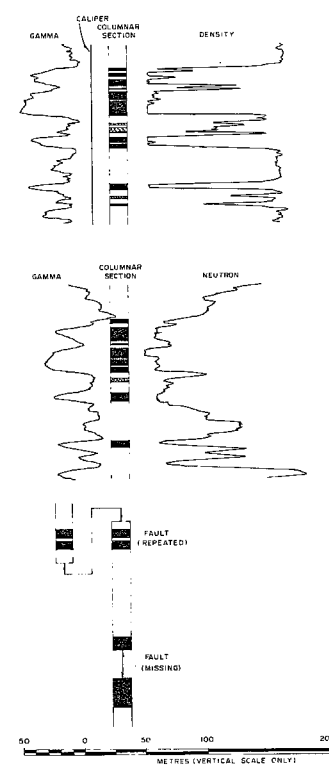

NOTE 1) ALL THICKNESSES ARE APPARENT
 2) ADDITIONAL DENSIMETER GEOPHYSICAL DATA IS AVAILABLE FOR MOST HOLES
 3) GAMMA/NEUTRON LOGS USED ONLY WHEN DENSITY LOG IS NOT AVAILABLE

0	01/05/05	ORIGINAL DRAFT	K.T.J.	K.T.J.	K.T.J.
Rev	D	M	Y	Revision/Description	Drn. Des. App.
QUINTETTE COAL LIMITED					
Project Manager DENISON MINES LIMITED					
COAL DIVISION					
Area	SHIKANO		Category CORRELATION		
Drawing Title					
SHIKANO					
DRILL HOLE GEOPHYSICAL LOG					
CORRELATION OF COAL-BEARING					
SECTION					
SHEET <u>1</u> of 20					
Scale	Drawing No.		Rev.		
1:200(VERT.)	85-300-26-001		0		
HORIZONTAL, NOT TO SCALE					

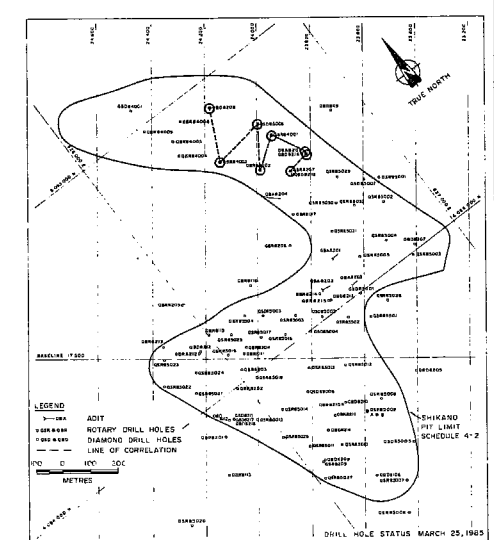

QBD 8208

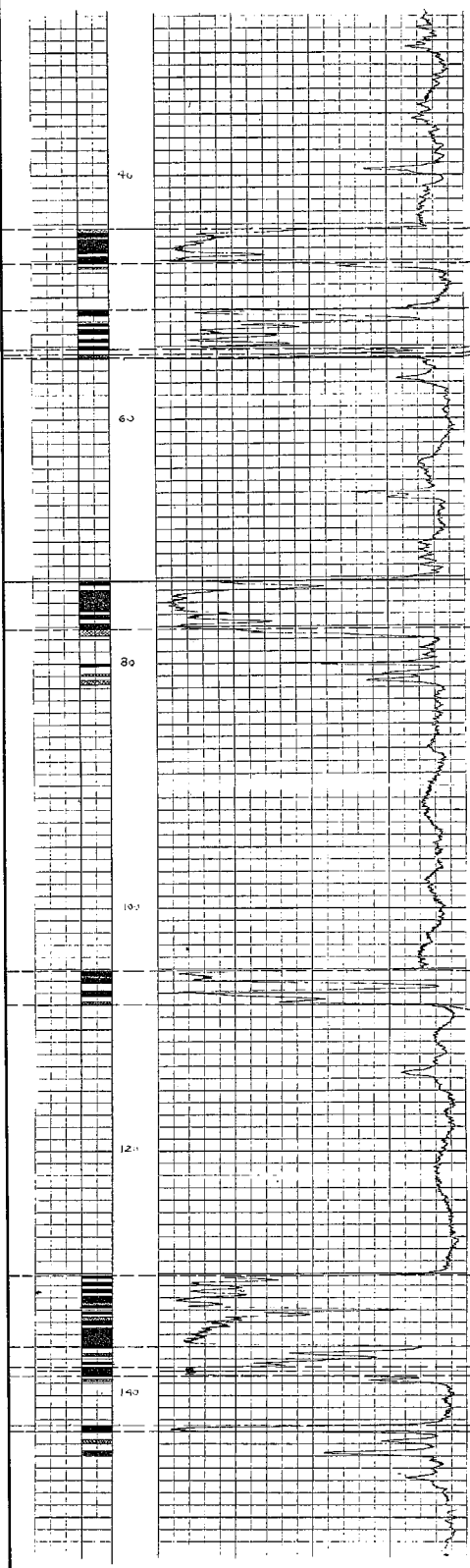

QSD 85008

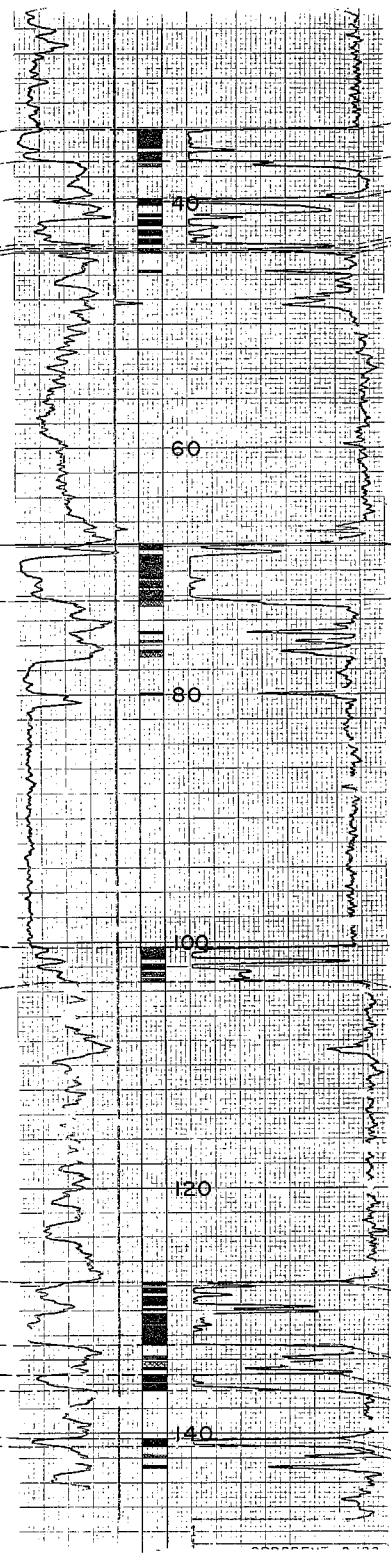

QBR 84001

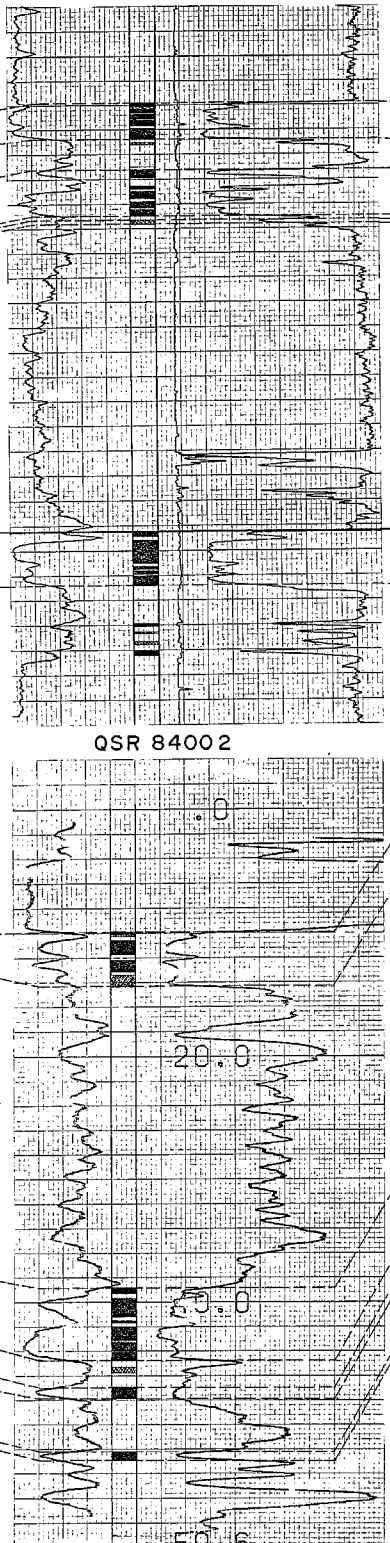

QBD 8216

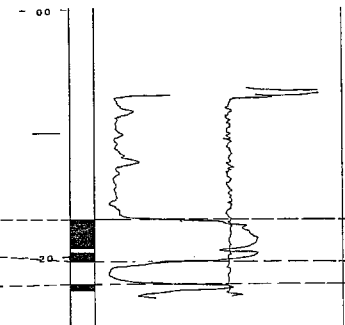

D SEAM
E SEAM
E3 SEAM

QBR 8207

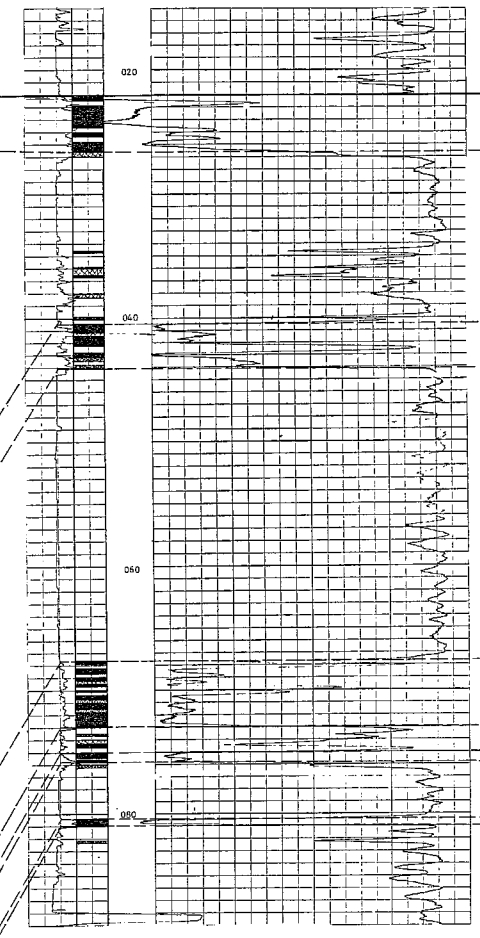

DATUM
F SEAM
G SEAM
J SEAM
K1 SEAM
K2 SEAM

QBR 84003

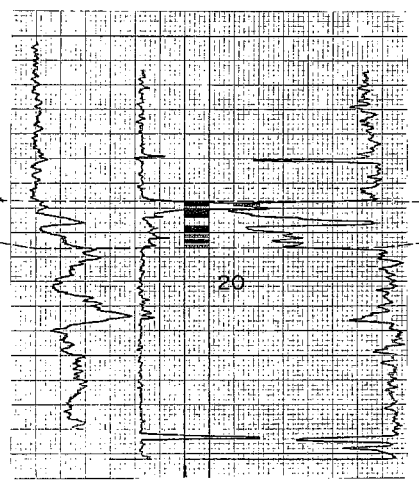

QSR 84002

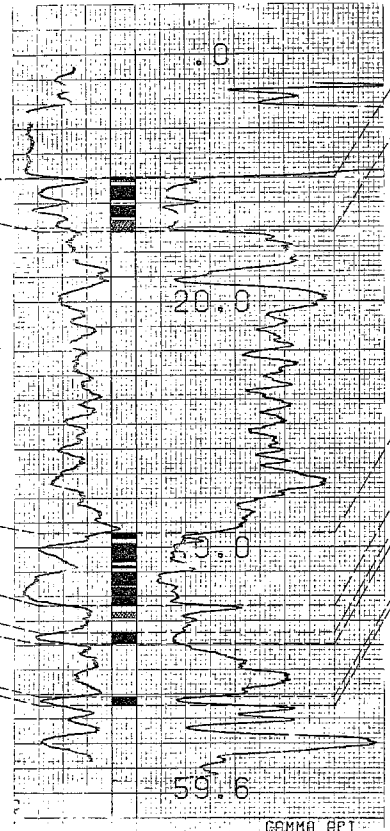

LEGEND

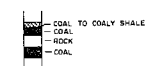

GEOPHYSICAL LOGS
1:200 SCALE

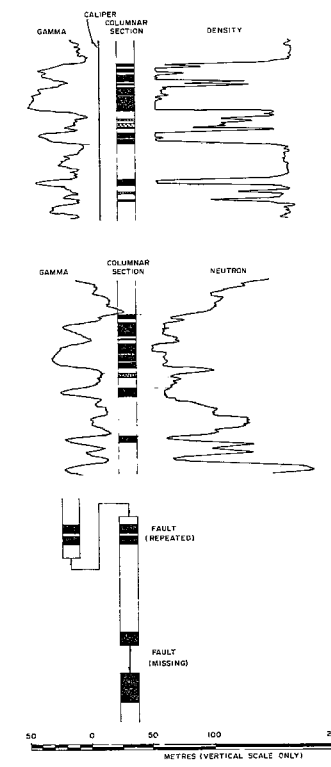

NOTE 1) ALL THICKNESSES ARE APPARENT
2) ADDITIONAL BOREHOLE GEOPHYSICAL DATA IS AVAILABLE FOR MOST HOLES
3) GAMMA/NEUTRON LOGS USED ONLY WHEN DENSITY LOG IS NOT AVAILABLE

Rev.	Dim.	Y	Revision Description	Drn.	Des.	App.
0			ORIGINAL DRAFT	KTJ	KTJ	KTJ

QUINTETTE COAL LIMITED
Project Manager
DENISON MINES LIMITED
COAL DIVISION

Area: SHIKANO Category: CORRELATION

Drawing Title
SHIKANO
DRILL HOLE GEOPHYSICAL LOG
CORRELATION OF COAL-BEARING
SECTION

SHEET 2 of 20

Scale: 1:200(VERT)
Drawing No.: 85-300-26-002
Rev. No.: 0

GAMMA API

KEY MAP

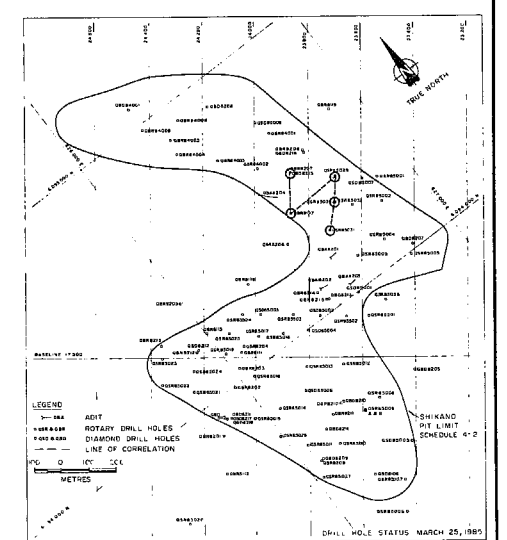

QSR 85029

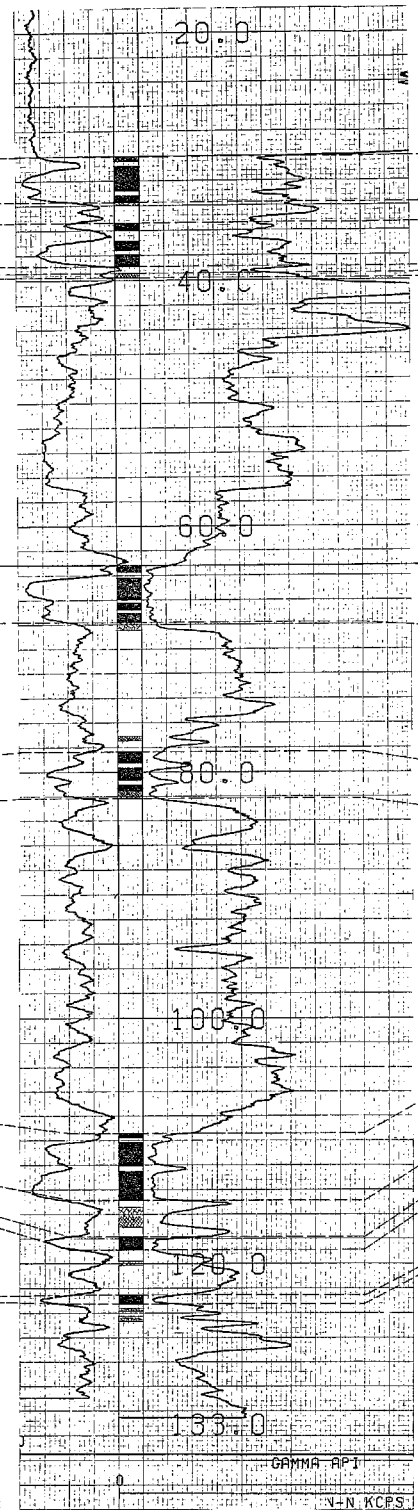

D SEAM

E SEAM QSR 85030
E3 SEAM

F SEAM

QSR 85031

G SEAM

J SEAM

KI SEAM

K2 SEAM

DATUM

QBD 8215

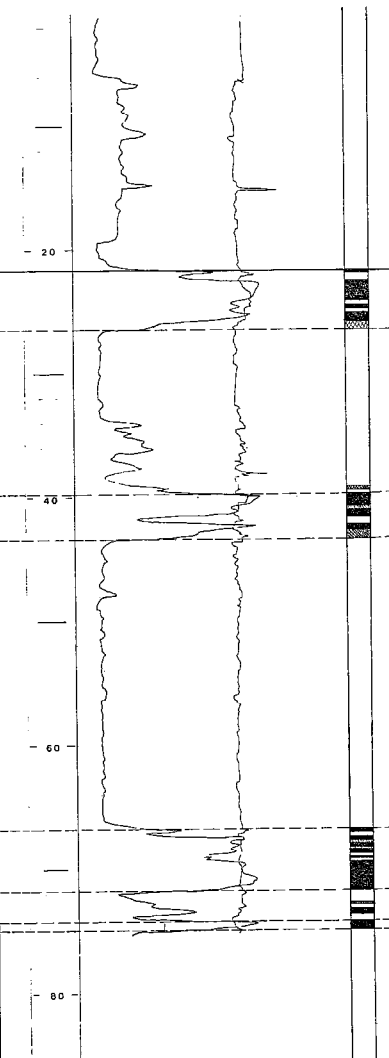

QBR 8117

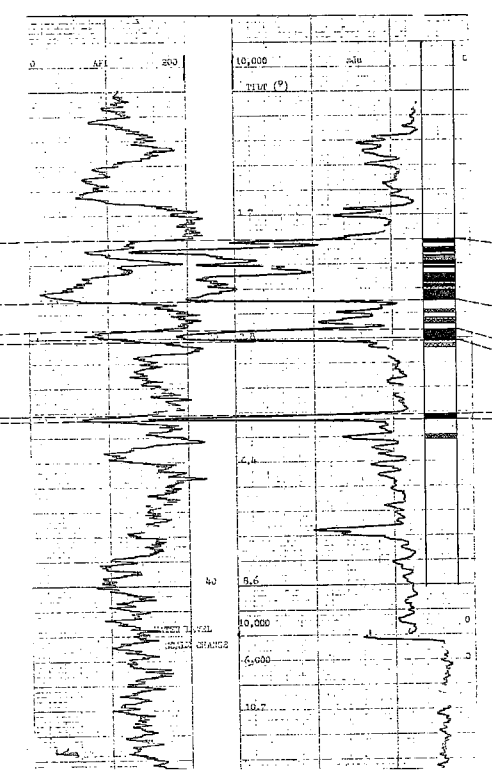

LEGEND

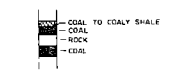

GEOPHYSICAL LOGS
1:200 SCALE

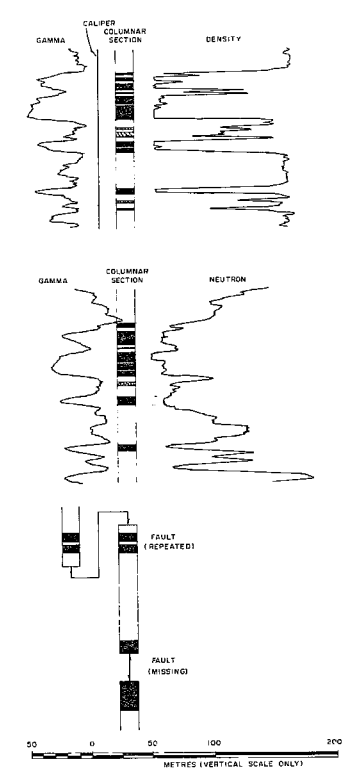

NOTE 1) ALL THICKNESSES ARE APPARENT
2) ADDITIONAL BOREHOLE GEOPHYSICAL DATA IS AVAILABLE FOR MOST HOLES
3) GAMMA/NEUTRON LOGS USED ONLY WHEN DENSITY LOG IS NOT AVAILABLE

Rev.	D	M	Y	Revision Description	Drn.	Des.	App.
0				ORIGINAL DRAFT	KTJ	KTJ	KTJ

QUINTETTE COAL LIMITED
DENISON MINES LIMITED
 COAL DIVISION

Area: SHIKANO Category: CORRELATION

Drawing Title:
SHIKANO
 DRILL HOLE GEOPHYSICAL LOG
 CORRELATION OF COAL - BEARING
 SECTION

SHEET 3 of 20

Scale	Drawing No.	Rev.
1:200(VERT.) HORIZONTAL NOT TO SCALE	85-300-26-003	0

KEY MAP

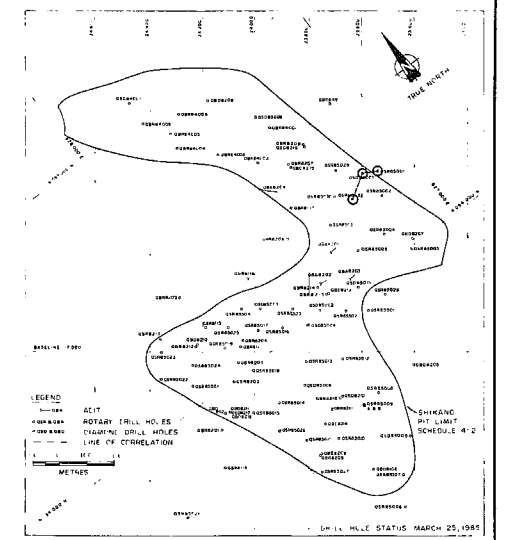

QSD 85007

QSR 85001

QSR 85032

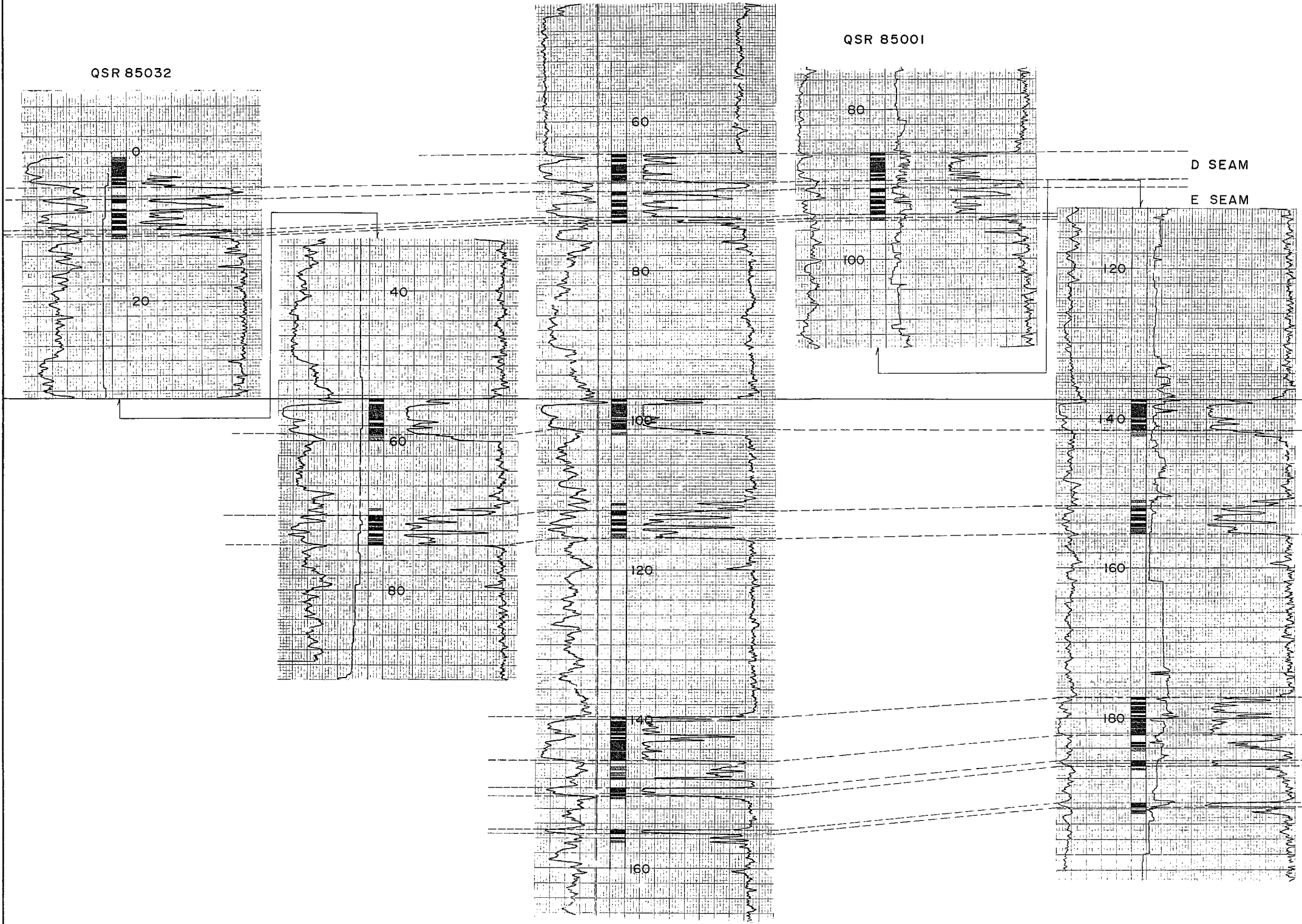

LEGEND

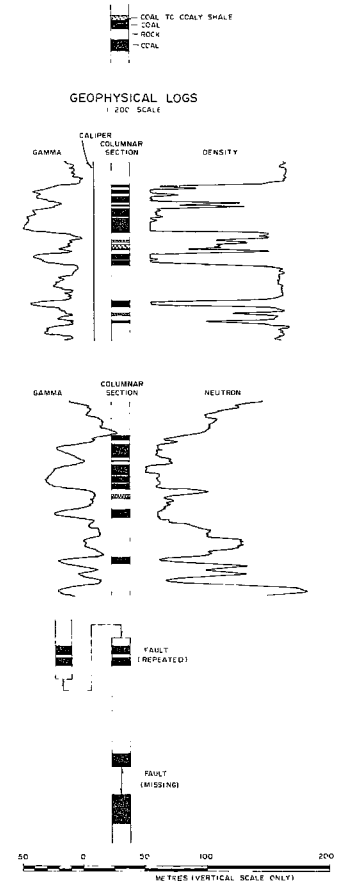

NOTE: 1) ALL THICKNESSES ARE APPARENT
 2) ADDITIONAL SOMEHOLE GEOPHYSICAL DATA IS AVAILABLE FOR MOST HOLES
 3) GAMMA/NEUTRON LOSS USED ONLY WHEN DENSITY LOG IS NOT AVAILABLE

Rev	Q.C.L. FILE NO.	ORIGINAL FILE	NTJ	NTJ	NTJ
01					
02					
03					
04					
05					
06					
07					
08					
09					
10					

QUINTETTE COAL LIMITED
 Project Manager
DENISON MINES LIMITED
 COAL DIVISION

Area: SHIKANO Category: CORRELATION

Drawing Title
SHIKANO
 DRILL HOLE GEOPHYSICAL LOG
 CORRELATION OF COAL-BEARING
 SECTION

Scale: 1:200 (VERT.) Drawing No: 85-300-26-004 SHEET 4 of 20 Rev: 0

QSR 85002

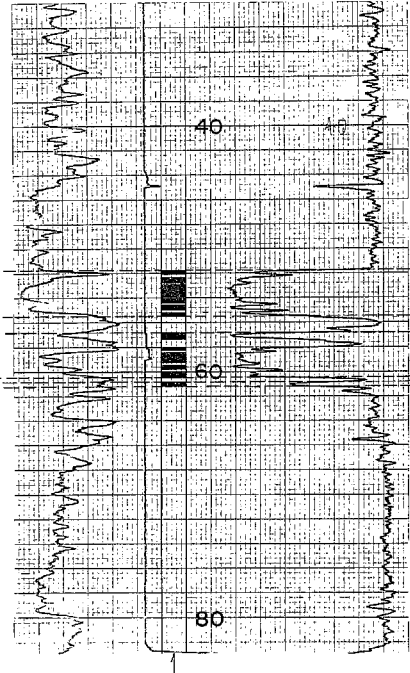

QSR 85004

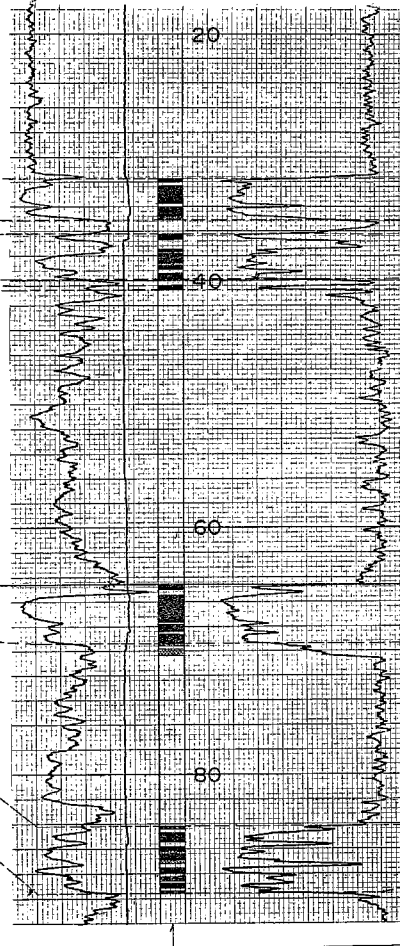

D SEAM
E SEAM
E3 SEAM

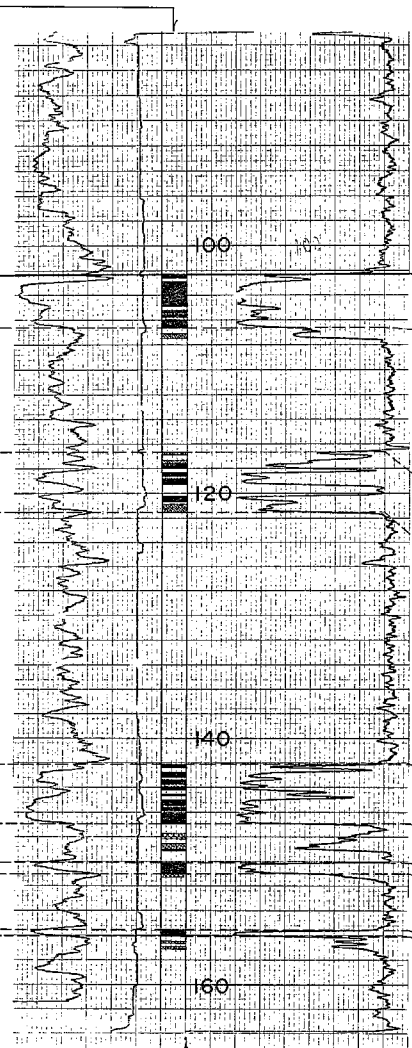

F SEAM

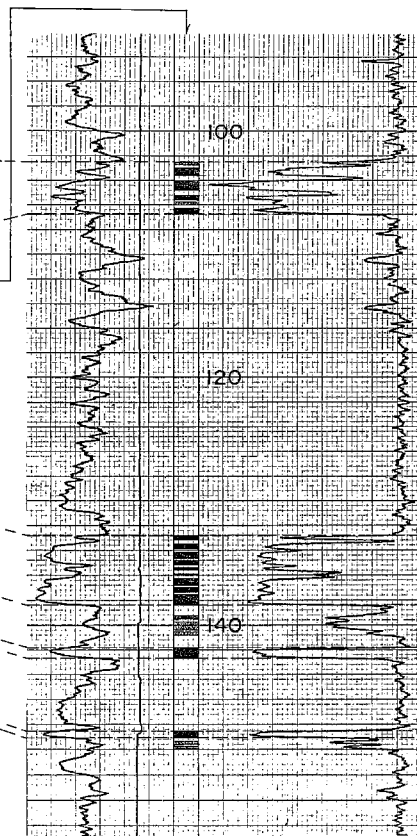

G SEAM
J SEAM
K1 SEAM
K2 SEAM

DATUM

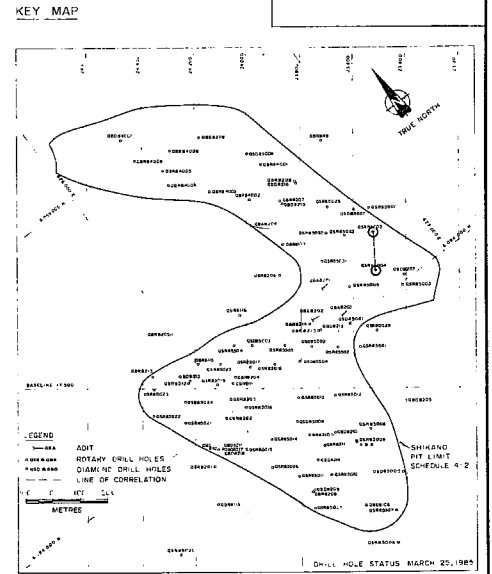

LEGEND

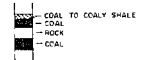

GEOPHYSICAL LOSS
1:200 SCALE

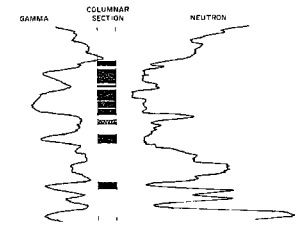
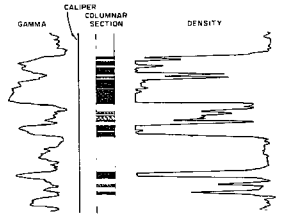

FAULT (REPEATED)

FAULT (MISSING)

50 0 50 100 200
METRES (VERTICAL SCALE ONLY)

NOTE 1) ALL THICKNESSES ARE APPARENT
2) ADDITIONAL BOREHOLE GEOPHYSICAL DATA IS AVAILABLE FOR MOST HOLES
3) GAMMA/NEUTRON LOSS USED ONLY WHEN DENSITY LOG IS NOT AVAILABLE

C	010/500	ORIGINAL DRAFT	KTJ	KTJ	KTJ
Rev.	D	MY	Revision Description	Dn.	Des. App.

QUINETTE COAL LIMITED
DENISON MINES LIMITED
 COAL DIVISION

Area	SHIKANO	Category	CORRELATION
Drawing Title			
SHIKANO DRILL HOLE GEOPHYSICAL LOG CORRELATION OF COAL-BEARING SECTION			
Scale	Drawing No	Rev	
1:200(VERT) (HORIZONTAL NOT TO SCALE)	85-300-26-005	0	

SHEET 5 of 20

KEY MAP

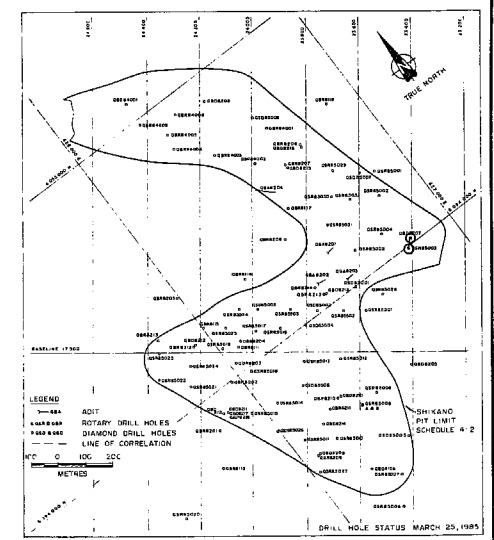

QBD 8207

QSR 85003

D SEAM

E SEAM

E3 SEAM

DATUM

F SEAM

G SEAM

J SEAM

K1 SEAM

K2 SEAM

LEGEND

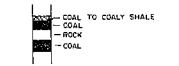

GEOPHYSICAL LOGS

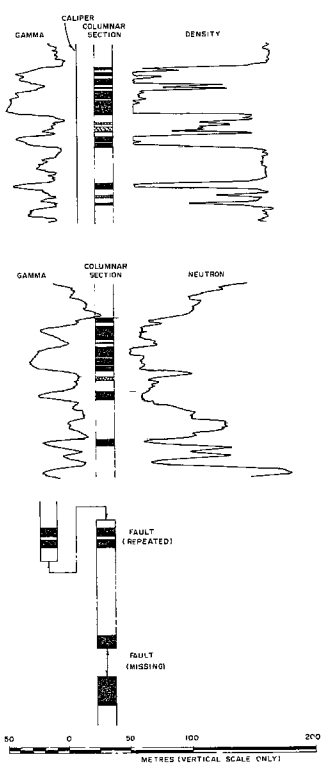

NOTE 1) ALL THICKNESSES ARE APPARENT
 2) SOMETIMES SPORECKLE GEOPHYSICAL DATA IS AVAILABLE FOR MOST HOLES
 3) GAMMA/NEUTRON LOGS USED ONLY WHEN DENSITY LOG IS NOT AVAILABLE

0	01/05/85	ORIGINAL DRAFT	KTJ	KTJ	KTJ	
Rev.	D	M	Y	Drn.	Des.	App.

QUINTETTE COAL LIMITED
 Project Manager
DENISON MINES LIMITED
 COAL DIVISION

Area: SHIKANO Category: CORRELATION

Drawing Title:
SHIKANO
DRILL HOLE GEOPHYSICAL LOG
CORRELATION OF COAL-BEARING
SECTION

Scale: 1:200 (VERT.) Drawing No.: 85-300-26-006 Rev.: 0

HORIZONTAL, NOT TO SCALE

SHEET 8 of 20

KEY MAP

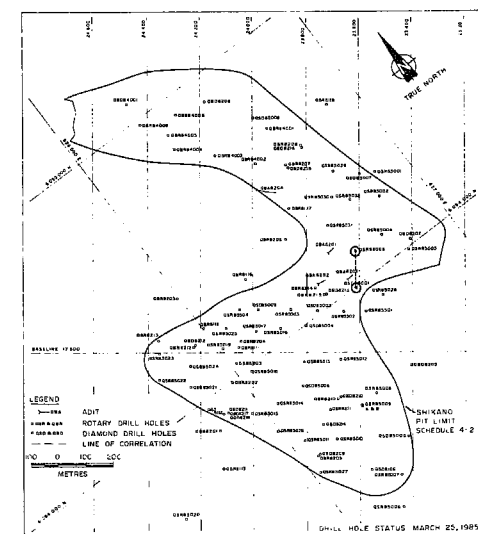

QSD 85001

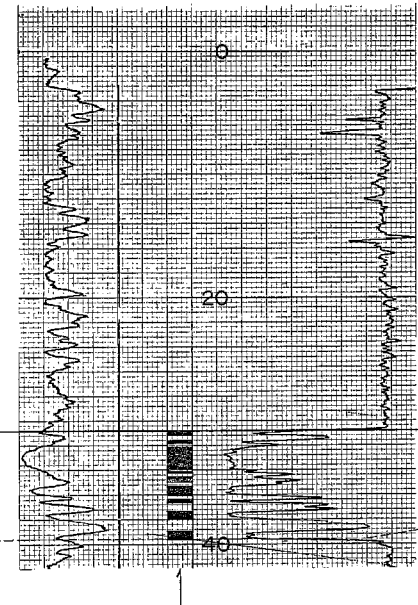

QSR 85005

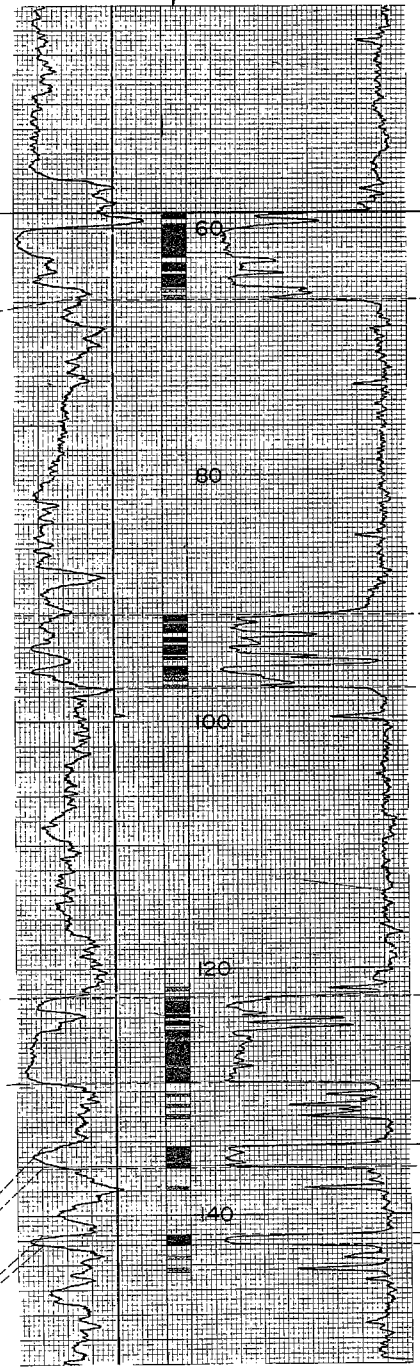
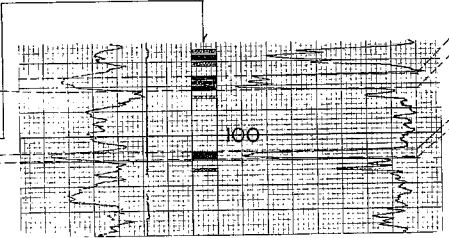
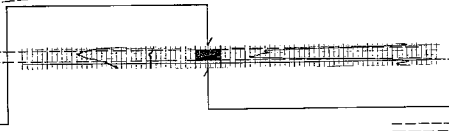
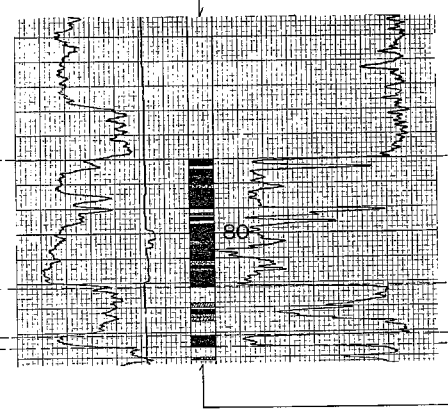
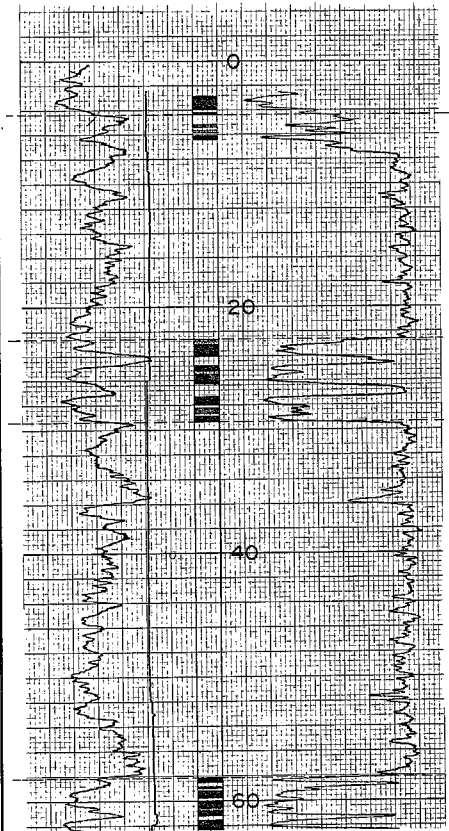

LEGEND

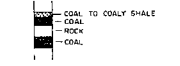

GEOPHYSICAL LOGS

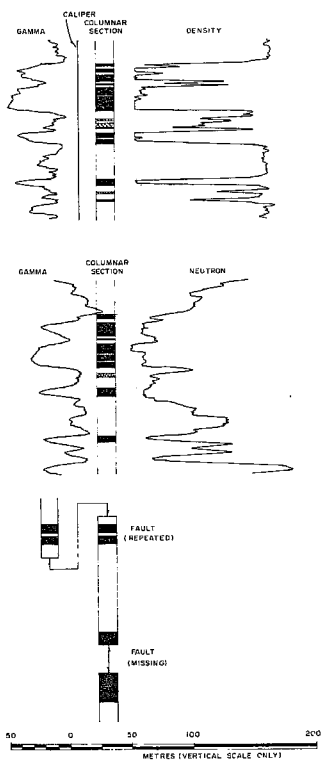

Rev	D	M	Y	Revision Description	Dra.	Des.	App.
0	18	05	05	ORIGINAL DRAFT	GMc	KTJ	KTJ

QUINTETTE COAL LIMITED
Project Manager
DENISON MINES LIMITED
COAL DIVISION

Area: SHIKANO Category: CORRELATION

Drawing Title:
SHIKANO
DRILL HOLE GEOPHYSICAL LOG
CORRELATION OF COAL-BEARING
SECTION

Scale: 1:200 (VERT.) Drawing No: 85-300-26-007 SHEET 7 of 20 Rev: 0

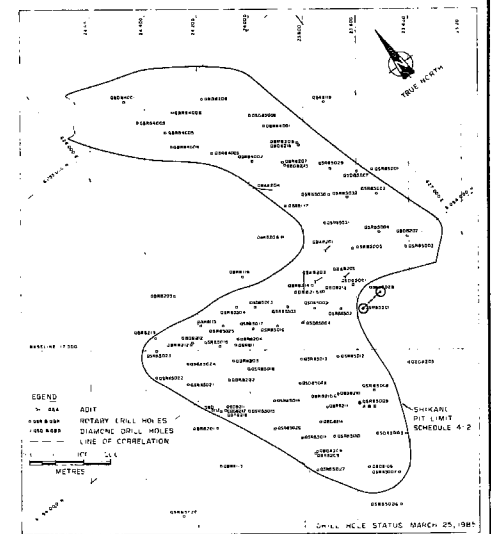

QSR 85028

80

QSR 85501

80

D SEAM

E SEAM

E3 SEAM

100.0

120.0

DATUM

F SEAM

G SEAM

J SEAM

K1 SEAM

K2 SEAM

200.0

218.4

80

160

140

80

180

200

LEGEND

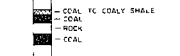

GEOPHYSICAL LOGS

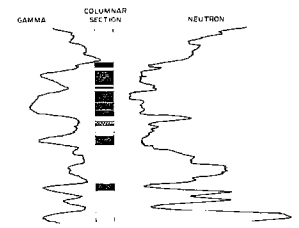
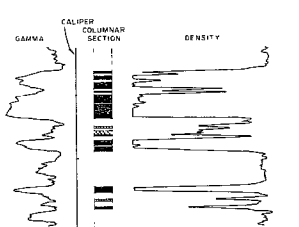

50 0 50 100 200 METRES (VERTICAL SCALE ONLY)

NOTE 1) ALL THICKNESSES ARE APPARENT
 2) ADDITIONAL BOREHOLE GEOPHYSICAL DATA IS AVAILABLE FOR MOST HOLES
 3) GAMMA / NEUTRON LOGS USED ONLY WHEN DENSITY LOG IS NOT AVAILABLE

Rev	Q	M	Y	Revision Description	Drn.	Des.	App.
1				ORIGINAL DRAFT	D.M.C.	K.T.J.	K.T.J.

QUINTETTE COAL LIMITED
 Project Manager
DENISON MINES LIMITED
 COAL DIVISION

Area SHIKANO Category CORRELATION

Drawing Title
SHIKANO
 DRILL HOLE GEOPHYSICAL LOG
 CORRELATION OF COAL-BEARING
 SECTION

SHEET 8 of 20

Scale 1:200(VERT) HORIZONTAL NOT TO SCALE	Drawing No 85-300-26-008	Rev 0
---	-----------------------------	----------

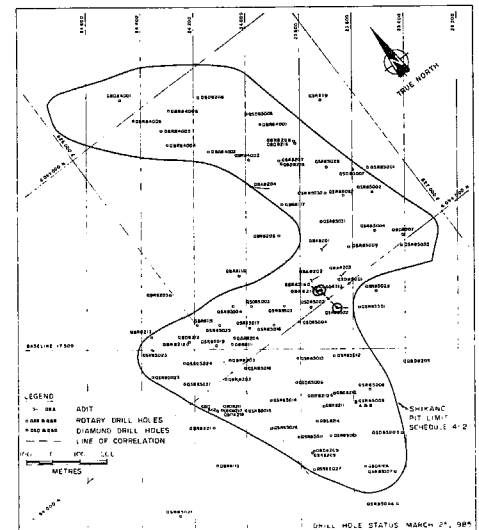

QSR 85502

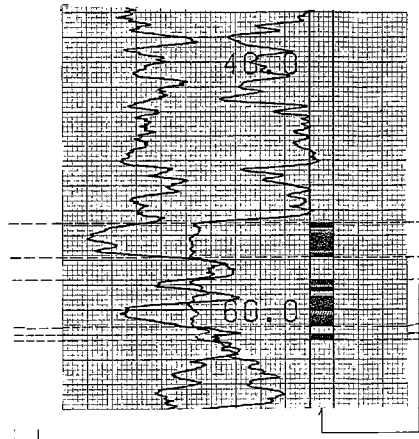

QBR 8215

QBD 8213

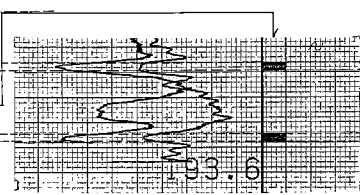
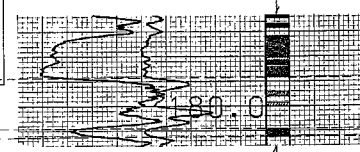
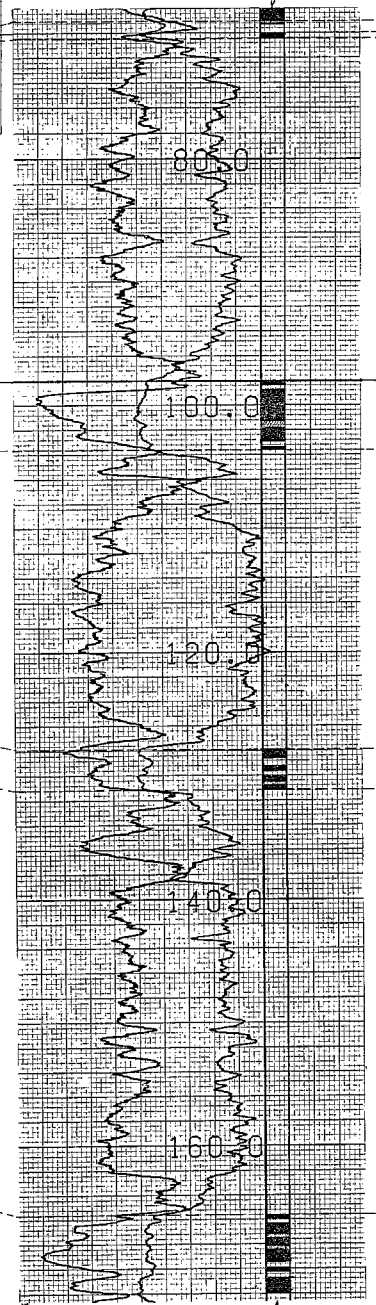
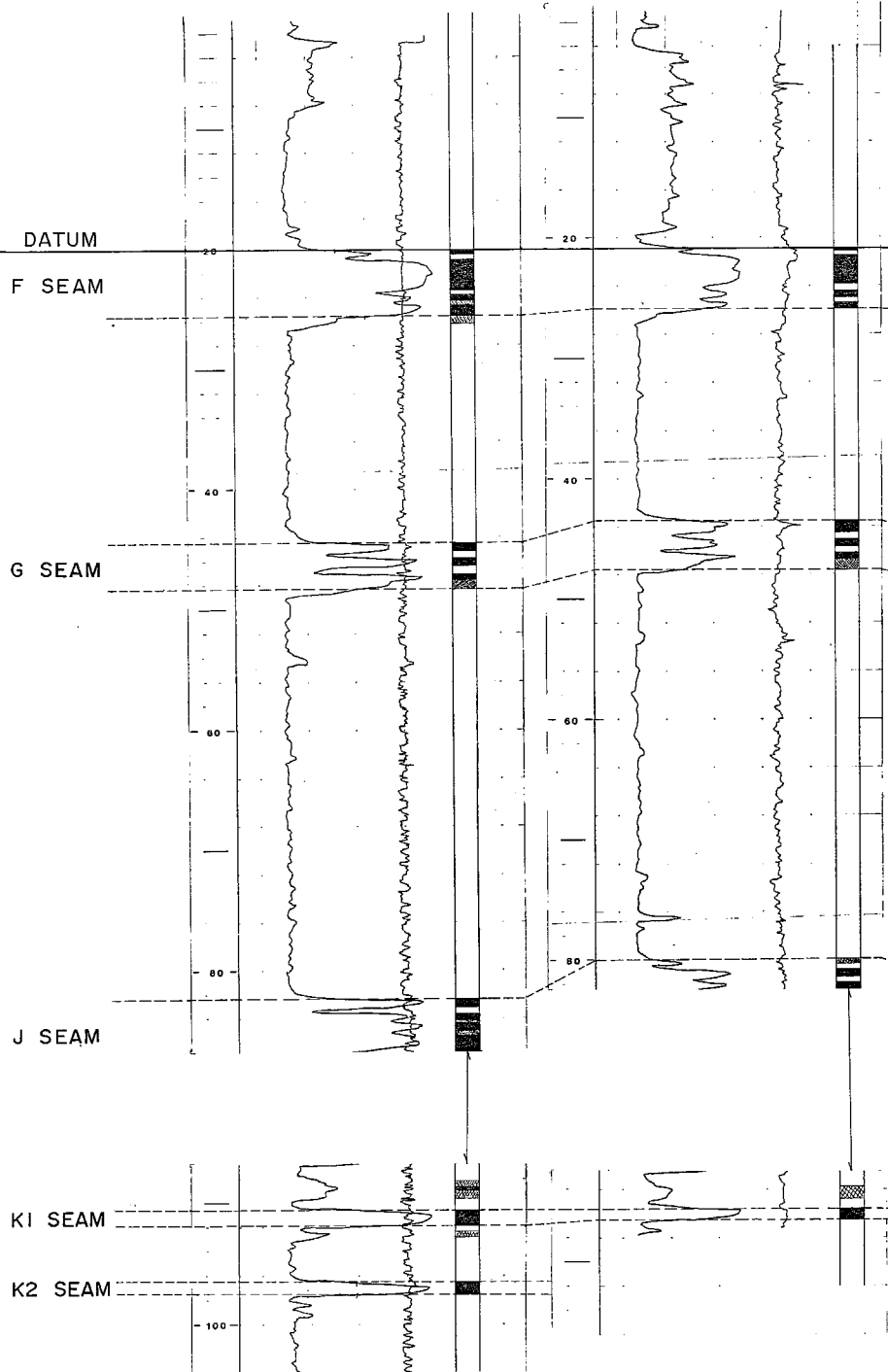

LEGEND

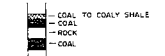

GEOPHYSICAL LOGS

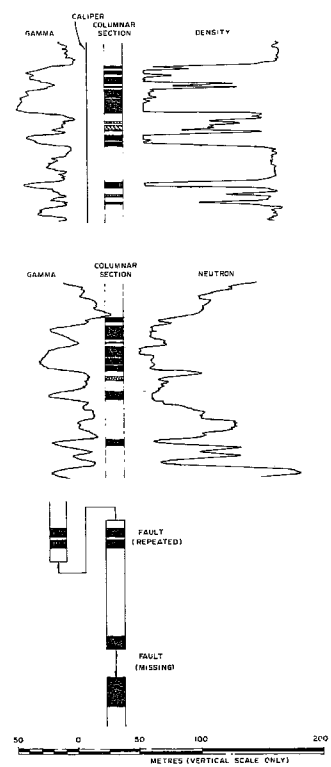

NOTE: 1) ALL THICKNESSES ARE APPARENT
 2) ADDITIONAL BOREHOLE GEOPHYSICAL DATA IS AVAILABLE FOR MOST HOLES
 3) GAMMA / NEUTRON LOGS USED ONLY WHEN DENSITY LOG IS NOT AVAILABLE

Rev.	Date	Description	Drn.	Des.	App.
0	10/05/05	ORIGINAL DRAFT	DM	KTJ	KTJ

QUINETTE COAL LIMITED
 Project Manager
DENISON MINES LIMITED
 COAL DIVISION

Area: SHIKANO Category: CORRELATION

Drawing Title:
SHIKANO
 DRILL HOLE GEOPHYSICAL LOG
 CORRELATION OF COAL - BEARING
 SECTION

Scale: 1:200(VERT)
 Drawing No.: 85-300-26-009
 Rev: 0

SHEET 9 of 20

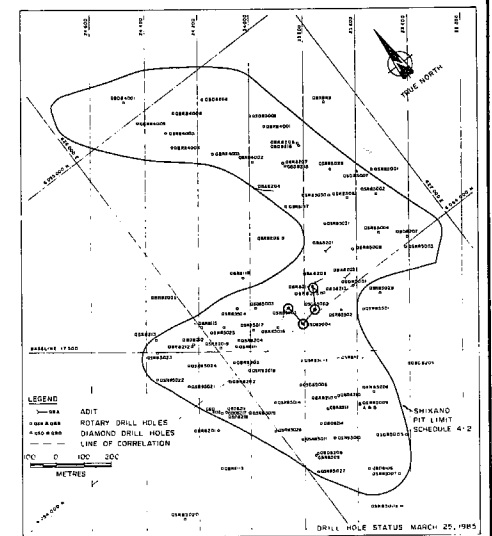

LEGEND

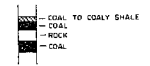

GEOPHYSICAL LOGS

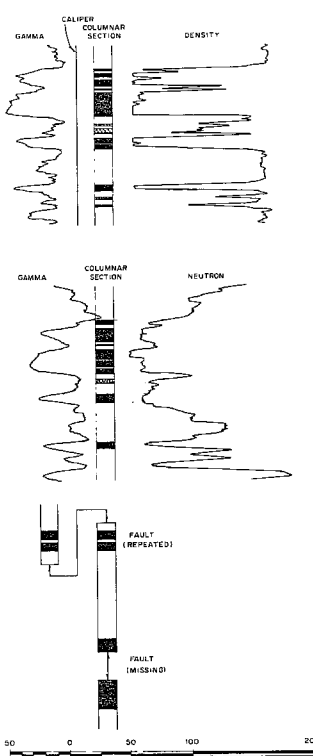

NOTE 1) ALL THICKNESSES ARE APPARENT
 2) ADIT DRILL, SCHEDULE GEOPHYSICAL DATA IS AVAILABLE FOR MOST HOLES
 3) GAMMA/NEUTRON LOGS USED ONLY WHEN DENSITY LOG IS NOT AVAILABLE

0	18	0585	ORIGINAL DRAFT	DMc	KTJ	KTJ		
Rev.	D	M	Y	Revision	Description	Drn.	Des.	App.

QUINTETTE COAL LIMITED
 Project Manager
DENISON MINES LIMITED
 COAL DIVISION

Area SHIKANO Category CORRELATION

Drawing Title
SHIKANO
 DRILL HOLE GEOPHYSICAL LOG
 CORRELATION OF COAL-BEARING SECTION

Scale 1:200(VERT)
 Drawing No. 85-300-26-010
 SHEET 10 of 20
 Rev. 0

QSD 85004

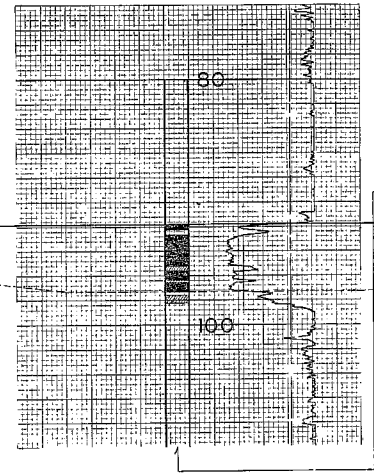

QSD 85002

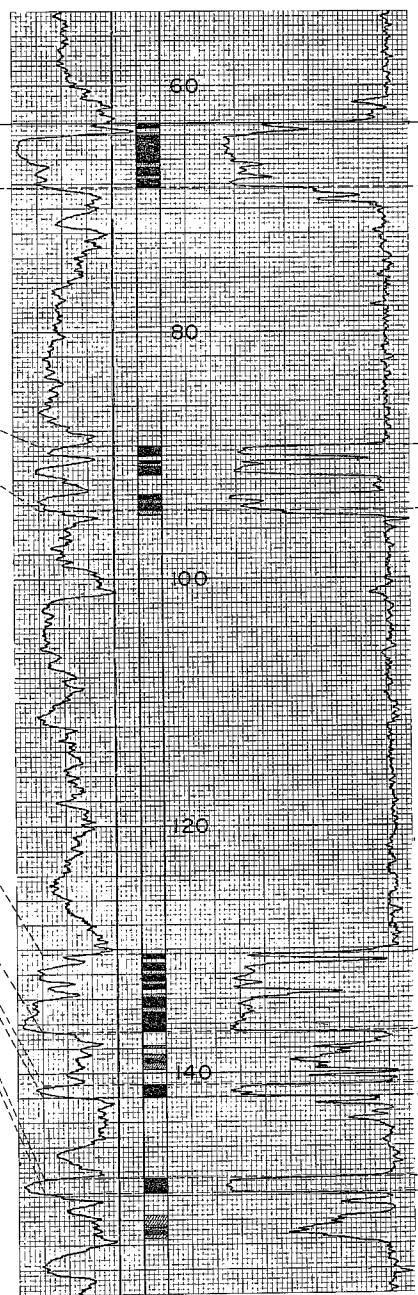

QBR 8214

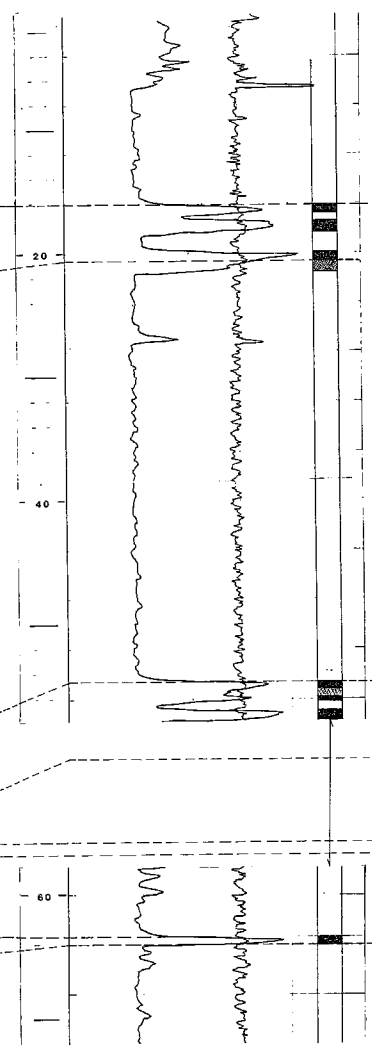

QSR 85503

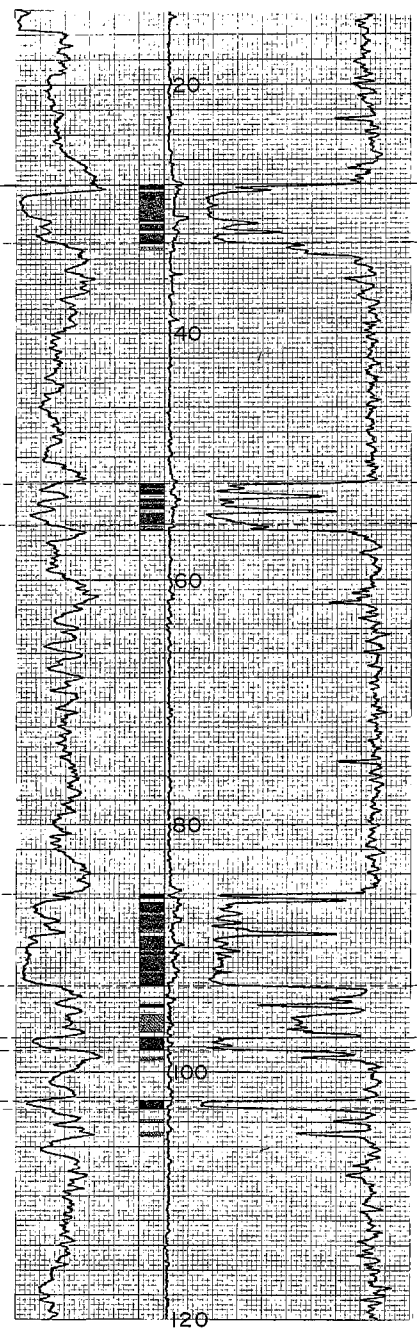

DATUM

F SEAM

G SEAM

J SEAM

K1 SEAM

K2 SEAM

KEY MAP

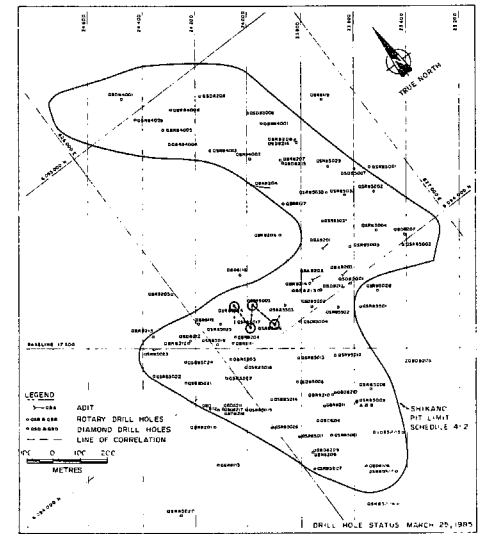

LEGEND

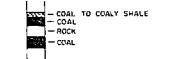

GEOPHYSICAL LOGS

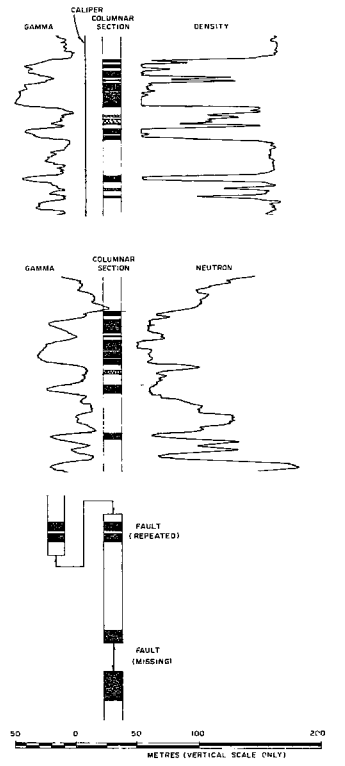

NOTE: 1) ALL THICKNESSES ARE APPARENT
 2) ADDITIONAL GEOPHYSICAL DATA IS AVAILABLE FOR MOST HOLES
 3) GAMMA / NEUTRON LOGS USED ONLY WHEN DENSITY LOG IS NOT AVAILABLE

0	18	25	03	ORIGINAL DRAFT	B Mc	KTJ	KTJ
Rev.	D	M	Y	Revision Description	Ors.	Des.	App.

QUINTETTE COAL LIMITED
 Project Manager
DENISON MINES LIMITED
 COAL DIVISION

Area SHIKANO Category CORRELATION

Drawing Title
SHIKANO
DRILL HOLE GEOPHYSICAL LOG
CORRELATION OF COAL - BEARING SECTION

Scale 1:200 (VERT.) Drawing No. 85-300-26-011 Rev. 0
 (HORIZONTAL, NOT TO SCALE)

QSR 85016

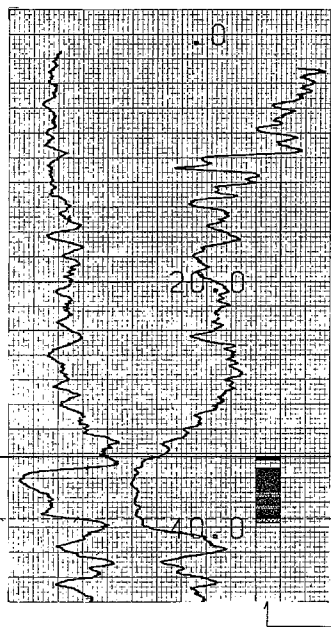

QSR 85017

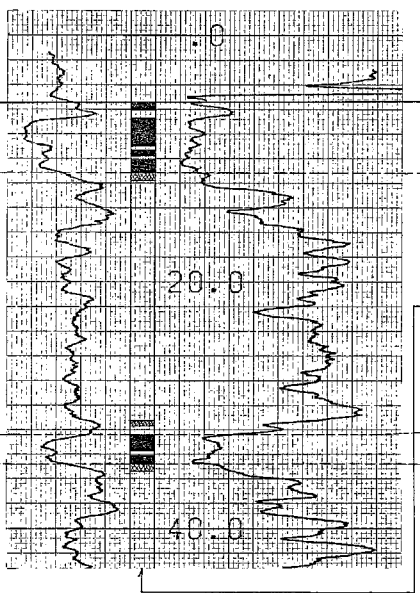

QSD 85003

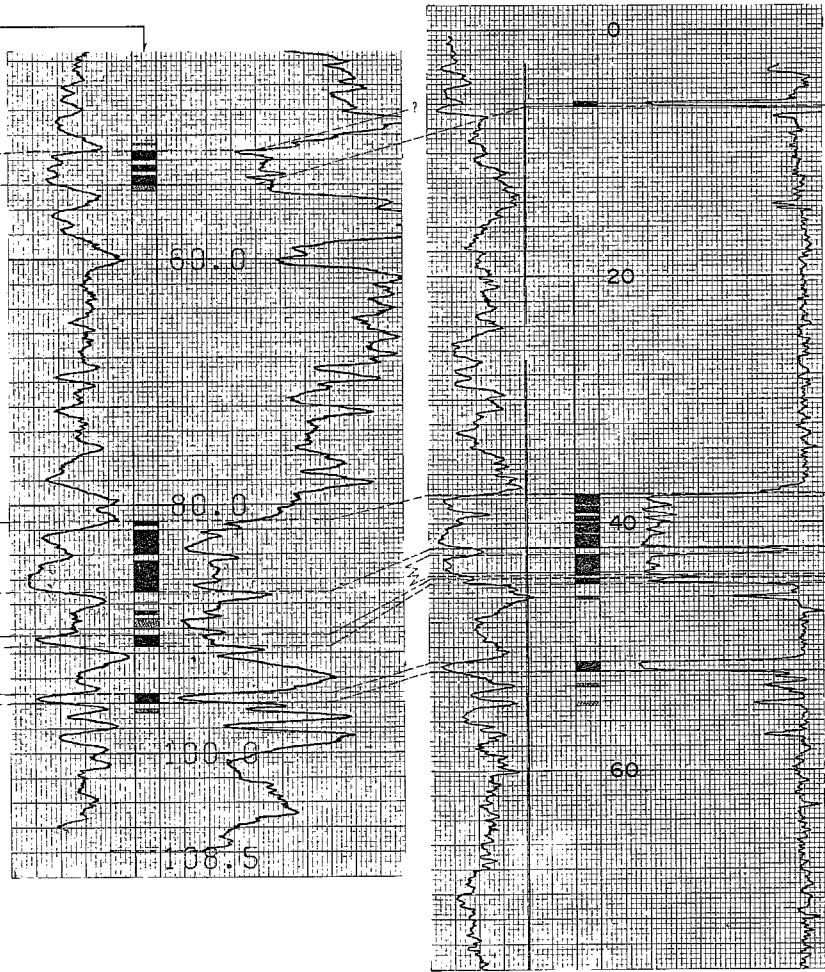

QSR 85504

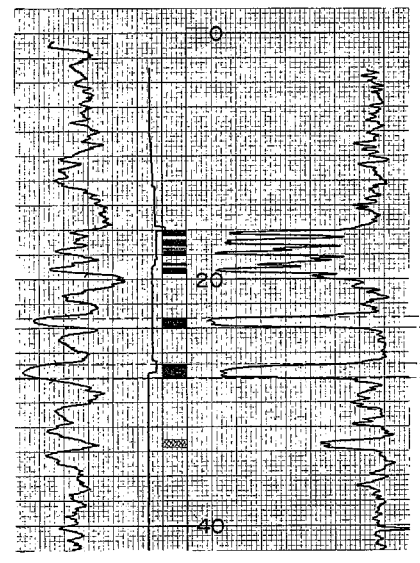

DATUM

F SEAM

G SEAM

J SEAM

K1 SEAM

K2 SEAM

KEY MAP

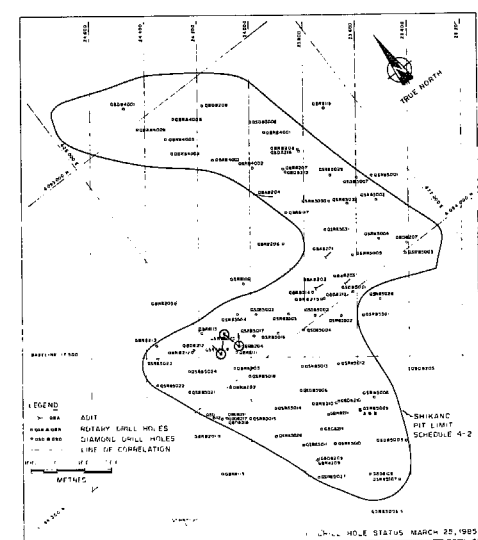

LEGEND

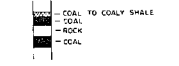

GEOPHYSICAL LOGS

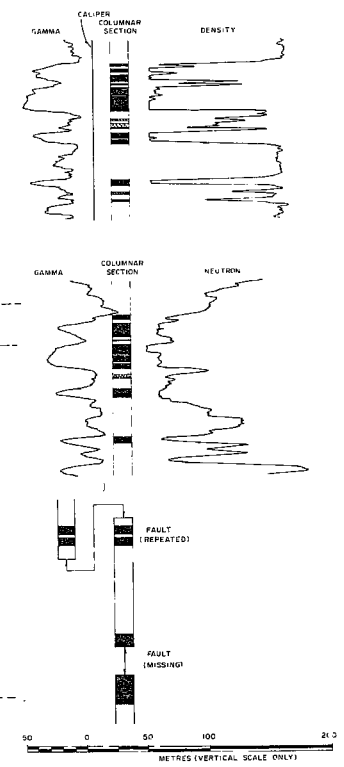

NOTE 1) ALL THICKNESSES ARE APPARENT
 2) ADDITIONAL BOREHOLE GEOPHYSICAL DATA IS AVAILABLE FOR MOST HOLES
 3) GAMMA NEUTRON LOGS USED ONLY WHEN DENSITY LOG IS NOT AVAILABLE

Rev. No.	Date	Description	Drn.	Des.	App.
0	18/05/05	ORIGINAL DRAFT	GME	KTJ	KTJ

QUINTETTE COAL LIMITED
 Project Manager
DENISON MINES LIMITED
 COAL DIVISION

Area: SHIKANO Category: CORRELATION

Drawing Title:
SHIKANO
DRILL HOLE GEOPHYSICAL LOG
CORRELATION OF COAL-BEARING SECTION

Scale: 1:200 (VERT.) Drawing No. 85-300-26-012 Rev. 0
 (HORIZONTAL NOT TO SCALE)

SHEET 12 of 20

QSR 85019

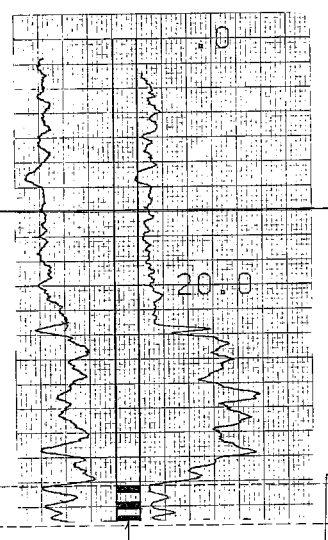

QBR 8204

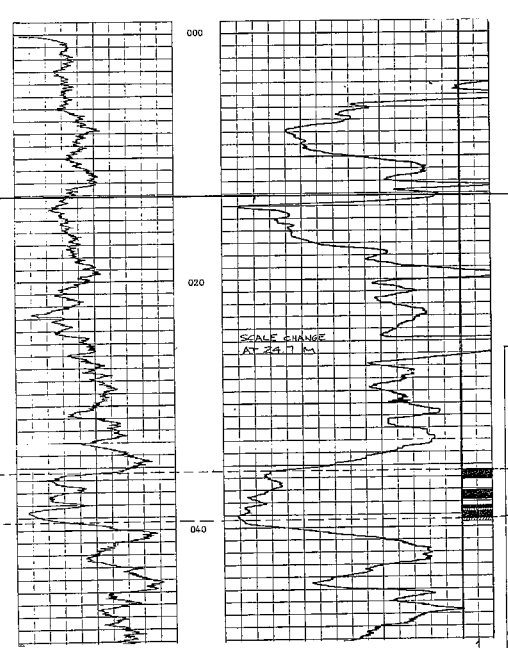

QSR 85025

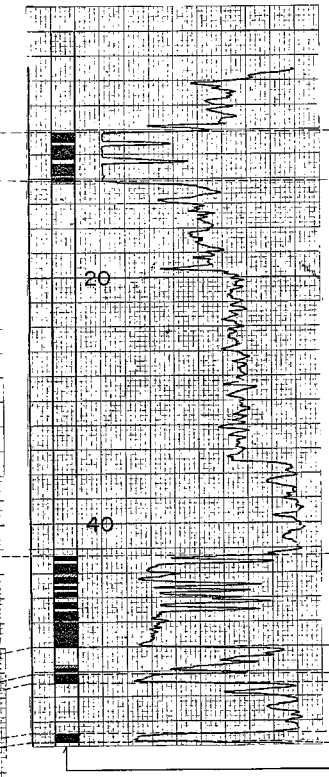

J SEAM
 K1 SEAM
 K2 SEAM

DATUM

G SEAM

KEY MAP

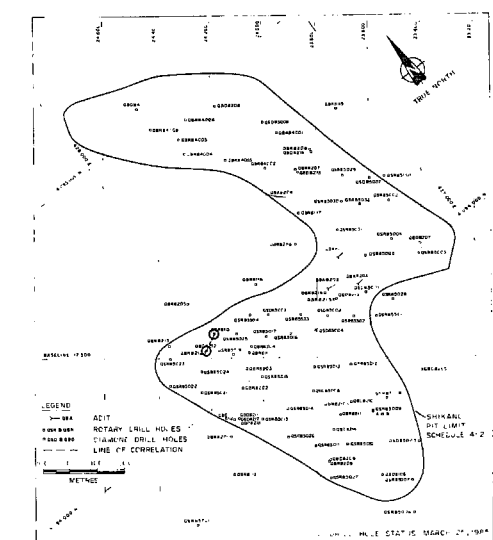

LEGEND

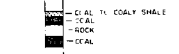

GEOPHYSICAL LOGS

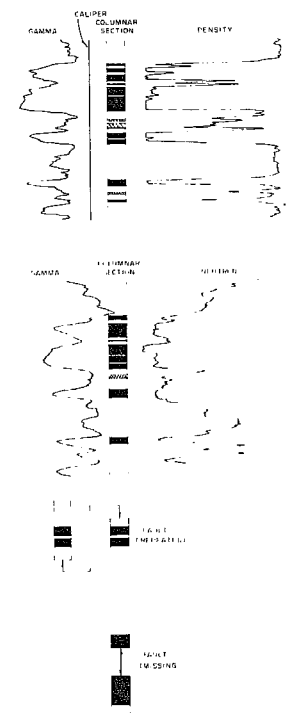

DATUM

QBD 8212

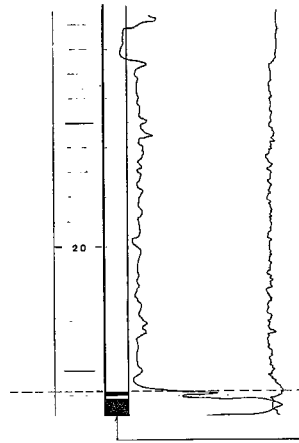

QBR 8115

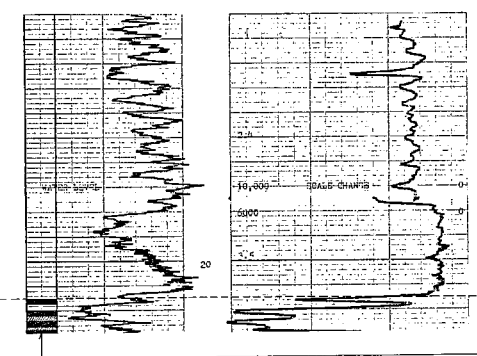

J SEAM

K1 SEAM

K2 SEAM

NOTE: 1. ALL THICKNESSES ARE APPARENT
 2. ADDITIONAL WIDE-ANGLE GEOPHYSICAL DATA IS AVAILABLE FOR MOST HOLES
 3. GAMMA RAY LOGS USE ONLY WHEN DENSITY LOG IS NOT AVAILABLE

Rev.	Q	M	V	Revision Description	Dir.	Des.	App.

QUINTETTE COAL LIMITED
 Project Manager
DENISON MINES LIMITED
 COAL DIVISION

Area: SHIKANO Category: CORRELATION

Drawing Title:
SHIKANO
 DRILL HOLE GEOPHYSICAL LOG
 CORRELATION OF COAL-BEARING
 SECTION

Scale: 1:200 (VERT.) Drawing No: 85-300-26-013 Rev: 0

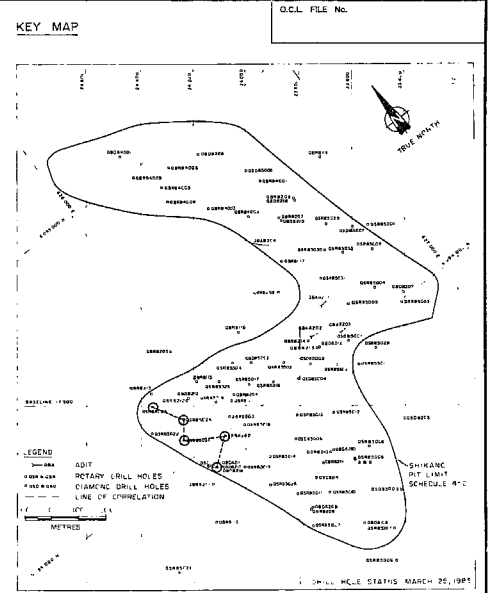

LEGEND

- COAL TO EARLY SHALE
- SHALE
- ROCK
- COAL

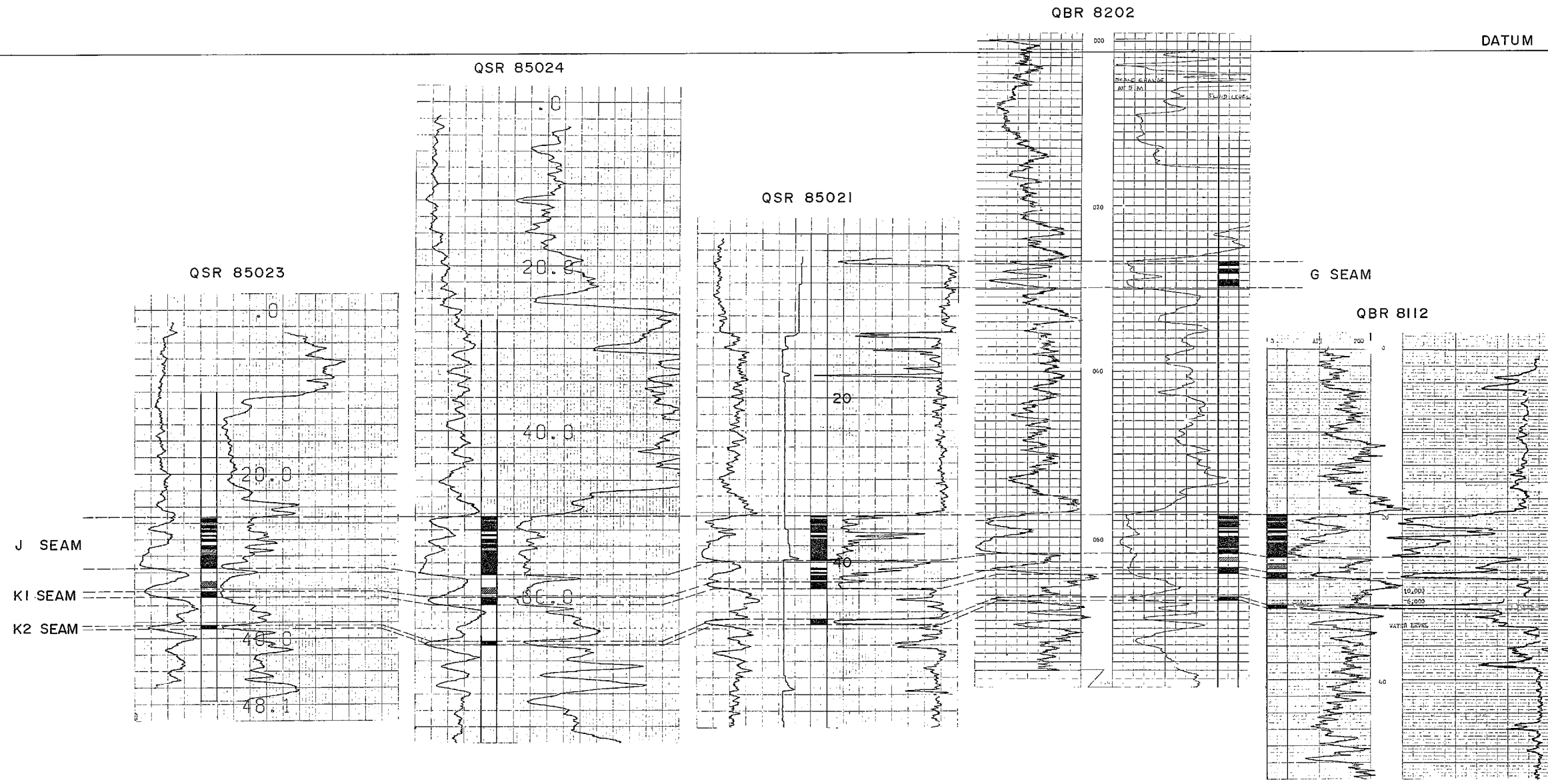
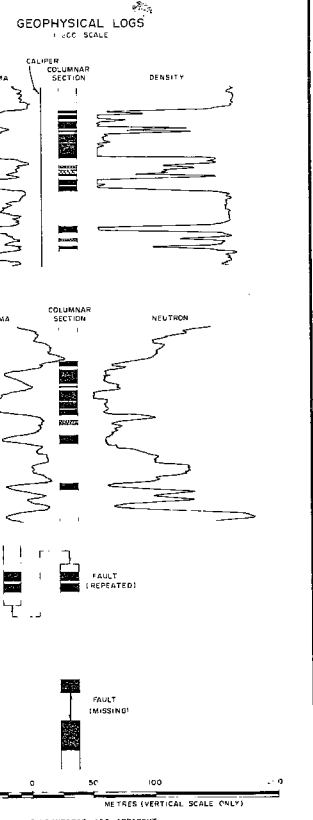

<p>QUINTETTE COAL LIMITED Project Manager</p> <p>DENISON MINES LIMITED COAL DIVISION</p>			
Area	SHIKANO	Category	CORRELATION
<p>Drawing Title</p> <p>SHIKANO DRILL HOLE GEOPHYSICAL LOG CORRELATION OF COAL-BEARING SECTION</p>			
SHEET 14 of 20			
Scale	1:200(VERT)	Drawing No.	85-300-26-014
<p>Rev. 0 (M/Y)</p>		<p>Rev. 0</p>	<p>Rev. 0</p>

KEY MAP

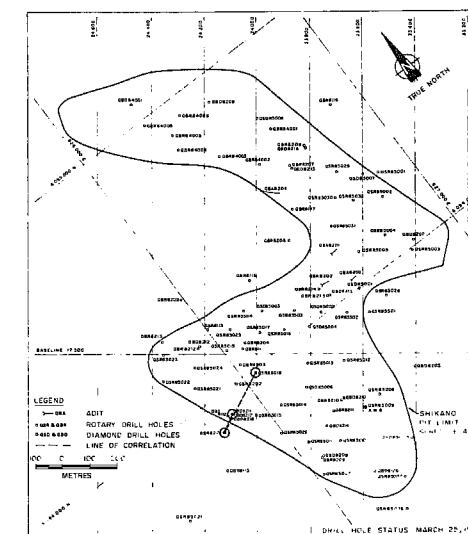

QSR 85018

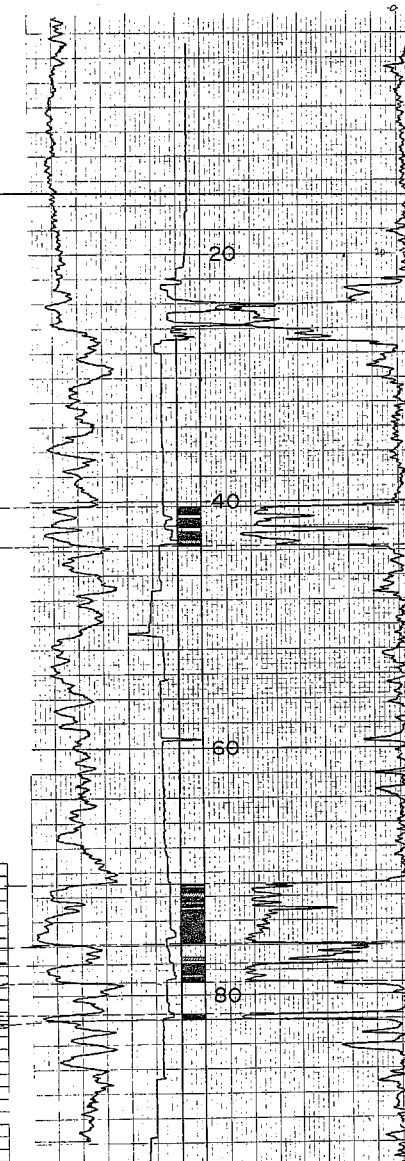

DATUM

G SEAM

J SEAM

KI SEAM

K2 SEAM

QBD 8211

QBD 8217

QBD 8218

QBR 8201

LEGEND

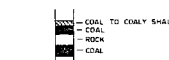

GEOPHYSICAL LOGS

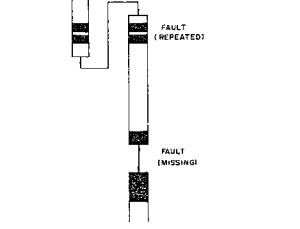
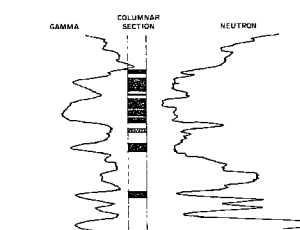
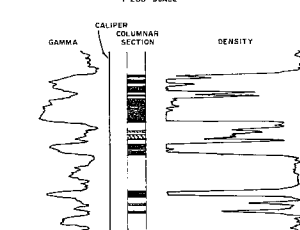

NOTE: 1) ALL THICKNESSES ARE APPROXIMATE
 2) ADDITIONAL GORENKE GEOPHYSICAL DATA IS AVAILABLE FOR MOST HOLES
 3) GAMMA/NEUTRON LOGS USED ONLY WHEN DENSITY LOG IS NOT AVAILABLE

Rev.	Drawn	Checked	Original Draft	Drawn	Des.	App.
0	18	08/05		DME	KTJ	KTJ
1	0		Revision Description	Drn.	Des.	App.

QUINTETTE COAL LIMITED
 Project Manager
DENISON MINES LIMITED
 COAL DIVISION

Area: SHIKANO Category: CORRELATION

Drawing Title
SHIKANO
 DRILL HOLE GEOPHYSICAL LOG
 CORRELATION OF COAL-BEARING SECTION

Scale: 1:200 (VERT.) Drawing No. 85-300-26-015 Rev. 0
 HORIZONTAL: NOT TO SCALE SHEET 15 of 20

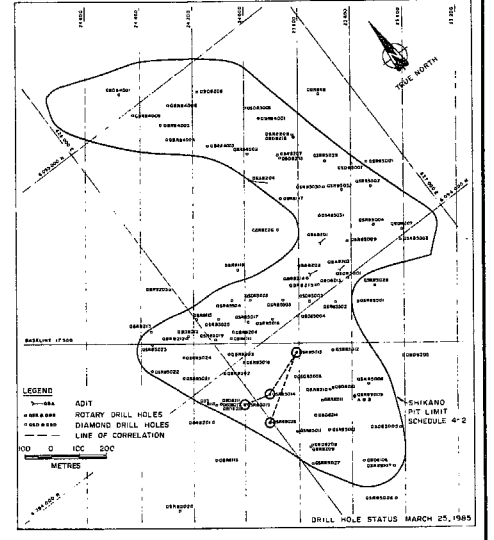

QSR 85013

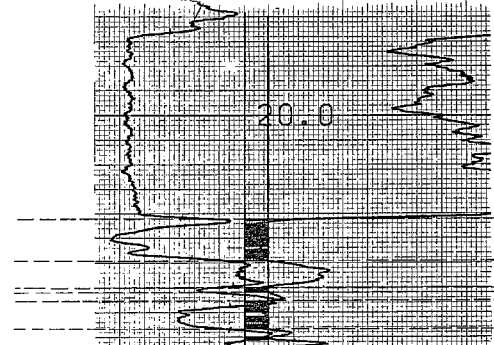

D SEAM
E1 SEAM
E2 SEAM

QSR 85014

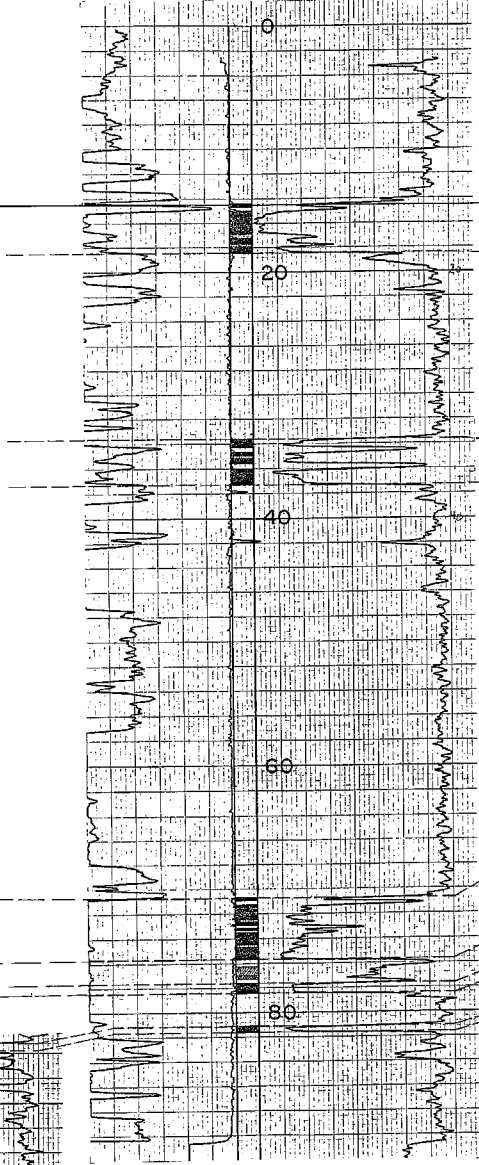

DATUM

F SEAM

QSR 85015

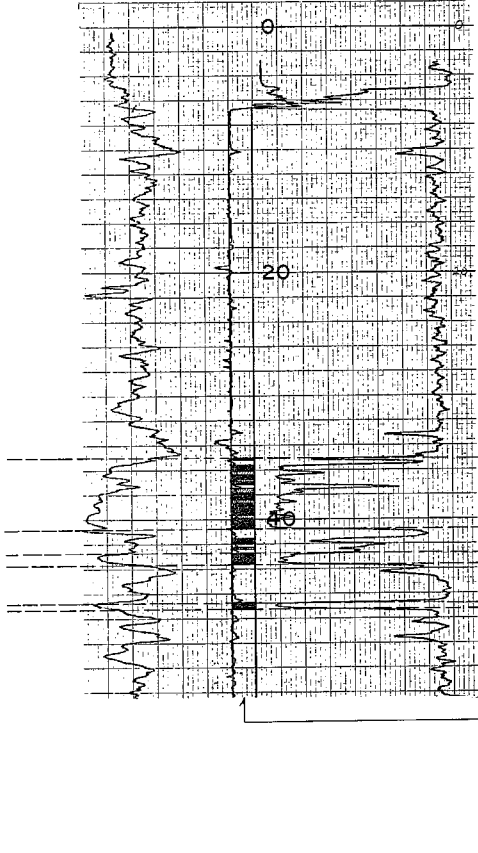

G SEAM
QSR 85026

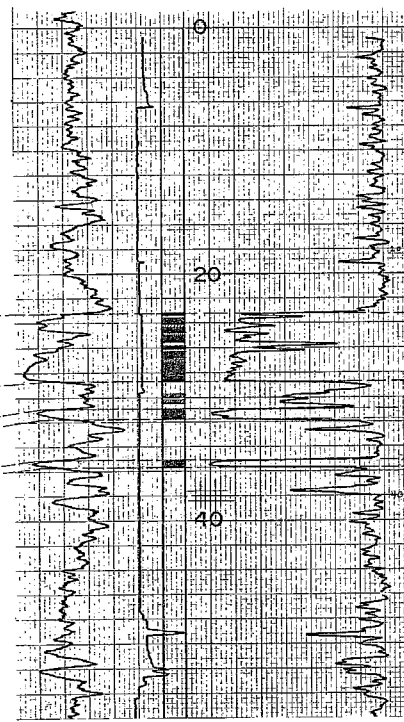

J SEAM
K1 SEAM
K2 SEAM

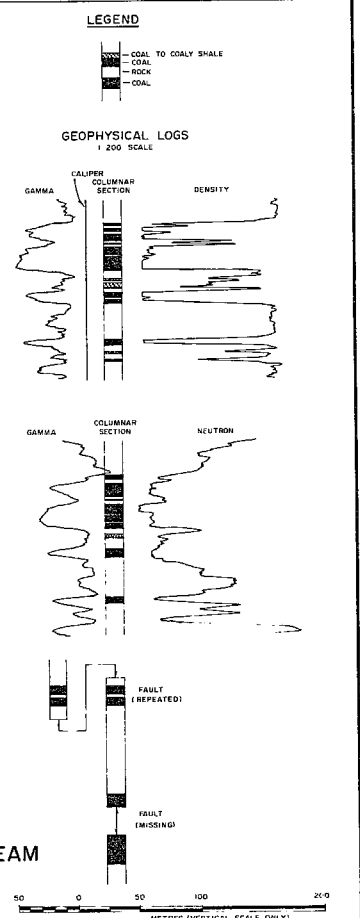

NOTE: 1) ALL THICKNESSES ARE APPARENT
 2) ADDITIONAL BENEATH GEOPHYSICAL DATA IS AVAILABLE FOR MOST HOLES
 3) GAMMA / NEUTRON LOGS USED ONLY WHEN DENSITY LOG IS NOT AVAILABLE

Rev.	Drawn	Checked	Designated	App.	
0	18/05/85		DMc	KTJ	KTJ
1					

QUINTETTE COAL LIMITED
 Project Manager
DENISON MINES LIMITED
 COAL DIVISION

Area: SHIKANO Category: CORRELATION

Drawing Title:
SHIKANO
 DRILL HOLE GEOPHYSICAL LOG
 CORRELATION OF COAL - BEARING
 SECTION

SHEET 16 of 20

Scale: 1:200 (VERT.) Drawing No.: 85-300-26-016 Rev.: 0
 (HORIZONTAL, NOT TO SCALE)

QSD 85006

QBR 8210

QSR 85012

QBD 8214

QSR 85011

D SEAM
E1 SEAM
E2 SEAM

DATUM

F SEAM

G SEAM

J SEAM

K1 SEAM

K2 SEAM

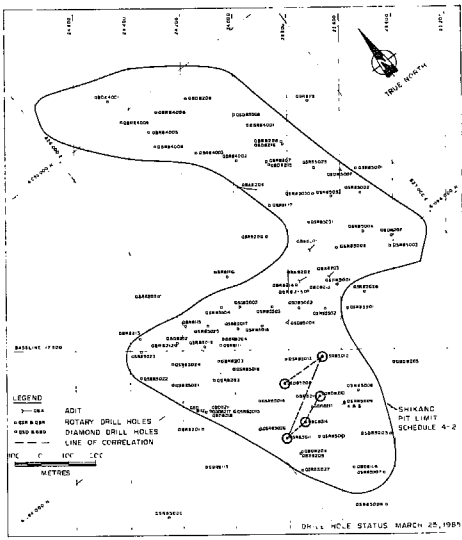

LEGEND

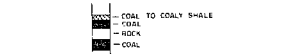

GEOPHYSICAL LOGS
1:200 SCALE

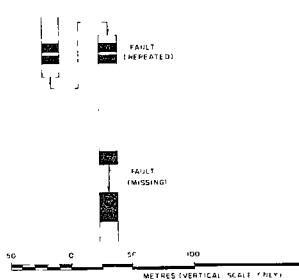
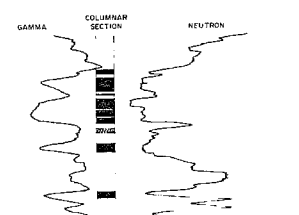
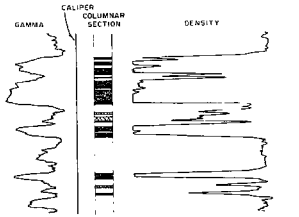

NOTE 1) ALL THICKNESSES ARE APPARENT
2) ADDITIONAL BOREHOLE GEOPHYSICAL DATA AVAILABLE FOR MOST HOLES
3) GAMMA/NEUTRON LOGS USED ONLY WHEN DENSITY LOG IS NOT AVAILABLE

Rev.	D	M	Y	Revision Description	Drn.	Des.	App.
C	18	05		ORIGINAL DRAFT	DMC	KTJ	MTJ

QUINETTE COAL LIMITED
Project Manager
DENISON MINES LIMITED
COAL DIVISION

Area SHIKANO Category CORRELATION

Drawing Title
SHIKANO
DRILL HOLE GEOPHYSICAL LOG
CORRELATION OF COAL-BEARING
SECTION

Scale 1:200(VERT.) Drawing No. 85-300-26-017 Rev. 0 SHEET 12 of 20

KEY MAP

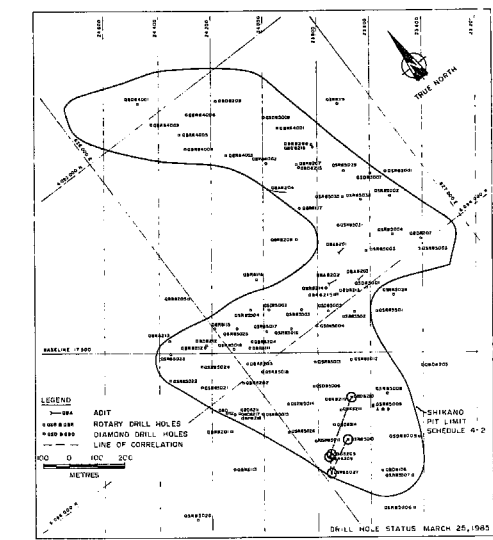

QBD 8210

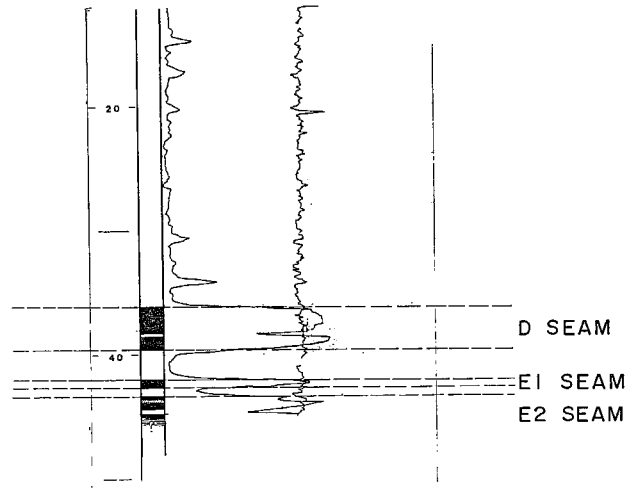

QSR 85010

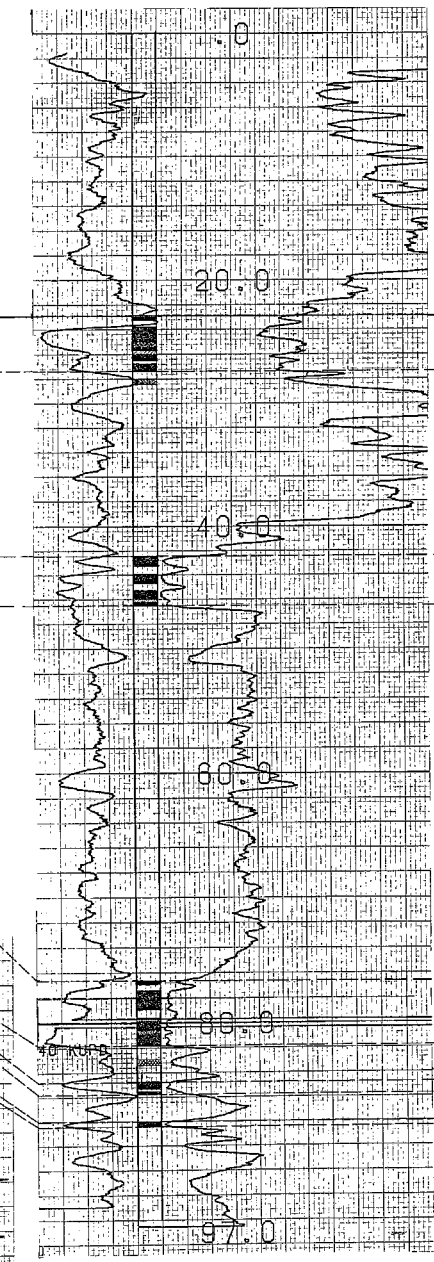

QBR 8209

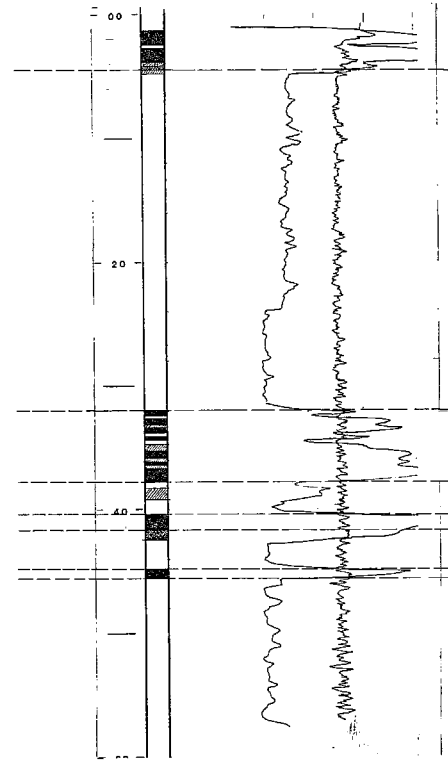

QBD 8209

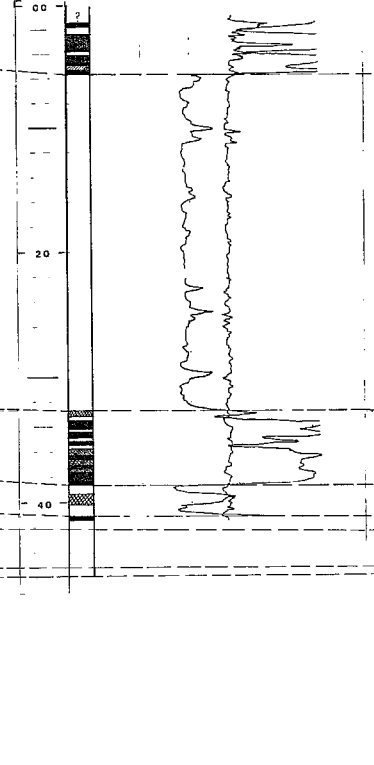

QSR 85027

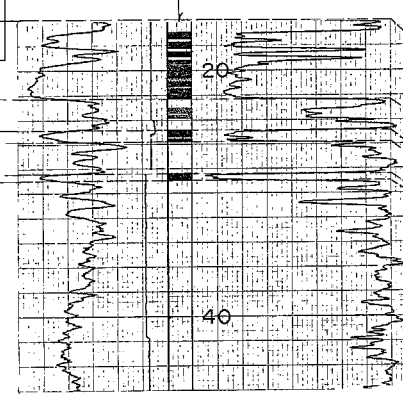
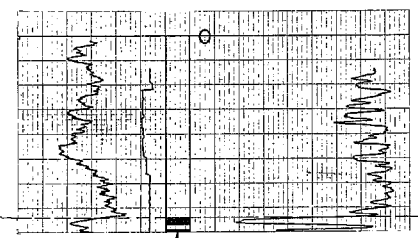

LEGEND

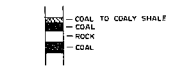

GEOPHYSICAL LOGS

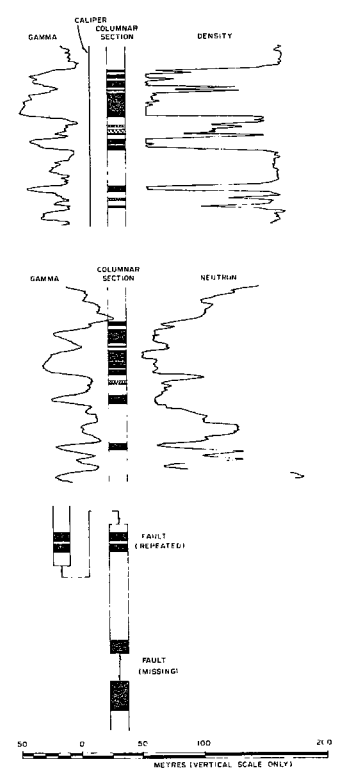

NOTE: 1) ALL THICKNESSES ARE APPARENT
2) ADDITIONAL BOREHOLE GEOPHYSICAL DATA IS AVAILABLE FOR MOST HOLES
3) GAMMA/NEUTRON LOGS USED ONLY WHEN DENSITY LOG IS NOT AVAILABLE

0	18/03/85	ORIGINAL DRAFT	DMc	KTJ	KTJ
Rev.	D	M	V	Des.	App.

QUINTETTE COAL LIMITED
Project Manager
DENISON MINES LIMITED
COAL DIVISION

Area: SHIKANO Category: CORRELATION

Drawing Title:
SHIKANO
DRILL HOLE GEOPHYSICAL LOG
CORRELATION OF COAL-BEARING
SECTION

Scale: 1:200 (VERT.)
Drawing No.: 85-300-26-018
Rev.: 0

SHEET 18 of 20

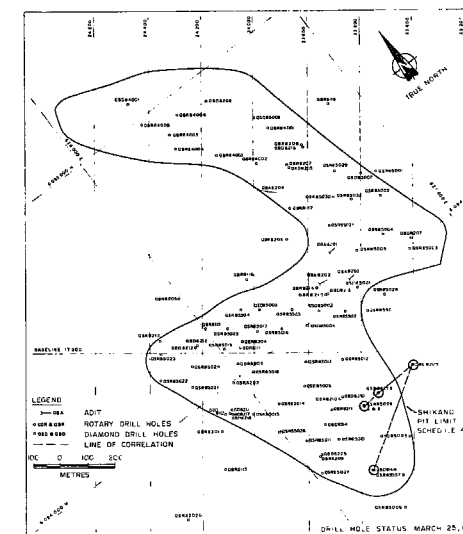

QSR 85009 B

QSR 85008

QBD 8205

QBD 8106

D SEAM
E1 SEAM
E2 SEAM

DATUM

F SEAM

G SEAM

J SEAM

K1 SEAM

K2 SEAM

LEGEND

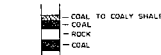

GEOPHYSICAL LOGS
1:200 SCALE

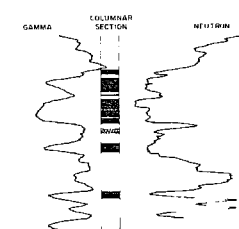
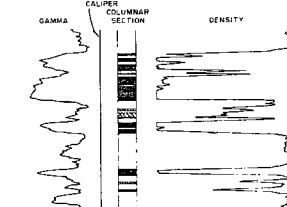

NOTE 1) ALL THICKNESSES ARE APPARENT
 2) ADDITIONAL BOREHOLE GEOPHYSICAL DATA IS AVAILABLE FOR MOST HOLES
 3) GAMMA-NEUTRON LOGS USED ONLY WHEN DENSITY LOG IS NOT AVAILABLE

Rev.	D	M	Y	Revision Description	Drn.	Des.	App.
0				ORIGINAL DRAFT	D.M.C.	K.T.J.	K.T.J.

QUINTETTE COAL LIMITED
 Project Manager
DENISON MINES LIMITED
 COAL DIVISION

Area SHIKANO Category CORRELATION

Drawing Title
SHIKANO
DRILL HOLE GEOPHYSICAL LOG
CORRELATION OF COAL-BEARING
SECTION

SHEET 19 of 20

Scale 1:200 (VERT.) Drawing No. 85-300-26-019 Rev. 0

KEY MAP

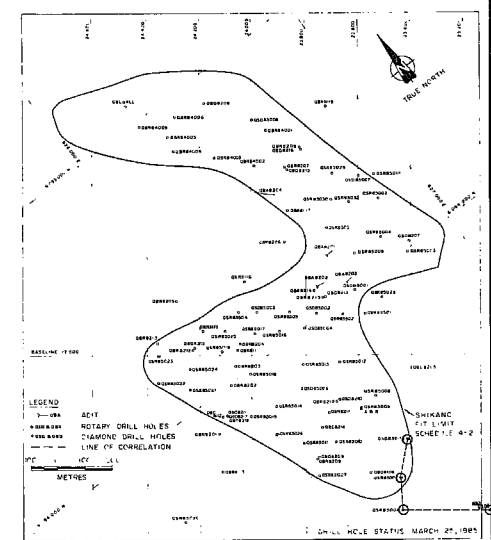

LEGEND

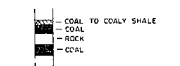

GEOPHYSICAL LOGS

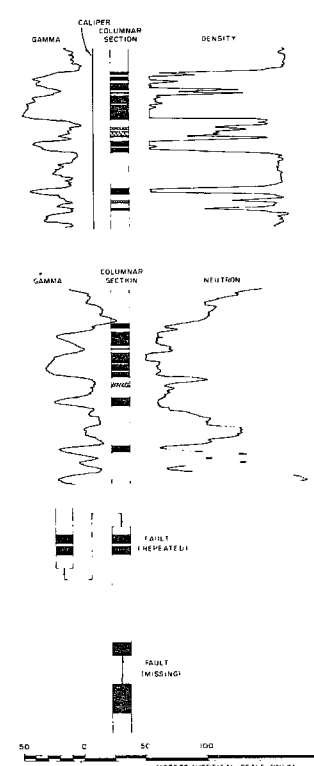

NOTE: 1) ALL THICKNESSES ARE APPARENT
 2) ADDITIONAL BOREHOLE GEOPHYSICAL DATA IS AVAILABLE FOR MOST HOLES
 3) GAMMA/RADIATION LOGS USED ONLY WHEN DENSITY LOG IS NOT AVAILABLE

0	2005/05	ORIGINAL DRAFT	DMc	KTJ	KTJ
Rev	D/M/Y	Revision Description	Drn.	Des.	App.

QUINTETTE COAL LIMITED
 Project Manager
DENISON MINES LIMITED
 COAL DIVISION

Area SHIKANO Category CORRELATION

Drawing Title
SHIKANO
 DRILL HOLE GEOPHYSICAL LOG
 CORRELATION OF COAL-BEARING SECTION

Scale 1:200(VERT)
 Drawing No 65-300-26-020
 SHEET 20 of 20
 Rev 0

QSD 85005

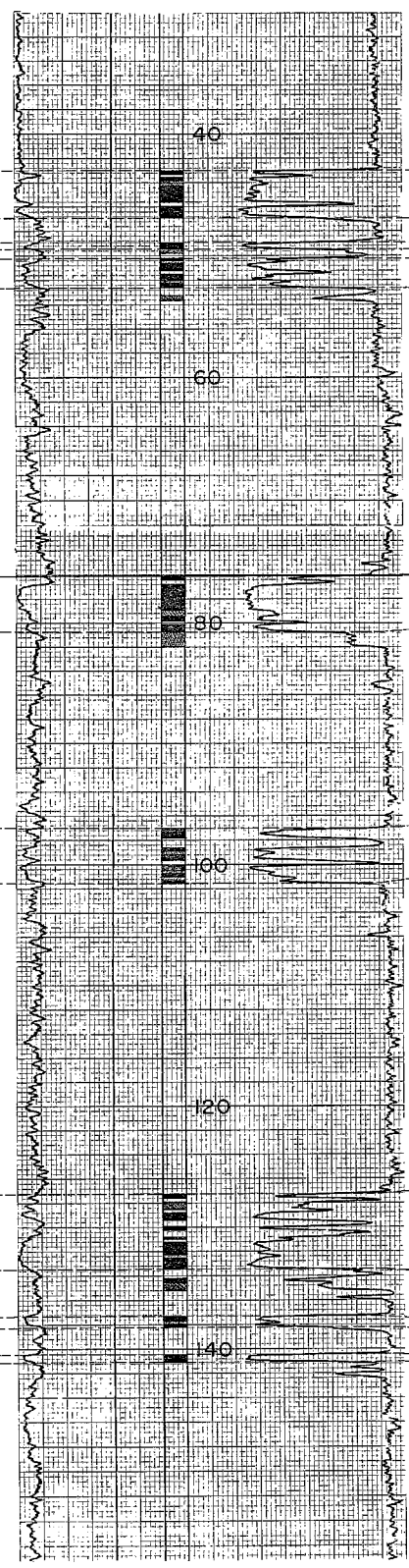

QSR 85007

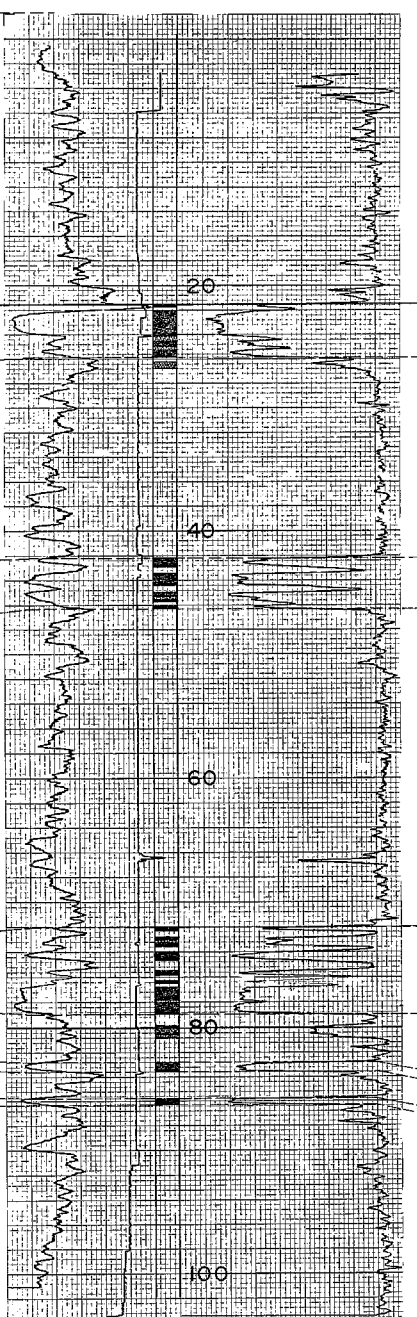

QSR 85006

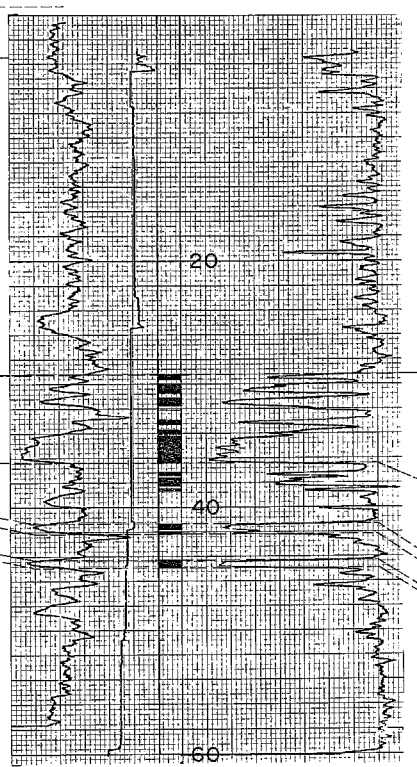

QBD 8206

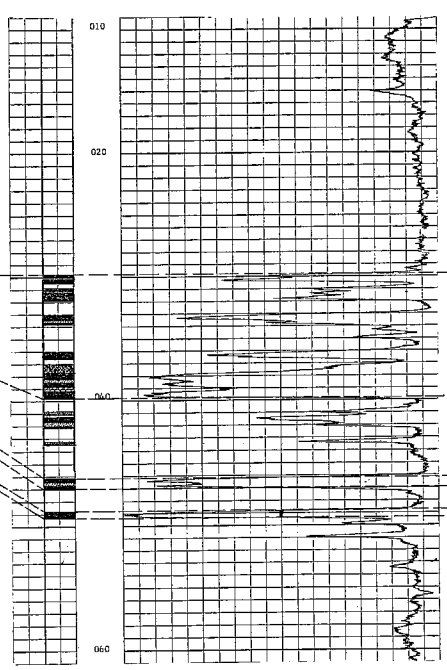

D SEAM
 E1 SEAM
 E2 SEAM

DATUM

F SEAM

G SEAM

J SEAM

K1 SEAM

K2 SEAM

APPENDIX 1

Section 1.9

Coal Seam Data Summaries

QUINTETTE COAL LIMITED

Shikano
Geological
Report

619



PITEAU ASSOCIATES
GEOTECHNICAL AND
HYDROGEOLOGICAL CONSULTANTS

KAPILANO 100, SUITE 408
WEST VANCOUVER, B.C.
CANADA V7T 1A2
TELEPHONE (604) 926-8551
TELEX 04-352896

DENNIS C. MARTIN
R. ALLAN DAKIN
ALAN F. STEWART
FREDERIC B. CLARIDGE
TADEUSZ L. DABROWSKI

QUINTETTE COAL LIMITED

**GEOTECHNICAL AND HYDROGEOLOGICAL ASSESSMENTS
FOR THE DESIGN OF OPEN PIT SLOPES
AND WASTE DUMPS FOR THE SHIKANO PROJECT**

Prepared by
PITEAU ASSOCIATES ENGINEERING LTD.

CONFIDENTIAL

May, 1985

EXECUTIVE SUMMARY

INTRODUCTION

This report describes the geotechnical and hydrogeological studies carried out for the design of open pit slopes and waste dumps for Quintette Coal Limited's proposed Shikano Project. The terms of reference for these studies are outlined in QCL Purchase Order #Q8503326-00-SV and in a letter from Piteau Associates Engineering Ltd. (PAEL) to Mr. J. Hendry of QCL on March 25, 1985. Studies were ongoing between February and April, 1985 and preliminary findings were discussed with QCL personnel at intermediate stages of the project. A draft summary report was prepared and transmitted to Mr. B. Wong of QCL on May 8, 1985. The draft report was reviewed by QCL personnel, subsequently finalized and submitted on May 25, 1985.

DESCRIPTION OF THE INVESTIGATION

A detailed program of geotechnical and hydrogeological data collection and evaluation was carried out to help characterize the rock mass and surficial soils in the vicinity of the proposed open pit and waste dump sites.

A general site reconnaissance was carried out and available bedrock outcrops were mapped for geologic structure. Mapping data were stereographically analyzed and discontinuity sets and spatial relationships were assessed. Diamond drill core from strategically located drillholes was geotechnically logged and photographed and bedding dips were recorded at regular intervals in the core. These data were assessed statistically and used in conjunction with existing information to evaluate discontinuity and rock mass characteristics and to aid in the overall geologic interpretation.

Sealed piezometers and open standpipes were installed in rotary drillholes to augment existing instrumentation. Falling head tests were carried out in all new and existing piezometer installations. Results were assessed in conjunction with existing information and estimates of the ranges of hydraulic conductivity and anisotropy of the rock mass were made. Water levels measured in piezometers and open drillholes and limited hydrogeological mapping were used to evaluate current groundwater conditions.

Steady-state, finite-element computer modelling was used to check the ranges of hydraulic conductivity and anisotropy estimated from field testing and to assess seepage inflows to the pit. Areas of potential groundwater problems were identified and possible remedial measures were suggested.

Analyses were carried out to determine the kinematically possible failure modes which could be expected on the various types of walls in the open

pit. Detailed slope stability analyses were carried out and slope design criteria were established for all footwall slopes. Specific slope design recommendations were established for individual hanging wall and endwall slopes and general slope design recommendations applicable to all slopes were prepared. A separate assessment of the feasibility of establishing a haulroad within the southwest footwall slope was carried out and appropriate design criteria established.

Airphotos covering the prospective pit and waste dump sites were reviewed and an interpretation of the origin, possible types and distribution of surficial soils was prepared. A detailed reconnaissance of the main proposed waste dump sites was carried out and natural soil exposures were mapped. Samples of surficial soils obtained from air rotary drilling were examined and a program of test pitting and sampling of various soil strata was undertaken. Test pit logs were prepared and gradation and index property testing of representative samples was carried out. This information was used in conjunction with information available from other studies to evaluate material characteristics and distribution within potential dump foundations. A detailed deep subsurface investigation of a portion of the South Dump site was recommended; however, this was deferred until a later stage. Field reconnaissance and test pitting in the vicinity of the Centre Dump site were not conducted for this study and have also been deferred to a later stage.

Based on the distribution of surficial sediments in the vicinity of the proposed waste dump sites, three basic dump foundation types were identified. Estimates of shear strength of the various soil strata were made, appropriate stability analyses were carried out and design guidelines were prepared for each foundation type. Based on these guidelines, recommendations were prepared for waste dump construction in the North and Alternate Dump sites and for the portion of the South Dump site not underlain by lacustrine silt. Preliminary design guidelines (subject to

confirmation by further investigation and/or analyses) were prepared for the portion of the South Dump underlain by lacustrine silt and for the Centre Dump site.

ENGINEERING GEOLOGY

The Quintette area lies within the Peace River Coal Field of northeastern British Columbia and is characterized by broad synclines and anticlines separated by low to medium angle thrust faults which dip towards the southwest. The Shikano Project area, located immediately southwest of the plant site, is characterized by flat to moderately steep (i.e. about 30° to 35°) topography which is crossed by a number of drainage courses. Mill Creek presently crosses the proposed pit area and will be diverted towards the south along a bench on the southeast endwall located near the pit crest and around the South Dump into M9 Creek.

Stratigraphic units which will form the various pit walls belong to the Lower Cretaceous Compton Formation and include the Gates and Hulcross Members. Rocks in the Gates Member consist of an interbedded, coal bearing sequence ranging from carbonaceous shales to sandstones and conglomerates, with six identified coal seams. These rocks will form the footwall slopes and the bulk of the hanging wall and endwall slopes. Overlying the Gates Member are the predominantly marine shales of the Hulcross Member. These rocks, which are expected to be somewhat less competent than the Gates Member rocks, may form small portions of the southeast and northeast walls of the pit near the crest.

The stratigraphy in the proposed pit is folded into a northwest-southeast trending syncline and associated anticline which plunge shallowly towards the southeast. These folds are relatively open with individual limbs dipping between about 15° and 55°. A few moderate to high angle thrust or reverse faults of limited extent and displacement are thought to exist, particularly within the core of the syncline. These faults are expected to strike approximately parallel to the dominant northwest-southeast regional structural trend.

Analyses of geologic structural data indicates that, in addition to bedding joints, two well developed sets of cross joints exist. Furthermore, it is apparent that the spatial relationship between these joint sets is fixed with respect to bedding such that, taken together with bedding joints, they form an approximately orthogonal system of jointing.

Primarily on the basis of the orientation of the various fold limbs, the proposed pit was subdivided into four **Structural Domains** as indicated in Fig. 4. Within each structural domain, the orientation of bedding and discontinuity sets is expected to be relatively consistent. Orientations of discontinuity sets within each structural domain have been inferred based on the mean orientation of bedding in each structural domain and on the fixed relationship known to exist between bedding and the various joint sets.

Bedding joints are expected to be relatively continuous with spacings varying from about 0.1m, in closely bedded carbonaceous shales and siltstones, to greater than 4m for more massive sandstones and conglomerates. Shear strength along bedding joints is assumed to be purely frictional with friction angles ranging from 26° for carbonaceous bedding joints to about 34° for clean bedding joints in competent sandstone rocks. Cross joints, however, are expected to be relatively discontinuous, being commonly truncated or offset by throughgoing bedding joints. Cross joints, which tend to be slightly rougher than bedding joints, are assumed to have friction angles of about 35° and negligible cohesion.

On the basis of stratigraphy and general rock competency, as demonstrated by the rock mechanics properties recorded from drill core, the rock mass may be subdivided into four basic units. **Hanging Wall Rocks** are interbedded shales, siltstones, sandstones and conglomerates stratigraphically above D Seam and are of moderate to relatively good quality. **Interseam Rocks** are interbedded coals and commonly carbonaceous shales to sandstones and

conglomerates between D and K Seams, inclusive, and are of relatively poor to moderate quality. **Immediate Footwall Rocks** are interbedded carbonaceous shales, siltstones and sandstones with occasional coal splits, generally occurring within a five metre stratigraphic depth below K Seam, and are of moderate quality. **Competent Footwall Rocks** are generally fine sandstones and siltstones which occur beneath the Immediate Footwall Rocks and are of relatively good quality. Based on the observed rock mechanics properties of core in each of these units, estimates of rock mass strength were prepared for use in subsequent stability analyses.

Results of the airphoto interpretation and the field and laboratory investigations indicate that a relatively thin blanket of loose to dense fluvio-glacial silt to gravel overlies a thin, well graded glacial till deposit, or rests directly on bedrock, in the vicinity of the North and Alternate Dump sites. Lenses of silt to gravel may also be present within the till which is generally very stiff but tends to be softer near the ground surface, particularly in areas of standing water. Similar formation conditions are also assumed to exist in the vicinity of the Centre Dump site; however, this assumption should be verified before finalizing dumping plans for this area.

Surficial geology of the South Dump site is somewhat more complex, consisting of at least six distinct deposits including colluvium, fluvial sand and gravel, lacustrine silt, glacial till, peat and alluvium. The silt deposit, which fills a depression in the central part of the site and may be as much as 35m to 45m thick, may be of particular importance to dump design. In this regard, additional investigations to confirm the areal extent, thickness and in situ strength characteristics of this deposit are necessary before a final dump design can be prepared for this area.

HYDROGEOLOGY

Groundwater flow systems in the Shikano area are expected to be local in extent, generally being isolated from regional flow systems by a thick sequence of Moosebar and Gething shales. Local flow systems tend to be shallow, reflecting stratigraphic control.

The catchment area for the proposed open pit is characterized by high relief and an estimated precipitation of 800 mm/yr. Recharge to groundwater via infiltration is expected to be about 15% of the annual precipitation. Colluvium and till, generally less than about 3m thick, cover the bulk of the pit catchment area. An upper bound estimate of groundwater flow through the surficial sediments into the proposed pit is about 8 lps.

Because of the bedded structure of the rocks in the vicinity of the Shikano Pit, the hydraulic conductivity of the rock mass is expected to be highly anisotropic, with the preferred groundwater flow direction parallel to bedding. In addition, the hydraulic conductivity of the rock mass is expected to be variable as a result of the variable lithology and natural fracture intensity. Based primarily on the results of falling head tests, the hydraulic conductivity of the rock mass parallel to bedding is expected to range between 5×10^{-8} m/s and 10^{-6} m/s. Anisotropy (i.e. the ratio of hydraulic conductivity parallel to bedding to hydraulic conductivity normal to bedding) is expected to range between 10 and 30. Water levels measured in sealed piezometers, open standpipes and open drillholes generally indicate the presence of strong downward (i.e. recharge) gradients across bedding, confirming the dominant geologic structural control and high anisotropy.

Steady-state, finite-element computer modelling was used to analyze both existing and post-mining groundwater flows and to predict the probable

range of groundwater conditions in the proposed open pit. Initially, the pre-mining condition was modelled to determine if the estimated ranges of hydraulic conductivity and anisotropy were reasonable. Results of this modelling indicate the rock mass hydraulic conductivity is about 10^{-7} m/s with an anisotropy of greater than 10, both of which are consistent with estimated values.

Following the initial pre-mining modelling, predictive modelling was carried out to assess potential groundwater inflows to the pit, water table positions and groundwater conditions in the pit walls. On the basis of modelling results, negligible inflows to the pit from the Murray River are expected. Steady-state inflows to the pit from various pit walls are estimated to be 19 lps. In addition, a transient inflow of 51 lps, due to release of groundwater from storage (primarily during the final year of mining) must be included, as well as the estimated 8 lps inflow from surficials. Hence, the total estimated groundwater inflow is 78 lps in the last year of mining. During the early phases of mining, groundwater inflows would be considerably less than this value. Because of the number and character of assumptions involved in these estimates, a range of $\pm 30\%$ should be allowed for in assessing sump and pumping requirements and in the design of settling ponds which would receive this water.

Modelling results also indicate that all slopes should be moderately drained and should not require any remedial dewatering. However, two conditions not considered by the modelling could adversely affect groundwater conditions behind certain slopes. Significant groundwater recharge to the southeast wall could result from leakage of the M11 Diversion channel or from groundwater flow in surficial sediments not intercepted by the diversion structure. In this regard, the M11 Diversion structure and diversion channel should be designed to limit leakage. Piezometric pressures in the southeast wall should also be monitored using existing and additional piezometer installations.

Natural groundwater flow from Babcock Mountain towards the Murray River could result in higher recharge to the northeast and southwest slopes than was considered in the modelling. Effects of this additional recharge on the northeast wall would be minimal because the strata are favourably oriented to promote natural drainage. The southwest wall, however, is a footwall slope excavated essentially parallel to bedding and may not drain naturally, resulting in potentially higher piezometric pressures in the slope. Alleviation of these pressures may require artificial depressurization, possibly in the form of short, vertical relief wells installed at intervals as the slope is excavated. This may be particularly important in the event that bedding is undercut to establish a permanent haulroad on this slope. In any case, natural depressurization of this wall should be monitored during the early stages of mining to establish the level of remedial depressurization required. Additional piezometer installations are required to provide sufficient monitoring information.

In addition to the above recommended monitoring, all existing piezometers should be monitored on a monthly basis starting from the present and continuing until they are destroyed by mining or mining is completed. Every effort should be made to preserve piezometer installations in drillholes QBD8205 and QSR85001. Monitoring will provide baseline hydrogeologic data and will allow an assessment of the groundwater conditions behind the pit walls during mining. If monitoring data indicates that additional depressurization is required to ensure stability of the slopes, appropriate depressurization measures could be implemented.

SLOPE STABILITY ANALYSES AND DESIGN

Based on the location of structural domains and the orientations of proposed slopes, the ultimate pit was divided into eleven Design Sectors, within which both the structural geology and general slope orientation are expected to be relatively constant (see Fig. 4). On the basis of these eleven design sectors, the proposed slopes may be subdivided into two basically different slope types: footwall slopes, which are excavated parallel or subparallel to bedding; and hanging wall or endwall slopes, which are excavated oblique or normal to the strike of bedding. Each of these slopes requires a fundamentally different stability analysis and slope design approach, as discussed in the following.

FOOTWALL SLOPES (DESIGN SECTORS VII, VIII AND IX)

Based on the current geologic interpretation, footwall slope stability is expected to be controlled by one of two basic modes of failure. Wherever bedding is to be undercut on a footwall slope, plane failure along bedding joints may control slope stability. Wherever the slope is excavated parallel to bedding, and bedding is sufficiently steep, bilinear slab failure, involving sliding along bedding joints combined with shearing through the rock mass in the toe of the slope, may control stability. Appropriate stability analyses were carried out to evaluate both of these failure modes. Because of their inherent differences in strength and geomechanical properties, separate analyses were conducted for Immediate Footwall Rocks and Competent Footwall Rocks.

Based on the results of stability analyses, familiarity with rock mass conditions, operational considerations and our experience with similar slope design situations in the McConkey Pit and other coal mines, design guidelines covering the anticipated range of footwall slopes were developed. Design guidelines for footwall slopes are summarized in Table III and an

example of how these guidelines would be applied to slope design on a typical section is shown on Fig. 24.

HANGING WALL AND ENDWALL SLOPES (DESIGN SECTORS I TO VI)

Kinematic assessments carried out for each proposed endwall and hanging wall slope indicate plane and/or wedge failures involving various combinations of cross joints control bench stability in all cases. However, because of the interbedded nature of the rock mass and the relative lack of continuity of cross joints, wedge and plane failures are expected to be limited by or "stepped" between continuous joints, as illustrated in Fig. 25. Based on the type and apparent plunge or dip of the failure considered to control stability, assessments of minimum catchment and access requirements and other operational considerations, and our experience with similar slope design situations, various possible slope designs were evaluated for each anticipated endwall or hanging wall slope. The optimum slope design is the one which establishes the steepest safe interramp slope angle while accommodating the occurrence of wedge and plane failures on the slope. Recommended slope designs for the various endwall and hanging wall design sectors are summarized in Table III. Although there are eight separate endwall and hanging wall design sectors indicated on Fig. 4, several of these have been considered together for practical design purposes. As a result, the number of unique endwall and hanging wall slope designs reduces to three as summarized in Table III. The various design parameters given in Table III are illustrated and defined in Fig. 25.

GENERAL SLOPE DESIGN GUIDELINES

In addition to recommendations concerning specific walls or wall types, the following are general recommendations which are applicable to all slopes.

- Design of final slopes must include zones of transition between design sectors. In general, recommended maximum intermediate slopes should not be exceeded within transition zones; however, it may be feasible to steepen slopes in these areas on a trial basis.
- Final wall blasts should be designed to minimize breakback of bench crest. In this regard, blasting trials should be carried out and evaluated to determine the optimum form of blast control. Ripping or other non-explosive excavation of coal next to final walls should be carried out whenever possible.
- Artificial support or rockfall protection measures may be required in some areas. Such measures could include rock bolting, dowels or mesh as required to protect critical installations or to stabilize unstable areas.
- All benches should be thoroughly scaled and berms kept reasonably clean of debris to maintain effective rockfall catchments.
- Existing and additional recommended piezometers should be monitored as the pit is developed. Results of monitoring will aid in determining the location, extent and optimum method of any required artificial groundwater depressurization.
- In-pit sumps or graded drainage ditches should be used to control precipitation and runoff within the pit.

- Trial slopes, consisting of higher benches, steeper bench face angles, and/or narrower berms than those recommended, should be incorporated into the slope on a trial basis, with due consideration given to operational constraints and ramifications of unsuccessful trials. Such trials are useful for verifying final slope designs.
- Monitoring hubs (survey control points) should be established on selected benches on all major slopes. In addition, periodic visual inspections of all slopes should be carried out. If slope movements are detected, monitoring frequency should be increased and the type of movement determined to aid in the design of remedial measures, if required.
- All slopes should be mapped and documented during excavation. The information should be used to update the geologic data base and reassess slope designs on an ongoing basis. Particular attention should be placed on identifying major faults, bedding rolls or other unfavourably oriented structures which could significantly affect overall slope stability.
- Although avalanches are not expected to be a serious concern, the potential for snow and avalanche problems should be assessed.

SOUTHWEST FOOTWALL RAMP

Construction of a proposed ramp on the southwest footwall slope would require undercutting bedding along its entire length. Based on the anticipated range of bedding dips expected along this area, the proposed ramp appears feasible, provided certain precautions and possible remedial measures are taken, as follows:

- Where bedding dips less than 20° , the haulroad cut may be excavated using a single bench inclined at about 60° as indicated in Fig. 26.
- Where bedding dips between 20° and 25° , an excavated slope utilizing an intermediate bench, as indicated in Fig. 26, is recommended. In addition, to prevent occasional small plane failures involving undercut Intermediate Footwall Rocks, one or two rows of dowels installed along the crest, as shown in Fig. 26, may be required. If required, these dowels should be installed prior to excavation of the cut.
- In all cases, a ditch should be incorporated to trap material rolling off undercut slopes.
- Carefully controlled blasting techniques should be utilized to minimize damage to the final cut face and footwall slope.
- Groundwater pressures should not be permitted to develop in near surface strata along the undercut section. In this regard, short, vertical relief holes may be required.
- Regular survey and visual monitoring of undercut slopes is recommended wherever bedding dips in excess of 20° . Monitoring should also be carried out during and/or following significant events such as blasts, substantial rainfall, spring thaw, etc.

Artificial depressurization and support requirements and designs can best be determined during the initial stage of excavation, once some first-hand experience with slope behaviour has been gained.

WASTE DUMP STABILITY ANALYSIS AND DESIGN

In addition to bedrock outcrops, at least six distinct soil deposits are exposed within the proposed waste dump sites (see Fig. 15). However, results of field and laboratory studies indicate that several of these deposits will behave similarly under proposed foundation loading conditions and, hence, may be considered together for purposes of analysis and design. Based on these assumptions, three basic foundation types were identified. Estimates of material shear strength and groundwater conditions were made and appropriate stability analyses were carried out for each foundation type.

Foundations composed of bedrock and mixed grained soils containing less than about 10% fines were considered as one foundation type. These may include coarse grained fluvial glacial and colluvial deposits. Such materials are expected to provide competent dump foundations and stability analyses indicate no limitations, other than routine performance monitoring, need be imposed on lift or dump height, given the maximum dump heights proposed.

Foundations composed of soils containing a mixture of fine and coarse sizes, including significant proportions of clay and silt, were considered as another foundation type. These include glacial till and some fluvial glacial and colluvial deposits, all of which may be relatively soft within the first few metres below ground surface. Stability analyses indicate that, based on assumed strengths and for a minimum Factor of Safety of 1.3, the maximum initial lift height is 22m. To maintain this factor of safety, a second lift of maximum 29m height would require a minimum setback of 40m between the toe of Lift 2 and the crest of Lift 1, corresponding to an overall slope angle of about 26° (see Fig. 28).

The third foundation type consists of fine grained soils, specifically the stratified lacustrine silt and clay deposit contained within the South Dump site. Based on limited penetrometer testing of samples from shallow test pits, stability analyses were carried out assuming an undrained shear strength of 50 kPa for this material. Because this material is potentially 35m to 45m thick and sampling depth was limited to about 6m, it is possible that the minimum shear strength at depth is less than 50 kPa. Hence, analysis results and design recommendations must be considered preliminary, subject to additional deep, subsurface exploration to confirm the shear strength profile of this deposit. Based on these assumptions and analysis results, to maintain a minimum Factor of Safety of 1.3 while advancing the dump across this deposit, maximum lift thicknesses and minimum setbacks should be as indicated on Fig. 28.

Based on the distribution of the three basic foundation types and on the above lift height and setback restrictions, recommendations concerning waste dump construction in each of the proposed sites were prepared and are summarized as follows:

Foundation Preparation

- Excessively soft material contained within wetland deposits should be excavated down to the level of competent till or colluvium. Peat deposits in excess of 150 mm thick should be removed.

North and Alternate Dumps

- The initial lift height should not exceed 22m and the second lift should not exceed 29m. Subsequent lifts, if required, should not exceed a thickness of 40m for the third lift and 55m for the fourth lift. Minimum setbacks should be maintained between the crest of the bottom lift and the toe of successive lifts, resulting in a maximum overall slope angle of 26°.

Centre Dump

- This dump should be constructed in two lifts to the maximum anticipated height of about 30m. The initial lift height should not exceed 22m and sufficient setback of the second lift should be such as to maintain an average overall slope of not more than 26°.

South Dump

- Where dumps are founded on colluvium or bedrock (above approximate elevation 850m) no restrictions on lift height or setbacks need be observed.
- Where dumps are placed on fluvio-glacial deposits (between approximate elevations 790m to 850m and below elevations 790m to 835m on Fig. 15), the same restrictions indicated above for the North and Alternate Dumps should be observed.
- Where dumps extend over the lacustrine silt deposit (between approximate elevations of 790m and 820m), initial lift thickness should not exceed 10m. The second lift should not exceed 17m and the third lift should not exceed 30m. Minimum setbacks of 80m should be maintained between lifts, corresponding to a maximum overall slope of 13.5°.

Additional Recommendations

- A minimum setback of 30m should be maintained between dump toes and the pit crest or conveyor line.
- Dump performance should be monitored during construction. Deformation and pore pressure measurements, particularly within the lacustrine silt deposit in the South Dump site, will serve to confirm dump behaviour and to warn of impending instability.

- Additional subsurface investigations and laboratory testing should be carried out to better delineate the extent and shear strength characteristics of the lacustrine deposit in the South Dump site. Based on results of this investigation, additional analyses should be carried out to confirm preliminary dump design guidelines for this material or to modify them as required. In conjunction with this investigation, a limited number of drillholes located within the till deposit in the North Dump site are recommended to confirm strength and consolidation assumptions used in stability analyses.

- Appropriate field reconnaissance and test pitting in the vicinity of the Centre Dump site should be carried out prior to commencement of dumping to verify assumed foundation conditions.

CONTENTS

	Page
1. INTRODUCTION	1
2. DESCRIPTION OF THE INVESTIGATION	2
2.1 Field Studies	2
2.1.1 Engineering Geology and Rock Mechanics	2
2.1.2 Hydrogeology	2
2.1.3 Surficial Geology and Waste Dumps	3
2.2 Office Studies	4
2.2.1 Engineering Geology and Pit Design	4
2.2.2 Hydrogeological Assessment	6
2.2.3 Assessment of Surficial Soils and Waste Dumps	7
3. ENGINEERING GEOLOGY AND SURFICIAL SOILS	9
3.1 Setting	9
3.1.1 Regional Geology	9
3.1.2 Location and Topography	9
3.2 Lithology	10
3.3 Structural Geology	13
3.3.1 Folds	14
3.3.2 Faults	15
3.3.3 Bedding and Bedding Joints	15
3.3.4 Cross Joints	16
3.4 Rock Competency and Core Quality	16
3.5 Rock Strength Properties	18
3.5.1 Shear Strength of Discontinuities	18
3.5.2 Rock Mass Strength	18
3.6 Description of Surficial Sediments	19
3.6.1 North Dump and Alternate Dump Sites	19
3.6.2 South Dump Site	21
3.6.3 Centre Dump Site	23

CONTENTS (cont'd.)

	Page
4. HYDROGEOLOGY	24
4.1 Regional Hydrogeology	24
4.2 Physical Influences on Local Hydrogeology	25
4.2.1 Physiography	25
4.2.2 Climate	25
4.2.3 Surface Water Hydrology and Infiltration	25
4.3 Groundwater Flow in Surficial Sediments	26
4.4 Groundwater Flow Through Bedrock	28
4.4.1 Hydrogeological Properties	28
4.4.2 Groundwater Flow System	30
4.5 Steady-State Computer Modelling of Groundwater Flow	31
4.5.1 Modelling Along Synclinal Axis	32
4.5.2 Modelling Along Section 23,800	34
4.6 Groundwater Inflows to the Pit	34
4.7 Groundwater Conditions Behind the Pit Slopes	36
4.7.1 Recharge from the Mill Creek Valley	37
4.7.2 Recharge Behind Southwest and Northeast Walls	37
4.8 Monitoring	38
5. SLOPE STABILITY ANALYSES AND DESIGN	40
5.1 Footwall Slopes (Design Sectors VII, VIII and IX)	40
5.1.1 Plane Failure	40
5.1.2 Bilinear Slab Failure	41
5.1.3 Footwall Slope Design Guidelines	42
5.2 Hanging Wall and Endwall Slopes (Design Sectors I to VI)	44
5.3 General Slope Design Recommendations	45
5.3.1 Blending and Modification of Recommended Slope Designs for Pit Planning Purposes	45
5.3.2 Final Wall Blasting, Blasting Trials and Ripping	45
5.3.3 Artificial Support and Related Remedial Measures	46
5.3.4 Cleaning Berms and Scaling	47
5.3.5 Groundwater Monitoring and Control	47
5.3.6 Control of Surface Water	48
5.3.7 Trial Slopes	48
5.3.8 Monitoring Slope Movement	49
5.3.9 Further Geotechnical Work	50
5.3.10 Snow Avalanche Problems	51

CONTENTS (cont'd.)

	Page
5.4 Design Recommendations for Southwest Footwall Ramp	51
5.4.1 Stability Analysis Relating to Undercut Bedding Above Ramp	51
5.4.2 Slope Design for Southwest Footwall Ramp	53
5.4.3 Special Considerations for the Southwest Footwall Ramp	54
6. WASTE DUMP DESIGN	56
6.1 Material and Groundwater Assumptions	57
6.1.1 Soil Overburden and Waste Rock	57
6.1.2 Bedrock	59
6.1.3 Groundwater	59
6.2 Stability Analyses and Dump Placement Concepts	60
6.2.1 Placement of Waste Rock Over Coarse Grained Soil and Bedrock	60
6.2.2 Placement of Waste Rock Over Mixed Grained Soils	61
6.2.3 Placement of Waste Rock Over Fine Grained Soil	63
6.3 Recommendations	65
6.3.1 Foundation Preparation	65
6.3.2 North and Alternate Dump Designs	65
6.3.3 Centre Dump Design	66
6.3.4 South Dump Design	67
6.3.5 Separation from Pit and Conveyor	68
6.3.6 Monitoring	68
6.3.7 Additional Investigations	68
7. ACKNOWLEDGEMENTS	70
8. REFERENCES	71

FIGURES

- FIGURE 1 Location Plan
- 2 General Stratigraphic Section
- 3 Geological and Drillhole Location Plan
- 4 Distribution of Structural Domains and Design Sectors
in the Ultimate Pit
- 5 GEODAT: Lower Hemisphere Equal Area Projection of All
Rotated Joints Relative to Bedding Orientation of 000/00
- 6 Shikano Cross Section 23,400
- 7 Shikano Cross Section 23,600
- 8 Shikano Cross Section 23,800
- 9 Shikano Cross Section 24,000
- 10 Shikano Cross Section 24,200
- 11 Shikano Cross Section 24,400
- 12 Shikano Cross Section 24,600
- 13 Section Along Synclinal Axis Through Shikano Pit
- 14 Detailed True Stratigraphic Thickness Graphic Logs of
Geotechnically Logged Holes
- 15 Waste Dump Plans, Surficial Geology and Subsurface
Investigations
- 16 South Waste Dump Sections
- 17 North Waste Dump Sections
- 18 Alternate Waste Dump Section
- 19 Summary of Modelling of Natural Groundwater Along
Synclinal Section

FIGURES (cont'd.)

- FIGURE 20 Summary of Modelling of Post-Mining Groundwater Flow Along Synclinal Section
- 21 Summary of Steady-State Computer Modelling Along Section 23,800
- 22 Results of Bilinear Slab Failure Analysis and Recommended Bench Geometry for 15m Bench Intervals in Immediate Footwall Rocks
- 23 Results of Bilinear Slab Failure Analysis and Recommended Bench Geometry for 15m Bench Intervals in Competent Footwall Rocks
- 24 Schematic of Typical Footwall Slope Configuration Based on Footwall Slope Design Guidelines
- 25 Slope Geometry Parameters
- 26 Recommended Southwest Footwall Ramp Design
- 27 Factor of Safety vs. Lift Height for Different Foundation Soil Strengths
- 28 Maximum Lift Thickness and Minimum Setbacks

TABLES

TABLE I	Results of Statistical Analysis of Geotechnical Core Logging Data
II	Summary of Piezometer Installations
III	Summary of Recommended Slope Design

PHOTOS

- PHOTO 1 Typical interseam shales and siltstones of the Gates Member.
- 2 Relatively massive conglomerates of the Gates Member stratigraphically above D Seam.
- 3 Interbedded coals, carbonaceous shales and siltstones of the Gates Member.
- 4 Typical sandstone/siltstone unit between Seams G and J. Note orthogonal jointing and stepped nature of rock face.

APPENDICES

- APPENDIX A Geotechnical Logs for Diamond Drillholes and Description of Core Logging and Cumulative Sums Techniques
- B Lower-Hemisphere, Equal-Area Projections of Poles to Discontinuities in Each Structural Domain
- C Test Pit Logs and Results of Gradation Tests

1. INTRODUCTION

This report presents the results of geotechnical and hydrogeological studies carried out for the design of open pit slopes and waste dumps proposed for Quintette Coal Limited's Shikano Project at Tumbler Ridge, B.C. The work was carried out under the direction of Quintette Coal Limited (QCL).

Field work was carried out between February and April, 1985. Analyses were ongoing in March and April, 1985. Discussions with mine personnel were held at various times throughout the studies to report progress and discuss preliminary findings. A summary draft report was prepared for review by QCL in early May, 1985. This report was subsequently finalized and submitted on May 25, 1985.

The terms of reference for the studies were discussed with Messrs. J. Hendry and B. Wong of QCL and briefly outlined in Purchase Order #Q8503226-00-SV issued by QCL. A more detailed scope of the study is outlined in a progress report to Mr. J. Hendry from Piteau Associates dated March 25, 1985.

It should be noted that only preliminary dump design guidelines are presented for the portion of the South Dump site underlain by lacustrine silt. Final analysis and design require additional deep subsurface investigations and testing, which have been deferred to a later stage. However, current plans do not anticipate dump construction in this area until 1987; hence, sufficient lead time is available for required additional studies.

2. DESCRIPTION OF THE INVESTIGATION

2.1 FIELD STUDIES

2.1.1 Engineering Geology and Rock Mechanics

Field work for the engineering geology and rock mechanics studies was conducted in February and March, 1985. During this time, approximately 835m (2740 ft.) of drill core from six diamond drillholes was geotechnically logged and photographed. Two other diamond drillholes were not geotechnically logged (although detailed geological logs were obtained) due to their close proximity to more relevant diamond drillholes that were fully logged. In addition to recording bedding dips at 1.5m (5 ft.) intervals, such parameters as rock type, recovery, RQD, frequency of bedding and cross joints, degree of breakage, weathering and hardness were recorded.

A general field reconnaissance and limited geologic structural mapping of available outcrops was carried out to obtain an appreciation for the character of and spatial relationship between bedding and the various joint sets.

2.1.2 Hydrogeology

Field work for the hydrogeology studies was carried out in conjunction with the engineering geology and rock mechanics studies discussed above. The field program was carried out to define baseline hydrogeologic conditions; to provide data for assessment of the need for, and feasibility of, artifi-

cial pit slope depressurization; and for evaluation of quantities of seepage inflow. The program included limited hydrogeological mapping, instrumentation, in situ permeability testing and water level monitoring.

Existing piezometers were located, sounded for depth and falling head tested to assess responsiveness and formation permeability. In some cases, damaged existing piezometers were repaired. A total of 22 piezometers in 8 existing drillholes were located and tested. Three sealed piezometers and one open standpipe piezometer were installed in each of air rotary holes QSR 85001 and QSR 85503. All new piezometer installations were also falling head tested.

Prior to conducting falling head tests, static water levels were measured in all piezometers. Static levels were also monitored in all piezometers just prior to completion of the field program. In addition, open hole water levels were measured in 17 drillholes (rotary and diamond) which were drilled as part of the 1985 exploration program.

2.1.3 Surficial Geology and Waste Dumps

Field work for the waste dump study was carried out primarily in April, 1985. An assessment of airphotos covering the three main proposed waste dump sites was conducted. Samples of surficial soils obtained at 1m intervals from rotary drillhole QSR 85020 were examined.

A program of test pitting combined with field reconnaissance of each of the South, North and Alternate Dump sites was carried out. Field reconnaissance and test pitting was not

carried out in the vicinity of the proposed small Centre Dump site. Existing soil exposures were examined and mapped, thirteen test pits were excavated with a backhoe to depths of up to about 6m and two test trenches were excavated with a bulldozer. The test pits and trenches were logged and samples of the various soil strata were obtained for laboratory classification and testing. Logs of test pits excavated in the vicinity of the South Dump site by Golder Associates (1985) were obtained and reviewed. The latter test pits were excavated in connection with sedimentation pond studies commissioned by QCL. Test pit logs prepared by Hardy Associates (1982) for the portion of the conveyor route between the North and Alternate Dump sites were also examined.

As discussed in the Introduction, a recommended detailed deep subsurface investigation of a portion of the South Dump site, using specialized soil drilling equipment, has been deferred until a later stage.

In addition to the above, other necessary information, including geological and geophysical logs (for all relevant diamond and rotary drillholes), plans and sections, etc. were assembled and reviewed.

2.2 OFFICE STUDIES

2.2.1 Engineering Geology and Pit Design

i) Geologic Structural Analysis

Geotechnical core logging and geological mapping data were compiled and processed using a Hewlett Packard 9845B desktop computer. Geotechnical logs of six

diamond drillholes were prepared and are included in Appendix A.

Geologic structural data from geological mapping were analyzed. Spatial relationships of discontinuities were assessed using computer sorting and statistical analysis techniques. Bedding dips from drill core were assessed statistically and compared with geological interpretations provided by QCL. All of this information was reviewed and incorporated in the ensuing stability analyses.

ii) Stability Analyses

Based on the results of the geologic structural analysis, kinematic analyses were carried out to determine the various kinematically possible failure modes that could be expected on the various types of walls. Detailed slope stability analyses were carried out and slope design criteria were established for all footwall slopes. Specific slope design recommendations were also established for individual hanging wall and end-wall slopes in the open pit. General slope design recommendations applicable to all walls were also prepared. Geotechnical implications of undercutting bedding to establish a permanent haulroad on the southwest footwall were assessed and appropriate design recommendations were prepared.

2.2.2 Hydrogeological Assessment

i) Data Review and Compilation

Previous reports concerning regional hydrogeology in the study area were reviewed and all water level and falling head test results were analyzed using standard procedures (Hvorslev, 1951). Anticipated ranges of hydraulic conductivity and anisotropy of the rock mass as a whole were determined.

ii) Computer Modelling

A two-dimensional, steady-state, finite-element computer model was used to model groundwater flow along a typical section parallel to the regional strike (i.e. northwest - southeast) through the proposed pit area. The purpose of this modelling was to provide a numerical check of the ranges of hydraulic conductivity and anisotropy estimated from the field program.

The same computer model was used to analyze groundwater flow along two representative sections, parallel and normal to the regional strike (i.e. northwest-southeast and northeast-southwest, respectively), in the pit area. A number of cases were run to assess how depressurization and seepage should vary with different hydraulic conductivities and storativities.

iii) Conclusions and Recommendations

Best estimates of potential seepage inflow to the pit from various sources were prepared. Groundwater conditions in proposed final pit walls were evaluated and potential problem areas defined. Recommendations concerning groundwater monitoring and possible remedial measures were prepared.

2.2.3 Assessment of Surficial Soils and Waste Dumps

i) Surficial Soils Assessment

On the basis of the results of the airphoto study, field reconnaissance, test pitting and a limited amount of rotary drilling (to determine depth to bedrock), the approximate extent and type of near surface (i.e. within 6m of surface) soils was delineated for the North, South and Alternate Dump sites. Detailed assessments of surficial soils in the vicinity of the Centre Dump site were not carried out for this study.

ii) Laboratory Testing

Soil samples were classified according to the Unified Soil Classification system. Pertinent features such as colour, particle size, consistency, particle angularity, degree of weathering and plasticity were recorded, as appropriate. A hand penetrometer was used to estimate the undrained compressive strength of cohesive soils. Atterberg limit and gradation tests were conducted on representative samples.

iii) Stability Analyses

Strength parameters for the waste rock were estimated based on the behaviour of existing waste dumps at the McConkey Mine, as well as from experience with other coal mine waste dumps in the Rocky Mountains region. Shear strengths for the foundation materials were estimated from pocket penetrometer and other laboratory test results. To finalize shear strength parameters for the deep, soft soils under a portion of the South Dump site, further sophisticated in situ and laboratory strength tests will be required.

Based on the distribution of surficial sediments in the vicinity of the potential dump sites, three basic dump foundation types were identified. Stability analyses were carried out using estimated material strengths for each of the three foundation types. The Janbu analysis method for generalized slip surface configurations was utilized. On the basis of these analyses, design guidelines were prepared for each type of foundation. Based on these guidelines, recommendations were prepared for waste dump construction in the North and Alternate Dump sites and for the portion of the South Dump site not underlain by lacustrine silts. Preliminary design guidelines (subject to confirmation by further investigation and/or analyses) were prepared for the portion of the South Dump underlain by lacustrine silt and for the small Centre Dump.

3. ENGINEERING GEOLOGY AND SURFICIAL SOILS

3.1 SETTING

3.1.1 Regional Geology

The Shikano Project area (see Fig. 1) lies within the Peace River Coal Field of northeastern B.C. This coal field is characterized by structural disturbances that resulted from its proximity to the Rocky Mountain structural zone. All major structural features follow a general northwest-southeast trend, reflecting the Rocky Mountain fold structure. The main geological structures in the Quintette area are broad synclines and anticlines which are separated by low to medium angle thrust faults which dip to the southwest.

The regional stratigraphy is summarized on Fig. 2. A brief description of the more relevant lithologic units is given below in Section 3.2.

3.1.2 Location and Topography

As shown on Fig. 1, the Shikano Project area is located on the eastern side of the Murray River immediately southwest of the plant site and northwest of Babcock Mountain, between elevations of about 760m and 1000m. In the proposed pit area the natural topography is variable, ranging from nearly flat to moderately steep (i.e. about 30° - 35°). In general, the steeper natural slopes exist in the southeastern portion of the proposed pit area (i.e. upper slopes). In the vicinity of the South Dump site, the topography is somewhat the same

as in the pit area, being as steep as about 25° to 30° in the upper portion of the proposed dump and less than about 10° over the remainder. In the vicinity of the North and Alternate Dump sites, the topography is somewhat more subdued with most natural slopes (with the exception of a few local slopes in drainage courses) being less than about 10° .

The Shikano area is crossed by a number of drainage courses. Mill Creek, which at the present time crosses the proposed pit area, will be diverted towards the south along a bench on the southeast endwall located near the pit crest and around the South Dump into M9 Creek. Creeks M13 and M 15 flow through the proposed locations of the North and Alternate Dumps, respectively.

3.2 LITHOLOGY

The stratigraphic units exposed in the Shikano area belong to the Lower Cretaceous Commotion Formation (see Figs. 2 and 3). The coal bearing sequence is part of the Gates Member, which is composed of an interbedded sequence ranging from carbonaceous shales to sandstones with some zones of conglomerate (see Photos 1 to 4). A number of coal seams (i.e. D, E, F, G, J and K) have been identified. Underlying the K Seam is a unit of light grey sandstone and siltstone with minor shales and carbonaceous horizons. Most of these carbonaceous horizons are found within about 5m of the base of K Seam.

Marine shales of the Moosebar Formation underlie the Gates Member; however, these rocks will not be exposed in the open pit. Overlying the Gates Member are the Hulcross and Boulder Creek Members of the Commotion Formation. The Hulcross Member, primarily a marine shale, is about 90m thick and is expected to be somewhat less competent



PHOTO 1. Typical interseam shales and siltstones of the Gates Member.



PHOTO 2. Relatively massive conglomerates of the Gates Member stratigraphically above D Seam.



PHOTO 3. Interbedded coals, carbonaceous shales and siltstones of the Gates Member.



PHOTO 4. Typical sandstone and siltstone unit between Seams G and J. Note orthogonal jointing and stepped nature of the rock face.

than the Gates Member. The bulk of the Boulder Creek Member is composed of carbonaceous shales and siltstones with resistant sandstones and conglomerates occurring towards the base. It is anticipated that only a small portion of the southeast wall of the pit, and possibly a small portion of the northeast wall of the pit, will be comprised of Hulcross Member rocks. No Boulder Creek rocks will likely be exposed in the pit.

3.3 STRUCTURAL GEOLOGY

Rational slope stability analysis and slope design requires that the proposed pit be subdivided into areas of similar geologic structural and/or mechanical characteristics. The engineering behaviour of the slope forming materials can be expected to differ in areas of the pit in which the characteristics are appreciably different. In this regard, the proposed pit has been divided into four **Structural Domains** as indicated in Fig. 4. Within each structural domain, the orientation of bedding and joint sets is expected to be relatively consistent.

In sedimentary sequences, the relative spatial orientations of the various discontinuity sets are often fixed with respect to bedding. Thus, discontinuity set orientations may be determined for a given bedding orientation once the spatial relationship between bedding and the discontinuity set is known. To determine the nature of the bedding/discontinuity relationships in the Shikano area, all surface discontinuity data (other than bedding joints) recorded during the field program were stereographically rotated relative to a common bedding orientation. Fig. 5 is a lower hemisphere, equal area projection of poles to all discontinuities relative to a bedding orien-

tation of 000/00*. Despite the limited amount of data available, examination of Fig. 5 indicates that the bulk of discontinuity data falls within two relatively well defined sets, confirming and defining a fixed spatial relationship between bedding and discontinuities. Furthermore, bedding joints (poles to which would plot at the centre of the projection on Fig. 5) form an additional set of discontinuities.

Orientations of geologic structural discontinuities within each structural domain were then assessed by rotating the discontinuity orientation data on Fig. 5 relative to the mean orientation of bedding in each structural domain. Lower hemisphere, equal area projections of poles to discontinuities in each structural domain determined in this manner are included in Appendix B.

3.3.1 Folds

The stratigraphy in the proposed Shikano Pit area has been folded into a northwest-southeast trending syncline and associated anticline, both of which plunge to the southeast at about 15° . The folds are relatively open and slightly asymmetrical. The southern limb of the syncline dips between about 15° and 25° to the northeast, and the northern limb of the syncline (i.e. the southern limb of the anticline) dips to the southwest at between about 40° and 55° (see Figs. 6 to 13). The northern limb of the anticline dips at between about 25° and 38° to the northeast.

* 000/00 refers to dip direction/dip (both in degrees).

3.3.2 Faults

For the Shikano Pit area, the existing geological data indicate the presence of a few moderate to high angle (i.e. 45° to 70°) thrust or reverse faults. As shown on Figs. 6 to 13, these faults seem to be most prevalent near the axis of the syncline and have been interpreted as not penetrating the rock below K Seam to any great extent. Displacement along these faults does not appear to be more than about 10m to 20m in most places.

3.3.3 Bedding and Bedding Joints

As a consequence of the plunging folds, bedding orientations vary widely throughout the pit area. Dip directions range from about 040° to 200° and dips range from essentially flat to about 55° and possibly steeper locally.

Because bedding is a controlling geologic structure at Shikano, a detailed knowledge of bedding orientation is essential for design. An assessment of the variation of bedding dip in proposed walls was accomplished by statistically analyzing bedding dip logged in several diamond drillholes. Drillhole locations are shown on Fig. 3.

Bedding dips measured at regular intervals in drill core were analyzed using the cumulative sums technique developed by Piteau and Russell (1971). The cumulative sums (cusums) technique provides a rapid and precise method of determining the location and magnitude of major trends in bedding dip. These major trends are designated "current mean bedding dips". Details of the construction and interpretation of cusums plots are given in Appendix A.

Current mean bedding dips in each drillhole are summarized on the geotechnical logs in Appendix A and have been used to prepare possible structural interpretations of the geology intersected in each drillhole. These interpretations are shown on the geotechnical sections on Figs. 6 to 12.

Bedding joints occur parallel to bedding and are expected to be relatively continuous. Bedding joint spacing, which has been assessed statistically from diamond drill core logs, varies from about 0.1m for closely interbedded, carbonaceous shales and siltstones, to greater than 4m for relatively massive sandstone and conglomerate units.

3.3.4 Cross Joints

As indicated above, two well defined sets of cross joints have been identified from limited surface geological mapping. In general, these sets are oriented approximately normal to bedding and to each other such that, when combined with bedding joints, they form a roughly orthogonal joint system (see Photo 4). Cross joints are expected to be less continuous than bedding joints, as they are commonly truncated or offset by throughgoing bedding joints.

3.4 ROCK COMPETENCY AND CORE QUALITY

Because slope behaviour is a function of the mechanical properties as well as the geologic structural characteristics of the rock mass, an assessment of the relative rock competency and its variability within the rock mass is also required. In this regard, a statistical assessment of rock mechanics properties logged in the core was carried out using the cumulative sums (cusums) technique described in

Section 3.3.3. Results of this assessment are summarized in Table I and indicate that the rock mass may be divided into four basic units on the basis of stratigraphy, as follows:

- i) **Hanging Wall Rocks (above D Seam)** - These are interbedded shales, siltstones, sandstones and conglomerates of moderate to relatively good quality.
- ii) **Interseam Rocks (D Seam to K Seam, inclusive)** - These rocks are generally interbedded coals, shales, siltstones and fine sandstones with some conglomerate. These rocks are commonly carbonaceous and of relatively poor to moderate quality.
- iii) **Immediate Footwall Rocks** - Rocks within about five metres stratigraphically below the footwall of K Seam tend to be interbedded carbonaceous shales, siltstones and sandstones with occasional coal splits. These rocks are of moderate quality and will form the immediate footwall slopes. Bedding joint spacing within these rocks averages about 0.5m and carbonaceous zones and coal splits may be correlated some distance between drillholes as shown on Fig. 14.
- iv) **Competent Footwall Rocks** - Below about five metres stratigraphically beneath the K Seam footwall, the general rock mass quality increases significantly (see Fig 14). Fine sandstone and siltstone rocks predominate and bedding joint spacing increases to about four metres. These rocks may be classified as relatively good quality rocks.

3.5 ROCK STRENGTH PROPERTIES

3.5.1 Shear Strength of Discontinuities

A knowledge of the shear strength characteristics of the various discontinuity sets is required for slope stability analysis. In this regard, design shear strengths were based on the results of previous studies by Golder Associates (1982a) and on our experience with similar rock masses. For stability analyses involving footwall slope failure mechanisms, bedding joints were assumed to be continuous and cohesionless and to exhibit friction angles of 26° along the more carbonaceous bedding planes within Immediate Footwall Rocks, and 34° within Competent Footwall Rocks. Cross joints, which tend to be slightly rougher than bedding joints, were assumed to have friction angles of 35° and negligible cohesion.

3.5.2 Rock Mass Strength

Certain stability analyses also require a knowledge of the rock mass strength. Based on core logging results and previous studies, the average unconfined compressive strength of Immediate Footwall Rocks and Interseam Rocks is estimated to be 28 MPa (4000 psi). The average unconfined compressive strength for the more Competent Footwall Rocks and Hanging Wall Rocks is estimated at about 60 MPa (8700 psi). Based on these estimated unconfined compressive strengths, and using the method of Hoek and Brown (1980), rock mass strengths were determined for these rock units. Where estimated rock mass strengths have been used in the stability analyses discussed

below, assumed values of friction angle and cohesion are noted on the appropriate reference figures.

3.6 DESCRIPTION OF SURFICIAL SEDIMENTS

Types of surficial sediments encountered across the North, South and Alternate Dump sites are shown on Fig. 15, along with locations of test pits and rotary borings, and descriptions of natural soil exposures. Logs of the test pits excavated for this study are contained in Appendix C. Laboratory classification test results are plotted on the test pit logs. Gradational analyses are contained at the end of Appendix C.

Typical cross sections through the three main dump sites are shown on Figs. 16, 17 and 18. Dump configurations shown on Figs. 16 and 17 for the North and South Dump sites are based on proposed dumping schemes provided by QCL in April and May, 1985 and do not necessarily correspond to the dump configurations indicated on Fig. 15. Dump configurations indicated on Figs. 15 and 18 for the North, South and Alternate Dumps are based on preliminary information provided by QCL in February, 1985 and are intended only to indicate the general extent of the proposed dump sites. Outlines of the expanded North Dump and small Centre Dump indicated on Fig. 15 are based on information provided by QCL in May, 1985.

3.6.1 North Dump and Alternate Dump Sites

A thin blanket of fluvial glacial sand, silty sand and sand and gravel overlies a thin deposit of glacial till, or rests directly on bedrock. The combined thickness of the two deposits is estimated to be generally less than 5m across the North Dump site. At the Alternate Dump site, the overburden

is somewhat thicker, generally exceeding 5m, except on the south side adjacent to the conveyor line, where it thins to the extent that bedrock outcrops are frequent.

Material gradations within the fluvial deposits vary from silty sand to a relatively coarse grained, clean sand and gravel. The deposit ranges from a loose to a dense condition.

The glacial till consists of a well graded mixture of silt, sand, gravel and occasional cobbles, with a trace of clay. The till is essentially plastic. Lenses of silt, as well as sand, gravel and cobbles are encountered within the deposit. Overall, the soil is very stiff, but tends to be somewhat softer near the ground surface, particularly in depressions where there is standing water. Natural moisture contents range between 12 and 28 percent, with the higher moisture contents being observed near the top of the deposit. Below a depth of approximately 3-5m, the till is expected to be quite dense and very stiff to hard.

Pockets of shallow peat are present in depressions within both sites. The peat is generally thin, ranging from about 0.4 to 2.0m thick, although greater thicknesses may occur locally.

The water table is close to, or at the ground surface at both dump sites.

3.6.2 South Dump Site

The surficial geology of the South Dump site is relatively complex. There are at least six distinct deposits within the site, which are described as follows, in order of descending elevation:

a) Colluvium (above approximate elevation 850m)

Colluvium, consisting of a mixture of silt, sand, gravel, cobbles and occasional boulders, is present over the upper part of the site. The deposit is expected to be relatively thin, generally being less than 5m in thickness. Being predominantly coarse grained and relatively dense, this material is anticipated to provide satisfactory support for the dump.

b) Colluvium Over Fluvio-glacial Sand Over Till (between approximate elevations 820m and 850m)

A deposit of fluvio-glacial sand rests on till. The sand deposit is somewhat finer than is observed at the other dump sites described above. However, it is expected to be sufficiently coarse to provide suitable foundation support for the dump.

The till deposit is as described in Section 3.6.1 for the North and Alternate Dump sites.

A thin blanket of colluvium transported from higher levels is also present over parts of this zone. The colluvium is as described above in (a).

c) Lacustrine Silt (between approximate elevations 790m and 820m)

A deposit of fine grained sediments ranging from clayey silt to sandy silt fills a depression in the central part of the dump site. The thickness of the deposit is not known from the test pitting program, but is thought to be in the order of 35m to 45m as interpreted from highly disturbed samples examined from rotary drillholes. The soil is moderately stiff to very stiff, but the strength appears to decrease with depth, as described in Section 6.1.1. Moisture contents range from 20% to 32%. The plasticity index averages 11%, with the liquid limit averaging 28%. Although the soil is predominantly silt in grain size, it would be classified as a clay of low plasticity (CL) according to the Unified Soil Classification system.

The approximate extent of the deposit is indicated on Fig. 15. Because of the significance of this deposit for the design of the dump, additional exploration is recommended to more accurately define its thickness, strength, consolidation characteristics and areal extent as described in Section 6.3.6, for the final dump design.

d) Fluvioglacial Sand to Sand, Gravel and Cobbles (below elevation 790m to 830m)

In the lower part of the dump site and extending to about mid level of the north side of the dump, exists a deposit of relatively coarse grained fluvioglacial sediments. Gradations range from silty sand to sand, gravel and

cobbles. The material varies from moderately dense to dense and is considered to constitute a generally satisfactory foundation medium.

e) Peat (within fluvioglacial deposit)

A thin deposit of peat and organic silt is present in the lower part of the dump site, near the south side (see Fig. 15). Although the deposit is 2.2m thick at the location of Test Pit D, overall, the peat is estimated to average less than 0.5m thick.

f) Alluvium (below approximate elevation 765m to 800m)

Alluvial deposits are present along the flood plain of the Murray River. These deposits are generally below the proposed limit of dumping and, hence, were not investigated for this study. However, test pitting conducted by Golder Associates (1985) indicates that the alluvium consists of a range of sizes from silt to sand, gravel and cobbles.

3.6.3 Centre Dump Site

Detailed investigations of the surficial soils in the vicinity of the Centre Dump site were not carried out. Soils in this area are assumed to be similar to those observed in the North and Alternate Dump sites. This assumption should be confirmed by appropriate field reconnaissance and test pitting prior to placement of any waste material on this site.

4. HYDROGEOLOGY

4.1 REGIONAL HYDROGEOLOGY

The folded structure of the sedimentary rocks common to the Peace River Coal Fields of northeastern B.C., and the well developed system of creeks and rivers which drain the area, tend to limit groundwater flow to local systems. The 200m to 300m stratigraphic thickness of Moosebar and Gething shales should act as a confining layer for any deep regional flow systems under the study area, thereby isolating the Quintette area from significant upward flow from deeper flow systems. Thrust faults present in the area could result in permeable zones through which deep, regional flow groundwaters could discharge to surface. This is unlikely, however, as the underlying shales are relatively soft and have a high clay content, both of which are not conducive to the development of zones of open fractures along faults.

The preferred direction for groundwater flow is parallel to bedding. Groundwater flow across bedding planes is limited by the hydraulic conductivity of the rock normal to bedding, which is generally much lower than the hydraulic conductivity along the bedding planes. This is due in part to the presence of bedding joints, but mainly to the interbedded nature of the rock, in which relatively soft shale and coal strata separate more brittle sandstone and siltstone strata. In the study area, which is characterized by shallow folds, the groundwater flow system should be fairly shallow, reflecting this stratigraphic control.

Most of the shallow geologic structure in the area is relatively small scale with respect to topographic features (e.g., both limbs of a fold are located on the same ridge or in the same valley).

Therefore, groundwater flow along bedding generally discharges relatively close to areas where groundwater recharge occurs.

4.2 PHYSICAL INFLUENCES ON LOCAL HYDROGEOLOGY

The physiography, climate and hydrology of the study area are all factors which must be considered in a discussion of the local groundwater regime.

4.2.1 Physiography

The study area is characterized by high relief. The elevation of the Murray River near the Shikano Pit is approximately 760m. The elevation of Roman Mountain, about 12 Km southeast of the Shikano Pit, is 2000m. Natural slopes in the study area range from nearly flat, to about 35°.

4.2.2 Climate

Average annual precipitation in the catchment area above the Shikano Pit ranges from 600mm/yr to 900mm/yr (Golder Associates, 1982b). The average precipitation over the entire Shikano Pit catchment area is estimated to be 800mm/yr.

4.2.3 Surface Water Hydrology and Infiltration

Surface water drainage in the immediate vicinity of the Shikano Pit is to the northwest via M9, M11 and M13 Creeks. All these creeks empty into the Murray River, which flows to the northeast. Creeks in the area all begin as springs at elevations of 1600m to 1700m (Golder Associates, 1982b).

Low summer flows for M9 Creek in 1981 have been reported as 14 L/s.

A rough estimate of groundwater recharge can be made, by assuming the low measured flow is the base flow, due entirely to groundwater discharge. Based on this assumption, the estimated groundwater recharge rate over the M9 Creek catchment area is 71mm/yr, which is approximately 9% of the average annual precipitation. However, it is likely that the groundwater component of streamflow is higher than the base flow during wet periods of the year, and shortly after the freshet. The actual proportion of precipitation which recharges groundwater flow is, therefore, probably higher than 9%. Fifteen percent of average annual precipitation is generally considered to be a reasonable estimate of the infiltration rate in mountainous areas, and this value has been used for subsequent calculations of groundwater inflow into the proposed Shikano Pit.

4.3 GROUNDWATER FLOW IN SURFICIAL SEDIMENTS

Colluvium and till cover most of the catchment area on the slopes above the proposed Shikano Pit. The thickness of these deposits is expected to be less than 3m, except in small depressions in the bedrock surface.

An estimate of groundwater flow through the surficial sediments into the pit was made, based on the following assumptions:

- i) Surficial sediments are primarily of colluvial origin and have a hydraulic conductivity of 10^{-5} m/s.

- ii) Maximum saturated thickness of surficial sediments is 3m.
- iii) Average slope above the pit is 25%.
- iv) Groundwater flow occurs normal to the strike of the natural slope and discharges along the 1500m width of the pit.

Groundwater flow through surficials into the pit is therefore calculated as:

$$Q = KiA \quad \text{where } K = \text{hydraulic conductivity}$$

$$i = \text{hydraulic gradient}$$

$$= \text{average slope}$$

$$A = \text{cross sectional area}$$

$$Q = 10^{-5} \times .25 \times 3 \times 1500$$

$$= 11 \text{ L/s}$$

The 11 L/s estimate for groundwater flow through the surficial soils is an upper bound estimate, as glacial till in the area would have a lower hydraulic conductivity, and the presence of two valleys draining the area would probably result in nearly dry surficial sediments on the ridges between the valleys. Also, some of the estimated groundwater flow through the surficial sediments would probably be intercepted by the diversion of M11 Creek, and would not enter the pit. Hence, a more realistic upper bound estimate for inflow from the surficial sediments into the pit is 8 L/s. That is, about 30% of the total estimated flow is assumed to be intercepted by the M11 diversion.

4.4 GROUNDWATER FLOW THROUGH BEDROCK

In order to quantitatively evaluate the flow of groundwater through bedrock, estimates of the hydrogeological properties of the rock mass must be made. These estimates, along with interpreted groundwater flow systems, are discussed below.

4.4.1 Hydrogeological Properties

Based on the stratigraphy, the rock mass at the Shikano Pit can be subdivided into three hydrogeological units, as follows:

- i) Hanging wall rocks (above D seam)
- ii) Interseam rocks (D seam to approximately 5m below K seam, inclusive)
- iii) Footwall rocks

Hanging wall and footwall rock are similar in that they contain high proportions of siltstones and sandstones.

Interseam rocks also contain some siltstone and sandstone, but also consist of numerous strata of coal, shale and carbonaceous shale. Interseam rocks are also generally more fractured than either footwall or hanging wall rocks.

The hydrogeological properties of footwall and hanging wall rocks are likely to be different from interseam rocks. Footwall and hanging wall rocks are generally more competent and are expected to be less fractured on the fold limbs than interseam rocks. However, they should be more fractured, and therefore more permeable, along the fold axes.

The bedded structure of the rock in the mine area should result in a high degree of anisotropy in the rock mass, which will have a great effect on groundwater flow systems. Because this anisotropy is common to all rocks in the area and because relatively little data are available for the hanging wall and footwall rocks, hydrogeologic modelling has been based on one hydrogeologic unit, having a high degree of anisotropy and a range of hydraulic conductivities. The range of hydraulic conductivities accounts for different intensities of fracturing in the various rock units.

Hydraulic conductivity for the rock mass was estimated from falling head tests performed in piezometers installed in drillholes in the area. The results of falling head tests performed in twenty-three piezometers in the study area are summarized in Table II. A few of the hydraulic conductivity values estimated from falling head tests were less than 10^{-9} m/s, but the majority of values were between 5×10^{-9} m/s and 5×10^{-7} m/s. Falling head tests in ten piezometers installed on Babcock Mountain indicate a range in permeability of 10^{-8} m/s to 10^{-6} m/s for the coal and interbeds (Golder Associates, 1982b). One test, performed in the Hulcross shale, resulted in a hydraulic conductivity of 1×10^{-6} m/s.

Falling head tests generally provide a low estimate of rock mass permeability. This is due partly to the detrimental effects of drilling on the permeability of the rock forming the walls of the drillhole and partly because falling head tests are small scale. Many test zones may not intersect open fractures or bedding planes, resulting in a low estimate of hydraulic conductivity. These low hydraulic conductivity

values are not necessarily indicative of the overall permeability of a fractured rock mass. For example, an extensive open fracture can greatly increase the effective permeability of an otherwise tight or competent rock mass.

A reasonable estimate for the range of hydraulic conductivities of a rock mass should generally fall in the upper portion of the range determined from falling head tests. Hence, based on tests conducted in both the Shikano and Babcock Pit areas, the rock mass hydraulic conductivity in the Shikano Pit area is expected to range between 5×10^{-8} m/s and 10^{-6} m/s. This range is for hydraulic conductivity parallel to bedding. As discussed above, sedimentary rocks are usually anisotropic to some degree (i.e., hydraulic conductivity along bedding (K_h) is greater than hydraulic conductivity across bedding (K_v). Fractures perpendicular to bedding rarely extend over more than a few strata, resulting in a relatively low hydraulic conductivity in this direction. The anisotropy (K_h/K_v) of the rock mass in the study area is expected to range between 10 and 30. Some modelling, however, was carried out assuming an anisotropy of only 3 for worst case inflow conditions.

4.4.2 Groundwater Flow System

Water levels measured in piezometers in the Shikano Pit area are summarized in Table II. With the exceptions of QBD 84001 and QBR 84004, all monitoring holes show a downward (i.e. recharge) gradient, despite being located at the base of Babcock Mountain. These gradients, which are across bedding, are generally quite high, ranging from about 8% to 43%, and are illustrated by the sometimes dramatic variations in

piezometric levels measured in piezometers and shown on the sections in Figs. 6 to 13. Hydraulic gradient along bedding is generally much less, as evidenced by the 3% gradient between holes QBD 8205 and QBD 8212, shown on Fig. 13.

The above gradients are indicative of a stratigraphically controlled groundwater flow system in which most groundwater flow occurs along bedding, with only limited flow downwards, across bedding. The high downward gradient is also due to the varying elevation at which strata subcrop in the valley. Groundwater will discharge from the strata where they subcrop. Thus the elevation of the subcrop defines the head of groundwater discharge. Because of the high anisotropy, the hydraulic head at any point along the flow system is more closely related to the elevation of groundwater discharge from the particular stratum in which the groundwater is flowing, than to the hydraulic head in adjacent strata.

Anisotropy in the rock mass will limit the areal effect of pit development on local groundwater flow systems, thus limiting the rate of groundwater inflow into the pit. Rather than one large flow system in a homogeneous rock mass discharging into the pit, only flow in strata which daylight in the pit, or immediately adjacent strata will discharge into the pit.

4.5 STEADY-STATE COMPUTER MODELLING OF GROUNDWATER FLOW

A steady-state, finite-element computer model was used to model both existing and post mining groundwater flow. The purpose of the modelling exercise was to predict the probable range of groundwater conditions in the Shikano Pit, based on the range of hydrogeologic

properties discussed above. Modelling was carried out using a Hewlett Packard 9845B desktop computer.

Two sections were analyzed with the steady-state model, one along the synclinal axis which runs through the Shikano Pit (see Fig. 13), and one along Section 23800, perpendicular to the fold axes (see Fig. 8). The purpose of modelling a section along the synclinal axis was to determine the range of expected groundwater inflows from the catchment area above the Shikano Pit, and to estimate the degree of drainage which should occur naturally in the end walls at the southeast end of the pit. The purpose of modelling Section 23800 was to estimate pore pressure distributions behind the hanging wall slope along the northeast wall of the pit (Design Sectors V and VI) and behind the unbenched footwall slopes on the southwest wall and along the ridge which will be developed in the middle of the pit.*

4.5.1 Modelling Along Synclinal Axis

The finite element mesh was based on the section shown in Fig. 13, and was extended up the M11 Creek Valley to the 1600m elevation. The constructed mesh, and range of material properties assumed for the modelling are shown in Fig. 19. Initially, the premining situation was modelled.

Discharge to the surface was computed for each case modelled, and then compared to estimates for base flow in M11 Creek. Equipotential plots for selected runs and tabulated results for all runs are presented in Fig. 19. Modelling of the pre-

* Design Sectors are defined in Section 5.

mining situation indicates that the average hydraulic conductivity of the rock mass is close to 10^{-7} m/s, and that the anisotropy is likely to be 10 or greater. If the hydraulic conductivity were closer to 10^{-6} m/s, the base flow in M11 Creek would probably be much greater than the estimated baseflow. If the anisotropy were much less than 10, vertical hydraulic gradients would be very low, which is not the case, based on piezometric levels recorded in the field.

All the cases modelled indicate that a large proportion of the groundwater flow discharges into the drainage basin at fairly high elevations. Based on the modelling, less than 20% of the groundwater discharge occurs below the 1000m elevation.

Once the premining modelling was completed, the mesh was modified to account for excavation of the pit, and the model was run for the two "best fit" cases. The mesh used for this predictive modelling, and material properties used for the two cases which were run, are shown on Fig. 20. Computed steady-state inflows to the pit ranged from about 25% of the total discharge on the section modelled for the case where anisotropy equals 30, to 38% for the case where anisotropy equals 10. Based on these results, an upper bound steady-state groundwater flow into the pit was estimated to be 40% of the total groundwater discharge to the M11 drainage basin.

The post mining position of the water table behind the southeast wall of the pit was also estimated during the predictive modelling. Computed water table positions for the two cases modelled are shown on Fig. 13 along with the present water table position.

4.5.2 Modelling Along Section 23800

The mesh constructed for modelling along Section 23800 is shown in Fig. 21.

The two cases which were run assumed a hydraulic conductivity of 10^{-7} m/s parallel to bedding. Anisotropy of 10 was assumed for Case I, and anisotropy of 30 was assumed for Case II. Equipotential plots and tabulated results for both cases modelled are presented in Fig. 21.

4.6 GROUNDWATER INFLOWS TO THE PIT

Estimates of groundwater inflows to the pit were based on results of the computer modelling, volume calculations of water removed from storage in the rock mass around the pit, and water balance calculations.

The catchment area above the Shikano Pit is approximately 11 Km². This area is substantially larger than the catchment area for the M11 Creek, because some recharge to flow systems intercepted by the Shikano Pit may be recharged from precipitation in the M9 and M13 Creek drainage basins. Total precipitation recharge to this area is:

$$Q = \frac{800\text{mm} \times 15\% \text{ infiltration} \times 11 \text{ km}^2}{\text{year}}$$

$$= 42 \text{ L/s}$$

Based on modelling results, an estimated 40% of this groundwater recharge (approximately 17 L/s) would discharge into the pit. The remaining 60% of the groundwater recharge would eventually become surface flow in M11 Creek, above the Shikano Pit, or discharge directly into the Murray River Valley.

Estimates of groundwater inflow from the northeast and southwest walls of the pit were obtained from modelling Section 23800. The computed flow from these two walls totals 3.6×10^{-3} L/s/m of wall length for the worst case (i.e., anisotropy equal to 10) modelled. Multiplying this value by 600m (approximate length of wall relevant to modelling) yields an estimated inflow of 2 L/s from these two walls.

Groundwater flow from the Murray River towards the pit should be minimal. Modelling indicates that there will still be a net discharge at the river. Thus inflow from the river is assumed to be zero.

All the above groundwater inflows are for steady-state conditions. There will also be a transient response to mining. This will involve removal of water from storage in the rock mass around the mine. An estimate of the water removed from storage was made by calculating the area dewatered on the modelled sections, converting this to a volume based on a 3% porosity, and extrapolating these volumes around the circumference of the pit. These volume calculations are summarized below:

extent of drawdown behind slope	= 600m
average drawdown	= 35m
area dewatered	= 18000 m ³ /m
perimeter of pit over which area is weighted	= 3000m
volume dewatered	= 5.4×10^7 m ³
volume of water removed (3% porosity)	= 1.6×10^6 m ³

Assuming most of the dewatering occurs during the last year of mining, the average groundwater inflow due to release of water from storage is 51 L/s.

Groundwater inflow to the Shikano Pit will peak during the last year of mining, primarily due to release of groundwater from storage. The estimated average groundwater inflow to the Shikano Pit during the last year is the sum of the inflows discussed above. Thus, the estimated inflow is:

Steady-state inflow due to precipitation recharge on catchment area above pit	17 L/s
Steady-state inflow from northeast and southwest walls	2 L/s
Stead-state inflow from Murray River	0 L/s
Transient inflow due to release of groundwater from storage during last year of mining	51 L/s
Groundwater inflow from surficial sediments	<u>8 L/s</u>
Estimated Total Groundwater Inflow	78 L/s

During the early phases of mining, groundwater inflows would be significantly less than this value. As the estimated 78 L/s groundwater inflow to the pit during the last year of mining is based on a number of assumptions, a range of $\pm 30\%$ should be allowed for in assessing sump and pumping requirements and in the design of settling ponds which would receive this water.

4.7 GROUNDWATER CONDITIONS BEHIND THE PIT SLOPES

The computed positions of the water table behind the pit slopes have been shown on the sections modelled (see Figs. 8 and 13). The modelling indicates that all slopes should be moderately drained and should not require any remedial dewatering. However, two conditions not considered by the modelling could adversely affect the groundwater conditions behind certain slopes.

4.7.1 Recharge from the M11 Creek Valley

Groundwater recharge to strata behind the southeast wall (Design Sectors I, IIA and IIB) could occur due to leakage from the M11 Creek Diversion, or from groundwater flow in the surficial sediments which is not intercepted by the diversion structure. Some recharge is acceptable, but if it amounts to more than a few litres per second, it would result in a much higher phreatic surface behind the southeast wall in the immediate vicinity of the M11 Creek Valley than indicated by the modelling. The M11 Creek Diversion should therefore be designed to limit leakage. A piezometer nest should also be maintained in this area to monitor the pore pressure distribution behind this wall. The existing piezometers in QBD 82005 are suitably located to monitor the deeper strata in this wall, but a short hole should be drilled in the M11 Creek Valley to allow installation of piezometers in the hanging wall rock.

4.7.2 Recharge Behind Southwest and Northeast Walls

The computer modelling considered only minimal recharge behind the southwest footwall slope (Design Sector IX), and northeast hanging wall slope (Design Sectors V and VI). Natural groundwater flow from Babcock Mountain towards the Murray River could have an effect on the groundwater conditions behind these walls. This effect should be minimal in the northeast wall, as all the strata daylight in the pit, which should promote drainage. The southwest wall, however, is an unbenched footwall in which bedding is parallel to the slope face. This orientation severely restricts the flow of groundwater from the slope, thus making the groundwater con-

ditions behind this wall very sensitive to changes in recharge. The worst case would be that very little reduction in the pore pressures in this slope occurs as a result of mining. If this situation does occur, some remedial measures would be required to reduce pore pressures behind this slope. Monitoring of piezometric levels in the footwall will be required during mining, so that groundwater conditions and their effect on the stability of the footwall slope can be assessed as the slope is developed.

The zone of major concern for the southwest slope, and hence, the target of the monitoring, is the 40m stratigraphically below the footwall of K Seam. A monitoring hole located behind the footwall slope on Section 23400, could be inclined slightly to allow installation of a piezometer in the footwall rock at an elevation of approximately 830m. Monitoring data from this proposed hole, coupled with data from QBD 8205, should allow an accurate assessment of depressurization which occurs behind the footwall slope.

4.8 MONITORING

Areas which require monitoring, and recommended monitoring installations have been discussed above. All piezometers which are present in the pit area should be monitored on a monthly basis starting from the present, and continuing until the pit is completed. This should include piezometers in the pit area, which can be monitored until they are destroyed by the excavation. Every effort should be made to preserve the piezometer installation in QBD 8205. The two deep piezometers in this hole are ideally located to monitor both the southeast wall, and the southwest footwall. The installation in QSR 85001, located just outside the east corner of the proposed pit, should also be preserved, if possible.

If monitoring data indicates that groundwater conditions are adversely affecting stability of the slope, dewatering measures may be required. These measures are discussed in Section 5.3.5.

5. SLOPE STABILITY ANALYSES AND DESIGN

Based on the location of structural domains and the orientations of proposed slopes, the ultimate pit has been divided into eleven **Design Sectors**, within which both the structural geology and general slope orientation are expected to be relatively constant (see Fig. 4). On the basis of these eleven design sectors, the proposed slopes may be subdivided into two basically different slope types: footwall slopes, which are excavated parallel or sub-parallel to bedding; and hanging wall or endwall slopes, which are excavated oblique or normal to the strike of bedding. Each of these slope types require fundamentally different stability analysis and slope design approaches and, hence, are discussed separately in the following.

5.1 FOOTWALL SLOPES (DESIGN SECTORS VII, VIII AND IX)

Based on the current geologic interpretation and on bedding dip information available from drill core, bedding dip on proposed footwall slopes is expected to vary from essentially horizontal to a maximum of about 55° . For the range of bedding dips and slope heights envisaged, and given the relatively favourable orientation of discontinuities with respect to footwall slope stability (neglecting possible unfavourably oriented faults), two basic modes of failure are expected to control footwall slope stability. These failure modes, Plane Failure and Bilinear Slab Failure, are discussed below.

5.1.1 Plane Failure

Plane failure is kinematically possible wherever structural discontinuities occur which strike subparallel ($\pm 20^{\circ}$) to the slope and dip out of the slope. Examination of surface

discontinuity mapping data indicates that simple plane failures are not expected to be of significant concern on footwall slopes, unless bedding is undercut. Design guidelines are given below for areas where it may be necessary to undercut bedding.

5.1.2 Bilinear Slab Failures

Failures of this type generally require the presence of continuous bedding joints and a flat lying discontinuity which strikes approximately parallel to the slope and dips more shallowly than bedding on footwall slopes. Examination of surface discontinuity mapping data and the kinematic plots indicates no such joint set exists with this orientation. However, because it is possible that high slopes could be developed in a relatively fractured rock mass, the potential for a failure plane to be developed partially through the rock mass in the toe of the slope was investigated.

The analysis carried out is based on limit equilibrium techniques. Strength parameters assumed for the rock mass were determined as described in Section 3.5. Simple friction was assumed to act on bedding planes. Analysis results are presented in terms of maximum allowable unbenched slope height for a given dip of bedding. It is noteworthy that the bilinear slab failure analysis assumes that the slope is planar and completely drained. Actually, the footwall slopes will often be curved and possibly not completely drained. Such conditions could significantly reduce the calculated factors of safety of the slope. Results of analyses assuming true spacings of continuous bedding joints of 0.5m and 4m, which are considered representative of Immediate Footwall Rocks and

Competent Footwall Rocks, are given in Figs. 22 and 23, respectively. Results assuming a bedding joint spacing of 1.0m for Competent Footwall Rocks are also given for comparison in Fig. 23.

5.1.3 Footwall Slope Design Guidelines

Guidelines for maximum bench heights for slopes deemed to be controlled by bilinear slab failures are indicated in Figs. 22 and 23, and Table III. These guidelines are based on the results of the above analysis, familiarity with rock mass conditions from surface exposures and diamond drilling, operational considerations concerning bench heights in multiples of 15m, and our experience with similar situations in the McConkey and other coal mines.

The footwall slope design guidelines relate rock mass type, structural geological conditions and pit slope orientation. That is, based on estimated bedding orientation, joint spacing, rock type, wall orientation, and bench height increment, an appropriate design can be chosen from the charts and tables presented. It is intended that these guidelines can be used to update the pit design in specific areas in the pit if future geological interpretations are significantly different than the existing interpretation.

Because of the differences in rock mass quality between Immediate Footwall Rocks and Competent Footwall Rocks, two sets of slope design criteria have been specified in Figs. 22 and 23 and Table III. It should be noted that, for slab failure considerations, usually only one bench would be required in Immediate Footwall Rocks, and this would most probably be near the toe of the slope.

Design guidelines given in Figs. 22 and 23 and Table III refer to bedding dip ranges or maximum bedding dips. Where a maximum bedding dip is specified, the given design may be applied for any bedding dip less than or equal to the maximum value given. For example, in the dip range where a 30m high interval between berms is acceptable, 15m intervals would also be safe, but 45m would be unsatisfactory. In this case, the choice between single or double benches (i.e. 15m vs. 30m) would be based on operational considerations and slope geometry required for stability on adjacent sections.

An example of how the information presented here might be applied is given in Fig. 24. Initially, a pit bottom must be chosen on section. This decision is usually based on coal seam geometry and economics. The slope design is begun at this point and developed upwards. The geometry and rock mass conditions are assessed and a suitable slope design chosen from Table III. This design is projected upwards for as far as conditions remain appropriate to the chosen slope geometry. When a point is reached where conditions have changed significantly, a new design must be chosen for the next slope segment. This process is repeated on all geologic sections along the slope until the slope design reaches surface. Differences or inconsistencies in design between adjacent sections must be resolved by blending (gradually changing from one design to the next), or by choosing the more conservative design. Operational aspects must also be taken into consideration to arrive at an efficient and practical slope geometry.

5.2 HANGING WALL AND ENDWALL SLOPES (DESIGN SECTORS I TO VI)

To identify kinematically possible failures (involving discontinuity sets) which could substantially affect stability, kinematic assessments were carried out for each potential hanging wall and end-wall slope. In all cases, plane and/or wedge failures involving various combinations of cross joints were identified as the failure mechanism considered to control bench stability.

Because of the interbedded nature of many of the the rock units at Shikano and the relative lack of continuity of cross joints, wedge and plane failures (other than plane failures along bedding) are expected to be limited by, or "stepped" between, continuous bedding or cross joints. This mechanism is illustrated on Fig. 25 and Photo 4.

Based on the type and apparent plunge or dip of the failure considered to control bench stability, alternative bench designs were considered for 15m and 30m high benches and for bench face angles of 70° , 80° and 90° . These alternative designs were evaluated in conjunction with assessments of minimum berm width required for access and other operational considerations, to select the optimum slope design to accommodate the occurrence of wedge and plane failures. Recommended slope designs for the various design sectors are summarized in Table III. Anticipated breakback of bench crests, resulting effective bench face angle, total design berm width and intermediate slope angles summarized in Table III have been calculated according to the definitions given on Fig. 25. Because of the "stepped" nature of controlling wedge and plane failures, anticipated breakbacks summarized in Table III are equivalent to one-half the possible breakback for throughgoing failures.

It should be noted that although eight different design sectors involving endwalls and hanging walls are indicated on Fig. 4, several of these have been considered together for practical design purposes. As a result, the number of unique endwall and hanging wall slope designs has been reduced to three as summarized in Table III.

5.3 GENERAL SLOPE DESIGN RECOMMENDATIONS

In addition to the specific design guidelines related to slope geometry given above in Sections 5.1 and 5.2, the following general slope design recommendations are provided.

5.3.1 Blending and Modification of Recommended Slope Designs for Pit Planning Purposes

Recommended slope designs are based on analysis of information within the design sector where the design is applied and on the overall slope, with little consideration given to pit planning requirements or designs for adjacent design sectors. Design of the final pit slopes must include zones of transition between adjacent design sectors. In general, the recommended intermediate slope angles for a design sector should not be exceeded in transition zones. However, it may be feasible to steepen slopes over small sections of the slope and accept the possibility of increased failures on a trial basis.

5.3.2 Final Wall Blasting, Blasting Trials and Ripping

Design of final wall blasts should be evaluated and trial blasting should be carried out to determine the optimum methods required to control breakback on benches. Final wall

blasting must be designed to maintain cohesion of the rock mass and prevent long term rockfall hazards from developing on benches. The objective of the blasting design is to eliminate rockfall hazards and bench failures by scaling and cleanup during mining so that after the berm has been established, relatively few rockfalls or failures will occur on the benches.

Blasting damage to final benches could be minimized by eliminating subgrade drilling and laying out blast holes to span the bench crests.

Ripping, or some other non-explosive technique, should be used to excavate coal next to final walls, particularly on footwall slopes excavated parallel to bedding. Ripping trials should be carried out in representative sections of the slope in areas of highly broken or sheared rock to assess the feasibility of this practice for developing final slopes. Excavation by ripping without blasting would have the effect of maintaining the maximum possible cohesion in the rock mass.

5.3.3 Artificial Support and Related Remedial Measures

If it becomes apparent that controlled blasting is not adequate to achieve the degree of stability required, some form of artificial support or rockfall protection measures might be required on strategic benches (such as on the Southwest Footwall Ramp as discussed below in Section 5.4, and on the beaches immediately above and below the Mill Creek Diversion) or in other areas to protect critical installations. Stabilization could be provided by rock bolts installed across critical failure surfaces.

Other simple forms of stabilization, such as the use of vertical dowels, consisting of old drill steel, track, bars, H-beams, etc. grouted into holes drilled with a production drill, may also be beneficial in some areas. Rockfall protection measures, such as catchments, draped mesh, etc., may also be useful in specific areas, most particularly on some high footwall slopes.

5.3.4 *Cleaning Berms and Scaling*

All benches must be thoroughly scaled and debris cleaned from berms during excavation. Berms must be kept reasonably clean of debris to remain effective as rockfall catchments. Cleaning berms will be particularly important on hanging walls and end walls where it is anticipated that significant raveling may occur.

5.3.5 *Groundwater Monitoring and Control*

Monitoring of piezometric levels in all major slopes should be carried out periodically. Existing piezometers should be monitored on a monthly basis, both prior to and during mining operations. Pre-mining monitoring will provide a seasonally adjusted baseline from which the effects of excavation can be assessed.

After development of final walls commences and preliminary monitoring data are available, groundwater control measures can be installed as required. This may be particularly important in the case of the southwestern footwall slope (Design Sector IX). If monitoring indicates high piezometric levels are being maintained behind this footwall slope,

shallow vertical relief wells may be required. These could be drilled with a blasthole rig.

5.3.6 Control of Surface Water

The main source of surface water inflow to the pit will be in the M11 Creek Valley. A surface water diversion proposed for the M11 Creek will conduct the majority of the surface water in this valley to the Murray River. The proposed alignment for this diversion is along a wide berm near the crest of the pit wall. In order to minimize groundwater recharge to the slopes in this area, the diversion ditch should be lined to prevent leakage which would ultimately infiltrate into the rock. Design of the diversion ditch should also address the shallow groundwater flow in the coarse sediments in the bottom of the valley. The diversion structure should either be excavated into the sediments, so that the shallow groundwater flow is intercepted, or a cutoff should be installed to direct this groundwater flow into the diversion channel.

5.3.7 Trial Slopes

Trial slopes, consisting of higher benches, steeper bench face angles and/or narrower berms, could be incorporated into the slope on a trial basis with due consideration of the operational constraints and ramifications resulting from unsatisfactory trials. Results of monitoring of trial areas would be useful for verifying final slope designs.

5.3.8 Monitoring Slope Movement

Slope movements in open pit mining operations can usually be dealt with in such a way that operations can be effectively continued with little or no loss in production rates. It is most important that slope instability be noted at the earliest possible time so that, if necessary, plans may be altered without disruption of the mining process.

If slope movements are detected, it is most important to monitor displacements and to determine the type, geometry, cause, and rate and direction of movement. While continuous, slow displacement of a slope may not suggest imminent danger of complete failure, appropriate movement monitoring will indicate accelerations which usually precede failure. When such accelerations are noted, implementation of immediate, previously planned remedial action may prevent or delay failure.

At Shikano periodic visual inspections of all pit slopes should be conducted as a means of first identifying potential areas of slope movement. In addition, a system of movement monitoring should be immediately established in all walls where slope failures could adversely affect mine production or operations, such as in the immediate vicinity of the M11 Creek Diversion on the southeast wall. A series of movement monitoring "hubs" or survey benchmarks should be established on selected benches at an initial spacing of about 50m to 100m. Hubs should be monitored and results plotted and evaluated at least twice each month. Movements should be plotted in terms of vertical movement, total movement and movement rate. If slope movements are detected, monitoring

frequency and the number of hubs should be increased and appropriate remedial measures such as groundwater depressurization, slope flattening, buttressing, etc. should be considered, if necessary.

5.3.9 Further Geotechnical Work

In addition to the groundwater and movement monitoring discussed above, all slopes should be mapped and documented during excavation. The mapping and slope documentation information should be used to update the geologic data base and geotechnical parameters and to reassess the slope designs on an ongoing basis. The ongoing geotechnical mapping should consist of regular structural mapping of newly exposed benches. All data should be assessed with respect to the spatial relationship between the various joint sets to determine if the spatial relationship assumed in this report remains valid throughout the mine. Slope documentation, consisting of the recording of such parameters as bench face angle, bench heights, breakback, berm width, amount of raveling, etc., should be evaluated with respect to the expected behaviour of the slopes for any given design.

Particular attention should be given to identifying faults or other unfavourably oriented structures, such as bedding rolls on footwall slopes or discontinuities which are undercut on footwall slopes. Early identification of such features will allow for proper planning and implementation of remedial measures as required.

5.3.10 Snow Avalanche Problems

The potential for snow buildups and related avalanche problems is difficult to assess in the absence of detailed meteorological data. The buildup of snow on slopes depends primarily on the type and amount of snow, direction of the slope and prevailing wind conditions. The behaviour of the slopes in the initial years of mining will provide an indication of the potential for snow buildups. It is important to recognize that, in extreme cases, snow related problems could require significant remedial measures, modification to the slope geometry, etc. to control such hazards.

5.4 DESIGN RECOMMENDATIONS FOR SOUTHWEST FOOTWALL RAMP

It has been proposed to excavate a ramp across the southwest wall of the open pit in Design Sector IX. The proposed ramp would traverse the slope from an elevation of approximately 815m at the west end to 740m (pit bottom) at the east end of the wall.

Construction of this ramp would require undercutting of bedding along its entire length. Based on the most recent geological interpretation provided by Quintette Coal Limited, bedding dips in the area range from 12° to 15° at the west end to about 25° at the east end. The excavation would cut through Immediate Footwall Rocks and into Competent Footwall Rocks (see Fig. 26).

5.4.1 Stability Analysis Relating to Undercut Bedding Above Ramp

Design guidelines require that Immediate Footwall Rocks should not be undercut where bedding dips exceed 20° .

Stability analyses for the slopes above the proposed ramp

indicate that a very extensive remedial support program could be required to ensure an adequate factor of safety against plane failure on bedding planes in Immediate Footwall Rocks. Plane failure in Competent Footwall Rocks for bedding dips up to 30° is considered unlikely, assuming dry or depressurized groundwater conditions.

It is noteworthy that the plane failure stability analysis assumes that a completely continuous and regular planar discontinuity exists, that strength parameters along it do not vary, and that the slope is drained or dry. In reality, bedding joints are typically undulatory and somewhat rougher than laboratory sized samples, may have cementitious material along them which would afford some cohesion, and are commonly not continuous for the entire length and breadth of the slope. All of these conditions usually contribute to greater stability of the slope. On the other hand, groundwater pressures may exist in the slope, to the detriment of stability. However, overall it is felt that the analysis results are generally conservative.

The section of the proposed ramp which would undercut bedding dipping more steeply than 20° occurs near the bottom of the ultimate pit, at the east end of the slope. It appears that this part of the ramp (i.e. the portion of the ramp below about 1770m elevation) would be required for a relatively short period of time near the end of mining. On this basis, and because of the apparent conservative nature of the stability analyses, it is felt that it may be possible to excavate the proposed ramp with no or only limited remedial support.

5.4.2 Slope Design for Southwest Footwall Ramp

Where bedding dips are less than 20° , it is recommended that a single back slope with no benches be cut at 60° . This would result in a maximum back slope height of about 15m (see Fig. 26).

For the lower section of the road, where bedding dips are expected to be between 20° and 25° , an excavated slope utilizing an intermediate bench is recommended. The upper bench would be cut mostly in Immediate Footwall Rocks with a bench face angle of 60° and a berm width of 10m (see Fig. 26). The lower bench is expected to be almost entirely in Competent Footwall Rocks and should be excavated with a bench face or back slope angle of 70° .

Provided that adequate drainage is maintained as discussed below, and that bedding dips in excess of 25° do not occur, large scale plane failures involving substantial portions of the slope are considered unlikely. However, where bedding dips between 20° and 25° , occasional small scale plane failures involving undercut Immediate Footwall Rocks could occur which may or may not be controlled on the intermediate catchment bench. In this regard, wherever an undercut slope is to be established and bedding dips steeper than 20° , 1 or 2 rows of 7 to 8m long, fully grouted, untensioned, steel dowels may be required at 5-10m intervals along the crest of the undercut slope as indicated in Fig. 2b. Exact dowel requirements, including type, number, spacing, length, inclination, etc., would best be determined via field trials. In addition, to maintain as much bedding plane strength as possible it is recommended that any dowels should be

installed prior to undercutting the relevant section of the slope.

In all cases, a catch ditch should be incorporated in the design to trap material rolling off the undercut slopes. Some raveling of these slopes is expected and the ditch would prevent broken rock from disrupting traffic on the ramp.

Access should be maintained to the berm above the ramp, as periodic clearing of accumulated debris may be required.

5.4.3 Special Considerations for the Southwest Footwall Ramp

In all cases where bedding is to be undercut, careful controlled blasting is mandatory in order to avoid damaging the rock mass behind the intended slope face. It is recommended that a drill rig capable of drilling angled holes parallel to the intended face be used and that blasts be designed with closely spaced holes and light charges per delay.

To ensure stability of the undercut footwall slopes, it may be necessary to control groundwater pressures. Analysis has indicated that groundwater pressures in the southwest wall (Design Sector IX) may not be affected significantly by excavation of the pit. Therefore, it may be necessary to effect drawdown by the use of vertical pressure relief holes on slopes above the proposed ramp. The spacing and depth of relief holes would be determined by trial during excavation of the pit by monitoring piezometric changes in response to mining.

A slope movement monitoring system is recommended for all slopes where bedding dipping more steeply than 20° is to be undercut. Survey prisms mounted on the slope at regular intervals, combined with visual monitoring for signs of deterioration are recommended. Monitoring should be carried out at regular intervals (approximately once per week) as well as during and/or after significant events such as blasts, substantial rainfall, spring thaw, etc.

6. WASTE DUMP DESIGN

It is understood that QCL proposes to construct the waste dumps in a series of lifts as indicated in Figs. 16, 17 and 18. Dump configurations indicated in Figs. 16 and 17 for the South and North Dumps, respectively, are based on proposed dumping schemes provided by QCL in April and May, 1985. The configuration for the Alternate Dump indicated on Fig. 18 is based on preliminary information provided by QCL in February, 1985.

According to proposed plans, the South Dump could commence at the 860m level in 1986. This berm would be extended downslope in 1987 and an over-dump would be constructed up slope from elevation 890m. As the dump progresses down slope, successive berms would be formed at elevations 830m and 800m. Eventually the elevation 830m berm would be extended over the elevation 800m berm until the dump limit is reached in 1989.

The bulk of the North and Alternate Dumps would be constructed in one or two lifts to maximum elevations of 920m and 890m, respectively. In the case of the North Dump site, an option of constructing a single extended dump at this location is also under consideration. The extended dump would be constructed to the approximate limits shown on Figs. 15 and 16 to an elevation of 1015m.

In addition, it is understood that construction of a small dump, referred to as the Centre Dump, is proposed for the area between the North and South Sub-pits indicated on Fig. 15. This dump would apparently be not more than about 30m high.

The stability of the waste dumps will be controlled by the strength of the surficial soils and bedrock materials on which the dumps will rest. Bedrock would constitute an adequate supporting medium for waste dumps constructed

at the proposed configurations and heights. However, the capability of the soil overburden to support the individual waste dumps is limited, as discussed in the following sections.

6.1 MATERIAL AND GROUNDWATER ASSUMPTIONS

The parameters adopted in the analysis of stability of the waste dumps are presented in the following:

6.1.1 Soil Overburden and Waste Rock

a) Peat and Organic Silt

Peat and organic silt form a mantle on the wetland areas, the materials exhibiting negligible strength. In the following analyses, it is assumed that all organics greater than 150mm in thickness are removed.

b) Colluvium

A friction angle (ϕ) of 30° was adopted for colluvium overlying bedrock, as well as re-worked till at the ground surface. This is considered to be a lower bound for friction strength of colluvial soils.

c) Glacial Till

0 - 5 m: The upper 2 - 5 m of the till deposit tends to be relatively wet and softer than the underlying material. Initially, until it has had time to consolidate, it may develop high pore pressures. Therefore, it should be treated as a cohesive material under the

load of the initial lift. An undrained shear strength of 100 kPa was used in the stability analysis for the first lift. For the second lift, it was assumed that some strength gain occurred from consolidation, increasing the undrained strength to 150 kPa. In the case of the extended North Dump, where additional lifts will be added, it was assumed that the till would be fully consolidated by the time these lifts are placed and, hence, drained strength parameters are applicable ($\phi = 35^\circ$).

Below 5m: The glacial till below a depth of approximately 5m is expected to be very dense and will tend to dilate upon shearing. Thus, any pore pressure increase following placement of the dump is likely to be small. A friction angle of 35° is considered to be a suitable lower bound value for use in stability analyses, assuming drained conditions.

d) Fluvial Deposits

The gradation of the fluvial material is relatively coarse. Hence, a friction angle of 32° was adopted for use in the stability analyses.

e) Lacustrine Silt

The deposit of lacustrine silt located in part of the south dump site is relatively soft. From pocket penetrometer and torvane tests, the undrained shear strength is estimated to be 50 kPa, or more. The possibility cannot be ruled out, however, that weaker material exists below

the depth of sampling in the test pits. Therefore, a strength of 50 kPa is not necessarily conservative in this analysis.

f) Waste Rock

Based on the gradational characteristics, the repose angle of waste rock being placed in the existing dumps and experience from other coal waste dumps in the Rocky Mountains region, a minimum friction angle of 37° is considered to be applicable to the waste rock.

6.1.2 Bedrock

Because of the relatively gentle ground topography beneath the dumps, bedding planes are unlikely to be potential slip surfaces below the waste dump. In addition, the bedrock is generally more competent than the surficial soil deposits, and in any case will not have lower friction angles than the value assumed for the colluvium (see Section 6.1.1).

As massive failures that would compromise the overall stability of the dump are not considered to be a realistic possibility, failure mechanisms through bedrock were not considered in the stability analysis.

6.1.3 Groundwater

Observations of seepage in test pits and minor creeks crossing the dump sites indicate that the water table is close to the ground surface. As a result, the groundwater table was assumed to be at the ground surface in the stability analysis.

6.2 STABILITY ANALYSES AND DUMP PLACEMENT CONCEPTS

6.2.1 Placement of Waste Rock Over Coarse Grained Soil and Bedrock

Where waste rock is placed directly onto coarse grained soils (defined as soil containing no more than 10% silt and clay fines), or onto bedrock, no limitation need be imposed on the height of the dump. Factors of safety for potential sliding surfaces through the foundation will be high, generally exceeding 1.5. However, routine performance monitoring should be conducted to provide a warning of any impending instability within the dump material. Such instability is expected to generally be restricted to shallow depths along failure surfaces which are close behind the repose angle slopes of the dumped rockfill.

Application

Portions of the fluvioglacial deposits within each of the dump sites consist of coarse grained soil. However, because of lateral variations in gradational characteristics which are common to fluvial deposits, in the absence of very detailed test pit information, it would be prudent to assume that layers of fine material may be present and, hence, the placement procedures described in Section 6.2.2 for mixed grained soils should generally be followed.

If there is a distinct advantage to dumping in one single thick lift, this may be feasible over much of the North and Alternate Dump sites. However, much more intensive test pitting would have to be done to delineate portions of the fluvioglacial cover which would be sufficiently coarse to support a single lift.

The only location where an initial dumping lift more than 22m thick (see Section 6.2.2) is acceptable on the basis of available test pit information is where colluvium rests directly on bedrock in the upper part of the South Dump, above an elevation of approximately 850m (see Section 3.6.2 and Fig. 15).

6.2.2 Placement of Waste Rock Over Mixed Grained Soils

Mixed grained soils consist of a mixture of fine and coarse sizes, including silt and clay particles. Both glacial till and some of the fluvioglacial deposits are in this category. Exposures of colluvium are limited to the southern part of the South Dump site. However, till is relatively widespread over much of the dump sites. Although test pitting indicates that the fluvioglacial material is predominantly sand or sand and gravel without an appreciable fines content, softer silty layers are definitely possible and the dump should be designed with this in mind.

Both the till and some fluvioglacial deposits are relatively soft within a few metres of the ground surface, particularly where the water table is high, as within swampy depressions. Although both materials are expected to drain fairly rapidly upon being loaded, in the short term, undrained shear strengths are probably applicable. A lower bound strength of 100 kPa is considered appropriate for the first dump lift on the basis of pocket penetrometer and torvane strength determinations of samples obtained from the test pits. For free dumped waste rock at a repose angle of 37° , the maximum safe height of dumping is 22m, with a minimum safety factor against a base failure of 1.3 (see Fig. 27). The thickness

of the second lift can be increased to approximately 29m, while maintaining the same safety factor. It is assumed that by the time the second lift is constructed, consolidation will have resulted in the till increasing in strength to 150 kPa.

A setback of a minimum distance of 40m should be left between the toe of Lift 2 and the crest of Lift 1 (see Fig. 28). This corresponds to an overall slope angle of 26° (2 horizontal to 1 vertical), which should be the maximum angle adopted for the slopes around the perimeter of the dump. If the bottom lift of waste rock is given sufficient time to allow the underlying soil to consolidate, the setback of the upper lift could possibly be reduced somewhat, if necessary. However, the time for complete consolidation to occur in the till and fluvio-glacial deposits is estimated to be in the order of 650 days, where the deposits are 5m deep.

Application

The entire North and Alternate Dumps can be constructed in two lifts, having a total thickness of 51m, with the exception of a small part of the west side of the North Dump, which is planned to a thickness of 65m. Three lifts are recommended in this area, unless further subsurface investigations demonstrate that the surficial sediments are coarse grained. The design also applies to the middle part of the South Dump, where colluvium rests on medium to coarse grained fluvio-glacial deposits (see Fig. 15). This deposit lies between elevations of approximately 820m and 850m (see Section 3.6.2 and Section A-A through the South Dump (Fig. 16).

In the case of the single extended North Dump, the crest of the completed dump would be constructed to an elevation of 1015m, rather than 920m as presently planned. The initial two lifts should be constructed as proposed above. The remainder of the dump should also be constructed in a minimum of two additional lifts with the first additional lift not exceeding 40m in thickness and the final lift not exceeding 55m in thickness. Setbacks between the toe of the upper lift and the crest of the underlying lift should be such as to maintain an average slope of 26° .

In the case of the Centre Dump, the initial lift should not exceed a thickness of 22m. It is understood that the total dump thickness is about 30m, hence, this dump could be constructed in two lifts, provided additional investigations confirm anticipated foundation conditions at this site.

6.2.3 Placement of Waste Rock Over Fine Grained Soil

Fine grained soils are defined as stratified material, containing a high percentage of silt and clay sizes, with the potential for a relatively soft layer being present. This soil was deposited under lacustrine conditions. A pocket of lacustrine silt and clay exists within the fluvio-glacial sand and gravel deposit in the lower part of the South Dump site. The approximate extent of this deposit is shown on Fig. 15.

Based on samples obtained from test pits, the lower bound undrained shear strength of the lacustrine material is estimated to be 50 kPa. In general, the strength of this deposit appears to drop with increasing depth. Lacustrine clay com-

monly exhibits a trend of decreasing strength with depth because of surface weathering effects which tend to increase the strength of the near surface soil. The soil reaches a minimum strength at a particular depth, below which point the strength will increase. Because the sampling depth reached by test pitting was limited, it is possible that the minimum strength of the lacustrine deposit is actually less than 50 kPa, in which case the berm design would be non-conservative. However, a lower bound strength of 50 kPa is considered to be realistic for preliminary design on the basis of the current data.

When crossing the lacustrine deposit, the initial lift should not exceed a thickness of 10m, to maintain a minimum safety factor of 1.3. The second lift should be no thicker than 17m (Fig. 27). The third lift is not expected to present a problem, but should be no thicker than approximately 30m. As the maximum thickness of the South Dump is expected to not exceed approximately 50m, this portion of the dump can be built in three lifts.

A setback of a minimum distance of 80m should be left between the toe of the upper lift and the crest of the underlying lift (Fig. 28). This corresponds to an overall slope angle of 13.5° (4.2 horizontal to 1 vertical), which should be the maximum angle adopted when multiple lifts are being advanced across the fine grained deposit. Because the deposit is relatively thick, the time required for a significant degree of consolidation to occur would likely be excessive in relation to the rate of dump construction. Therefore, steeper construction slopes than those indicated for multiple lift dumping are probably not possible.

The lacustrine deposit extends from approximately elevation 820 - 830m near the middle of the dump site, to approximately 790m near the lower end of the dump. The extent of the assumed lacustrine silt deposit along Section A-A, drawn from the top to bottom of the dump, is shown on Fig. 16. The lift height restrictions described above should be applied to this part of the dump.

6.3 RECOMMENDATIONS

Recommendations for foundation preparation, dump design and monitoring are summarized as follows. Detailed dump placement concepts are described above in Section 6.2. It is recommended that the final design and construction sequencing be reviewed prior to commencement of dumping.

6.3.1 Foundation Preparation

- a) Excessively soft (less than approximately 100 kPa undrained strength) material contained within wetland deposits should be excavated down to the level of competent glacial till or colluvium.
- b) Peat deposits should be removed where present in thicknesses greater than 150mm.

6.3.2 North and Alternate Dump Designs

The following lift height restrictions are based on the assumption that there will be insufficient time available for the foundation soils to fully consolidate under the applied loads. Allowable lift thicknesses may be increased if it can

be demonstrated that a sufficient reduction of pore pressures and a corresponding strength gain have occurred due to consolidation.

- a) Where the height of dump does not exceed 51m, both dumps can be constructed in two lifts, with the first lift not exceeding a thickness of 22m. Where the total dump height exceeds 51m, as in the western part of the North Dump, a third lift should be used.

In the case of the extended North Dump, a minimum of two additional lifts should be constructed. The first additional lift should not exceed a thickness of 40m and the final lift should be limited to no more than 55m.

- b) A minimum setback of 40m should be maintained between the crest of the bottom lift and the toe of the upper lift, corresponding to an overall slope angle no steeper than 26° . The third and fourth lifts of the extended North Dump should also be setback a sufficient distance so as to maintain an overall slope of 26° . The setback required for the third lift would thus be 30m, and for the fourth lift, 40m.

6.3.3 Centre Dump Design

The Centre Dump should be constructed in two lifts, with the initial lift not exceeding 22m, to the maximum anticipated height of about 30m. Sufficient setback should be incorporated between lifts such that an average overall slope of 26° is not exceeded. Foundation conditions for this site should be checked prior to placement of any waste material.

6.3.4 South Dump Design

a) Colluvium

Where waste rock is placed directly on colluvium, or bedrock (above an approximate elevation of 850m), no restriction need be observed on the height of dumping.

b) Fluvioglacial Deposits

Where waste rock is placed on fluvioglacial deposits present between approximate elevations of 820m and 850m, and below elevations of 790m to 835m, the initial dump lift should not exceed a thickness of 22m. The second lift should be no thicker than 29m. A minimum setback of 40m should be maintained between the crest of the bottom lift and the toe of the upper lift, corresponding to an overall slope angle no steeper than 26° .

c) Lacustrine Silt

Where waste rock is placed onto the lacustrine silt deposit between approximate elevations of 790m and 820m, the initial lift should not exceed a thickness of 10m. The second lift should be no thicker than 17m and the third lift no thicker than 30m. A minimum setback of 80m should be maintained between the crest of the underlying lift and toe of the overlying lift, corresponding to an overall slope angle no steeper than 13.5° .

6.3.5 Separation From Pit and Conveyor

A separation between the toe of all dumps and the crest of the pit should be maintained at not less than 30m. Similarly, a minimum separation of 30m should also be observed between the conveyor line and the reclaimed toe of the North and Alternate Dumps.

6.3.6 Monitoring

The performance of each dump should be monitored during construction to ensure that the dump foundations do not become overstressed and initiate a failure. Monitoring of the initial phases of dump construction should provide valuable information on how the foundations perform under load. In this respect, measurements of deformation and pore pressures should be obtained in the lacustrine silt deposit. Such measurements will serve both to confirm the dump behaviour and to warn of any impending failure through the foundation material. In addition, if it is desired to increase the thickness of dump lifts from the values recommended herein, pore pressure measurements should also be measured in the mixed grain soils.

6.3.7 Additional Investigations

- a) Additional subsurface investigations are recommended to better delineate the extent of the lacustrine deposit in the South Dump site and to determine the strength profile from top to bottom of the deposit. Two or three holes should be drilled with closely spaced sampling and vane testing to determine the vertical in situ strength pro-

file. Additional holes should also be drilled with intermittent sampling to define the boundaries of the silt deposit.

- b) In conjunction with the drilling program for the silt deposit, two or three holes should also be drilled in the till deposit within the North Dump site. The holes should be located within topographic depressions, where the till may be softened, to permit confirmation of the strength profile and consolidation parameters assumed in the stability analysis.
- c) Foundation conditions in the vicinity of the Centre Dump site should be confirmed. In this regard, it is recommended that limited test pitting combined with field reconnaissance be conducted in this area before dump construction commences.
- d) Laboratory strength determinations should be made on samples of lacustrine silt from the South Dump site. The stability and design of this dump should then be re-analyzed on the basis of the finalized strength profile and assessment of extent of the silt deposit.



7. ACKNOWLEDGEMENTS

The authors acknowledge with thanks the assistance and cooperation of Quintette Coal Limited personnel during the course of the work. The authors particularly express their thanks to Messrs. J. Hendry, B. Wong and D. McNeil for their help during the studies.

Respectfully submitted,
PITEAU ASSOCIATES ENGINEERING LTD.

Alan F. Stewart, P.Eng.

F.B. Claridge, P.Eng.

P.M. Hawley, P.Eng.

A.T. Holmes, P.Eng.

May 7, 1985

8. REFERENCES

- Anon., 1981. Description of Geology of Quintette Property. Internal QCL Geological Report.
- Golder Associates, 1982a. "Report to Denison Mines Ltd. on Preliminary Geotechnical Studies for the Syncline Extension Mine". May.
- Golder Associates, 1982b. "Report to Denison Mines Ltd. on Hydrogeology of the Quintette Project, British Columbia". May.
- Golder Associates, 1985. "Preliminary Test Pit Logs for Shikano Sedimentation Ponds". April.
- Hardy Associates (1978) Ltd., 1982. "Design Memo No. 1 - Coal Conveyor - Quintette Mine". October.
- Hoek, E. and Brown, E.T., 1980. "Underground Excavations in Rock". Institution of Mining and Metallurgy, London.
- Hvorslev, M.J., 1951. "Time Lag and Soil Permeability in Groundwater Observations". U.S. Army Corps of Engineers, Waterways Experimental Station, Vicksburg, Miss. Bull. 36.
- Piteau, D.R. and Russell, L., 1971. "Cumulative Sums Technique: A New Approach to Analyzing Joints in Rock". Stability of Rock Slopes, ASCE 13th Symposium on Rock Slopes, Urbana, Illinois.

FIGURES

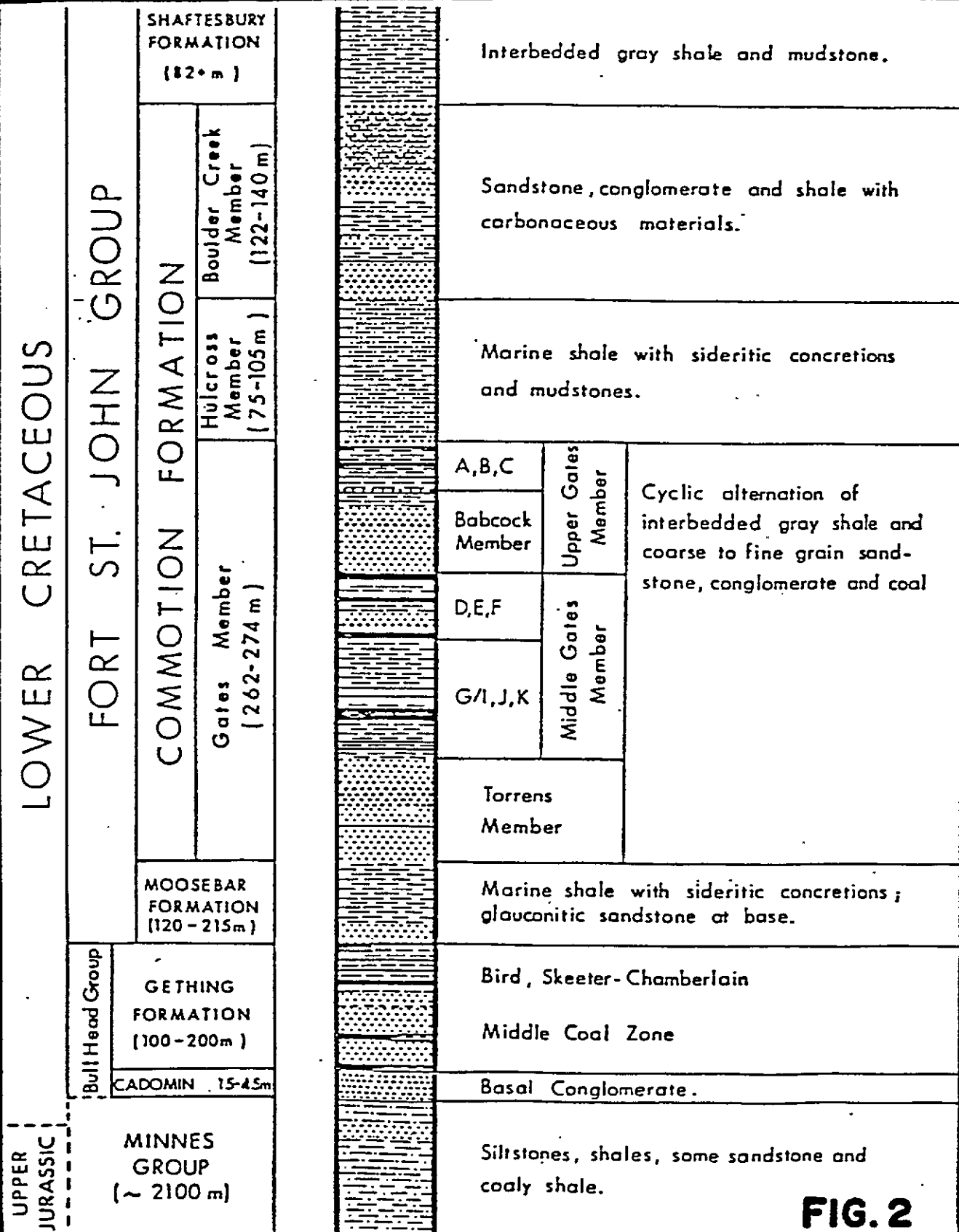

FIG. 2

QUINETTE COAL LIMITED
DENISON MINES LIMITED
SHIKANO DEVELOPMENT



PITEAU & ASSOCIATES
GEOTECHNICAL CONSULTANTS
VANCOUVER CALGARY

GENERAL STRATIGRAPHIC COLUMN (After QUINETTE COAL LTD.; 1981)

BY:	DATE:
PMH	APR 85
APPROVED:	DWG:
<i>Q.F.</i>	339-X4-2

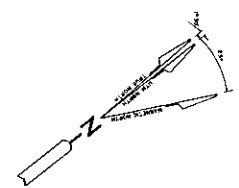

- GEOLOGIC FORMATIONS**
- KS SHAFTESBURY
 - KCB BOULDER CREEK
 - KCH HULCROSS
 - KCG GATES
 - KM MOOSEBAR

- SURVEYED ROAD
- UNSURVEYED ROAD
- COAL SEAM OUTCROP
- COAL SEAM SUBCROP
- GEOLOGIC CONTACT

- SYNCLINE
- ANTICLINE
- THRUST FAULT
- DIP & STRIKE
- ADIT
- DRILL HOLE
- PIEZOMETER HOLE
- GEOTECHNICALLY LOGGED HOLE

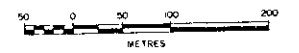

3	230585	REVISED GEOLOGY & ORIENTATION	E J T		
2	170485	UPDATED DRILL HOLE LOCATIONS	K L R	D M L	D M L
1	290385	UPDATED D.H. LOCATIONS	K J V	D M L	D M L
0	120285	ORIGINAL DRAFT	K J V	D J	D J
Rev	D M Y	Revision Description	Rev.	Des.	App.

QUINTETTE COAL LIMITED
 Project Manager
DENISON MINES LIMITED
 COAL DIVISION

PITEAU & ASSOCIATES
 GEOTECHNICAL CONSULTANTS
 VANCOUVER CALGARY

SHIKANO DEVELOPMENT
GEOLOGICAL AND DRILLHOLE LOCATION PLAN
 FIG. 3

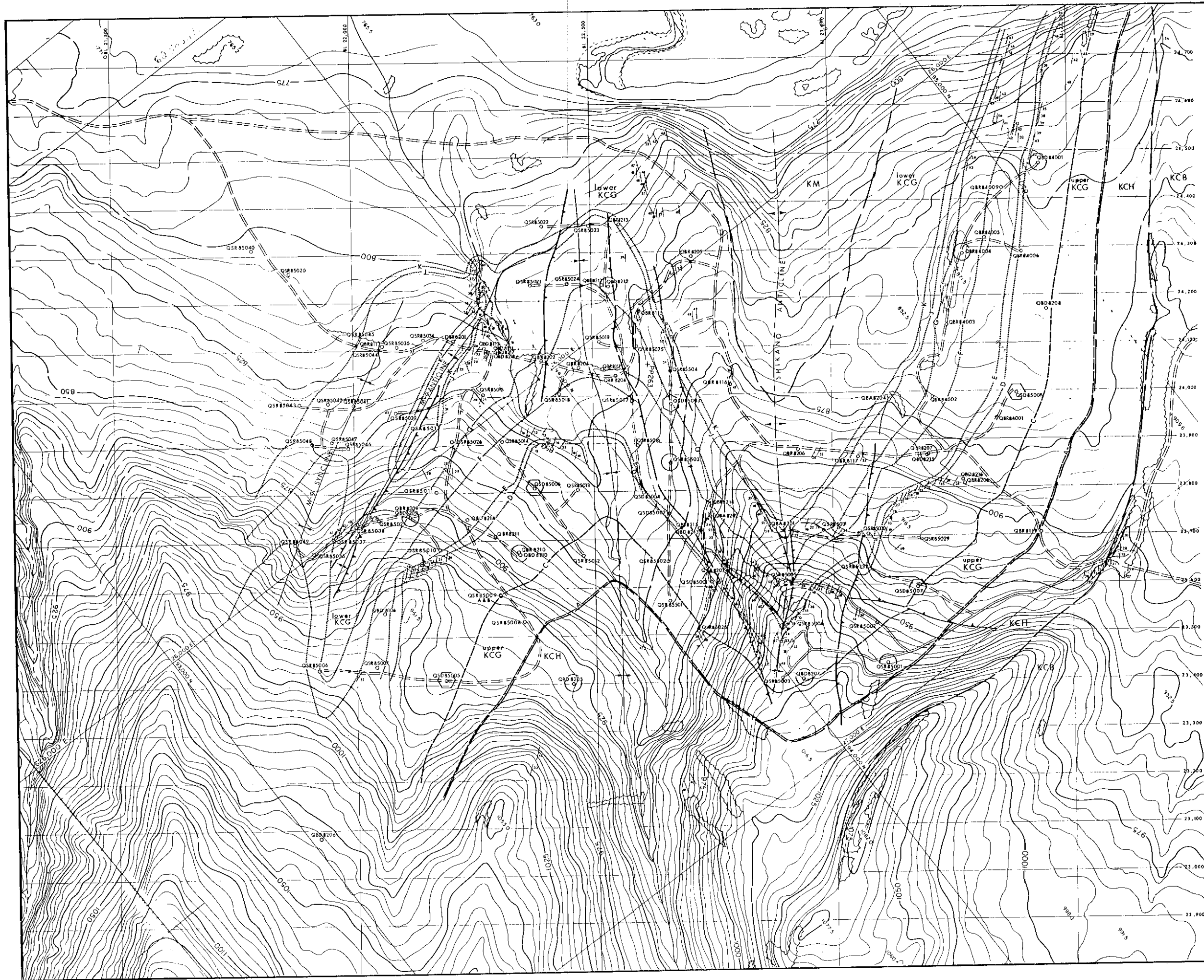

OBSERVATIONS: 36
 POPULATION: 36

CONTOUR PLOT

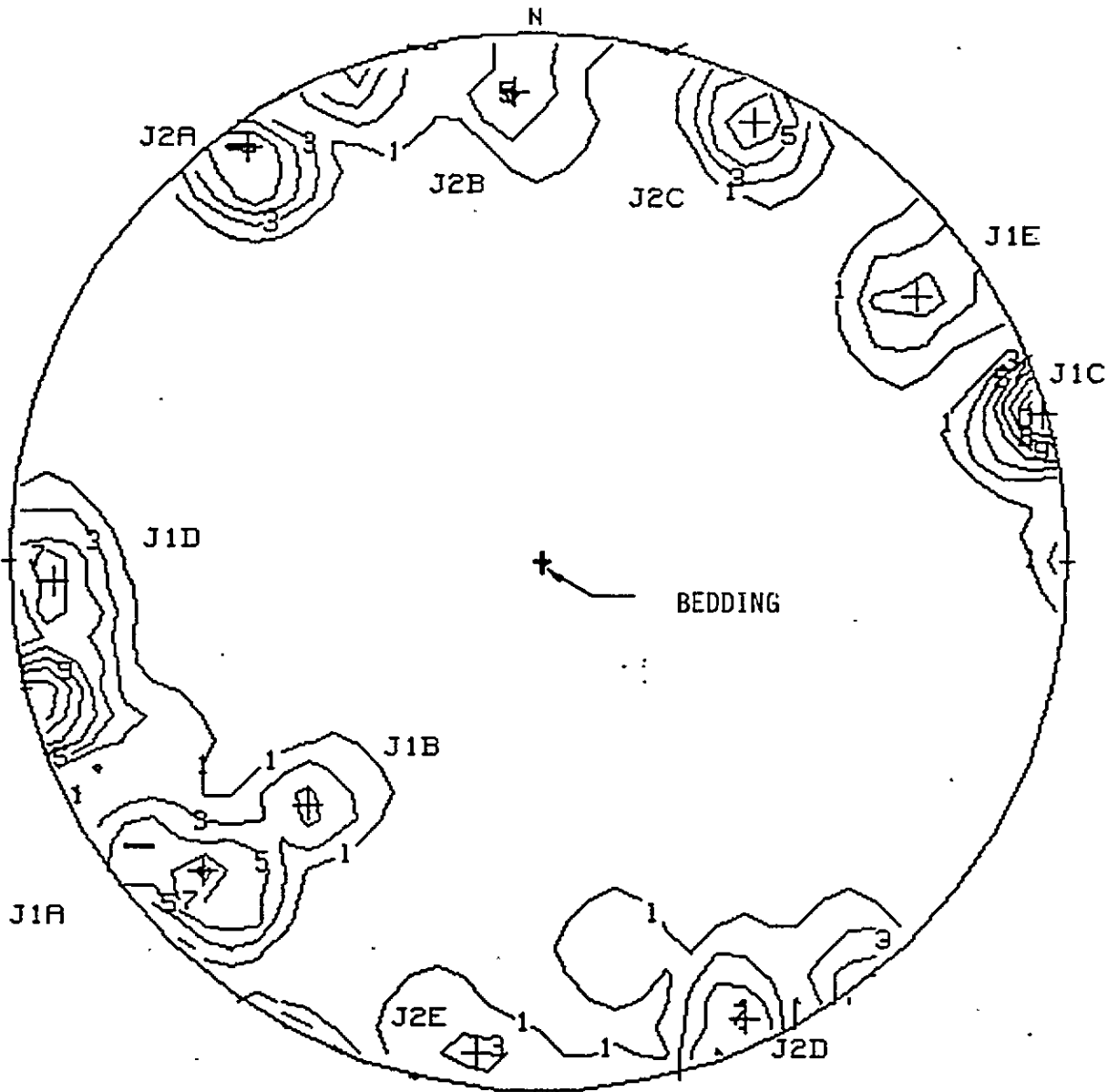

<u>LABEL</u>	<u>DIP DIRECTION</u>	<u>DIP</u>	<u>CONCENTRATION (%)</u>
J1A	047	75	10
J1B	044	54	6
J1C	254	89	15
J1D	088	81	8
J1E	235	76	6
J2A	145	85	9
J2B	177	78	6
J2C	206	82	8
J2D	336	84	7
J2E	007	83	4

FIG.5

QUINETTE COAL LIMITED
 DENISON MINES LIMITED
 SHIKANO DEVELOPMENT



PITEAU & ASSOCIATES
 GEOTECHNICAL CONSULTANTS
 VANCOUVER CALGARY

GEODAT: LOWER HEMISPHERE EQUAL AREA PROJECTION
 ALL ROTATED JOINTS RELATIVE TO BEDDING ORIENTATION OF 000/00

By: P11H Date: APR 85

C.S. 339-X4-5

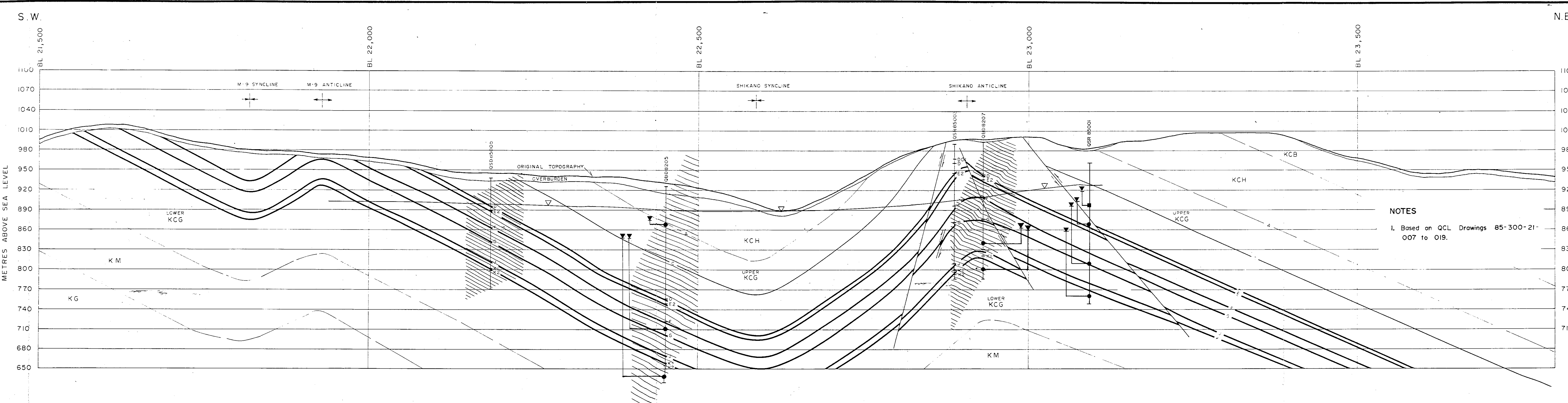

NOTES
 1. Based on QCL Drawings 85-300-21-007 to 019.

LEGEND

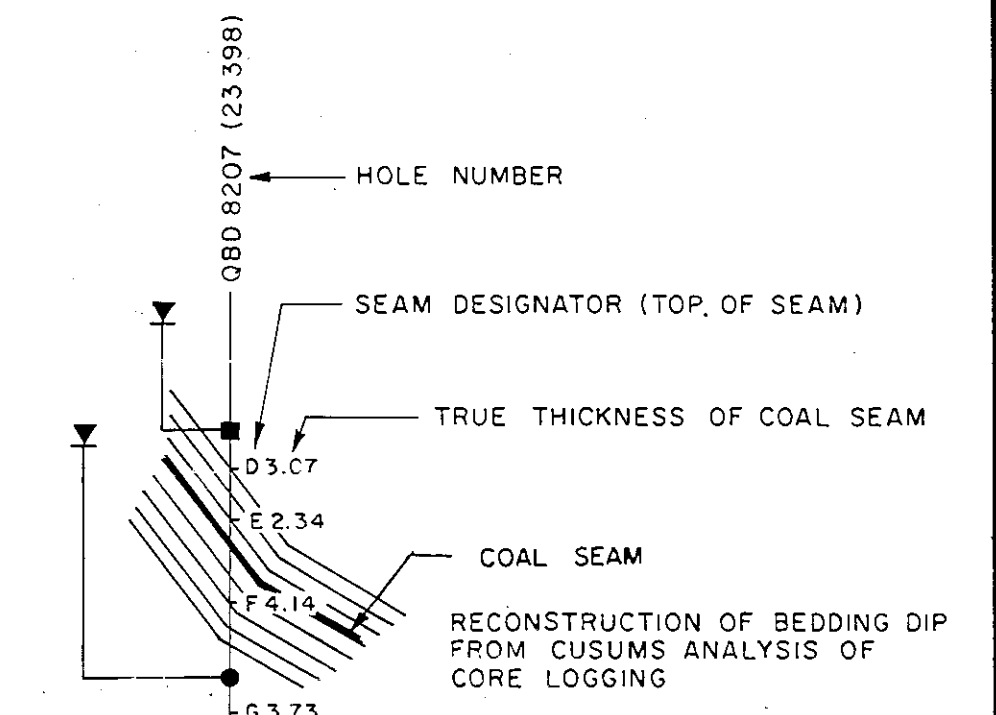

SECTION VIEW OF DIAMOND OR ROTARY DRILLHOLE SHOWING PIEZOMETER (●) AND STANDPIPE (■) LOCATIONS AND PIEZOMETRIC LEVELS

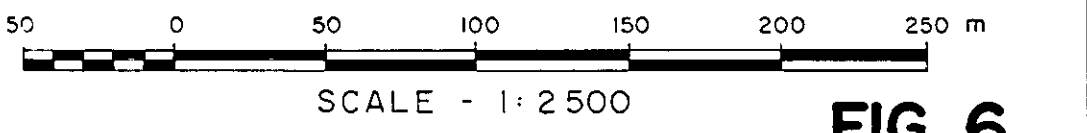
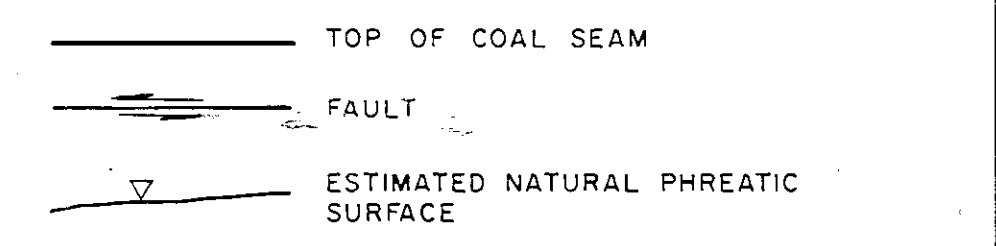
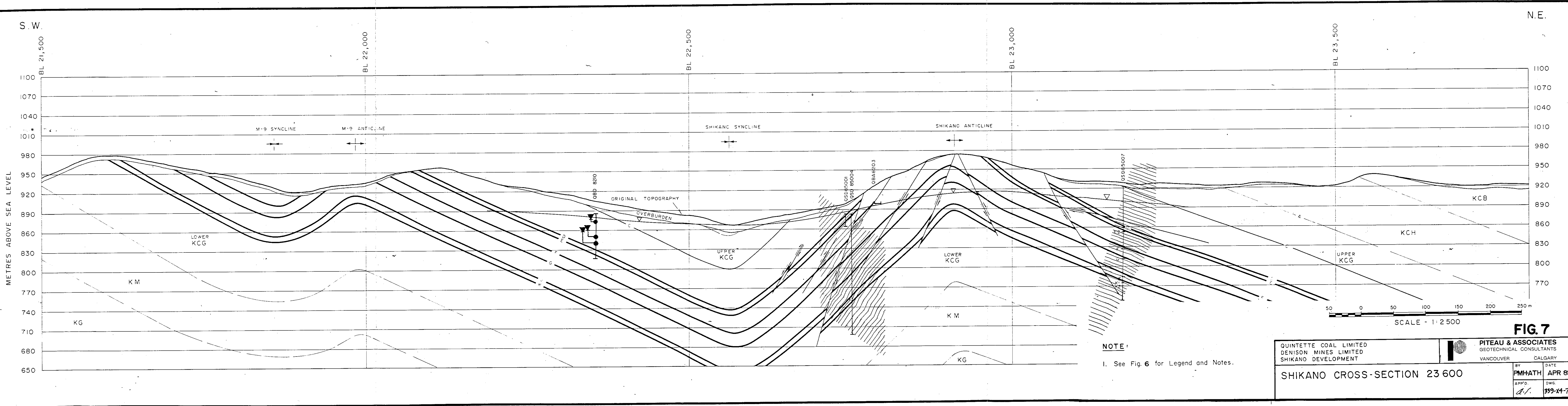

FIG. 6

QUINTETTE COAL LIMITED DENISON MINES LIMITED SHIKANO DEVELOPMENT		PITEAU & ASSOCIATES GEOTECHNICAL CONSULTANTS VANCOUVER CALGARY	
SHIKANO CROSS-SECTION 23 400		BY PMH:ATH	DATE APR 85
APP'D <i>[Signature]</i>	DWG 339-X4-6		



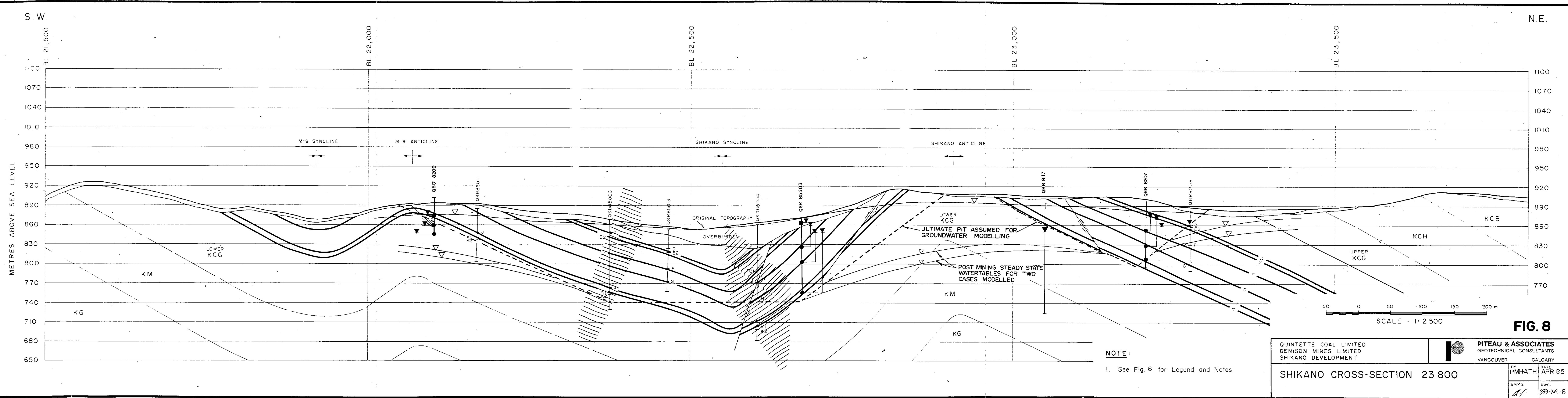
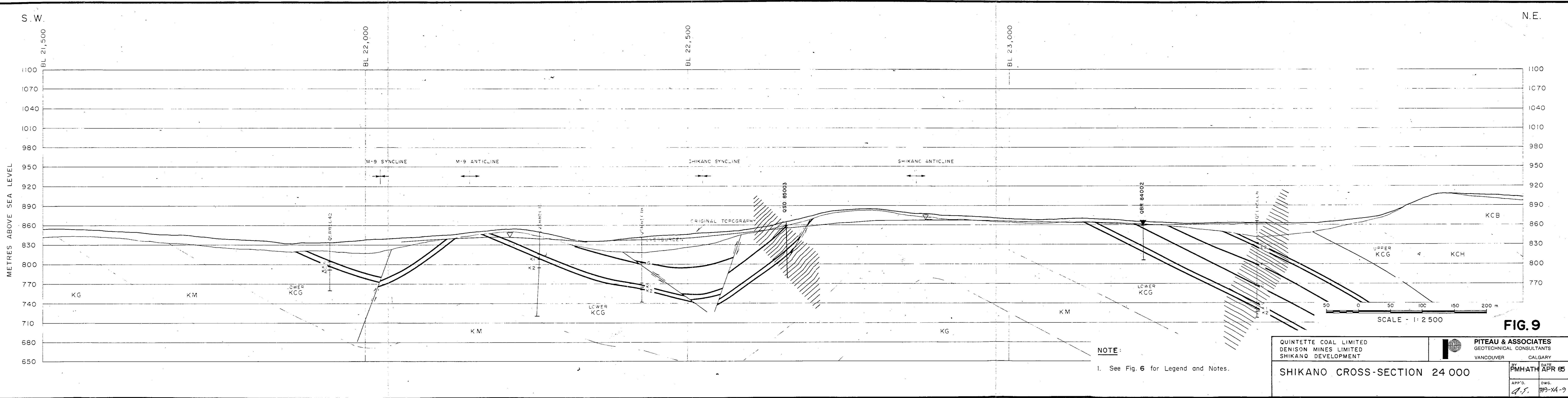

FIG. 8

QUINTETTE COAL LIMITED DENISON MINES LIMITED SHIKANO DEVELOPMENT		PITEAU & ASSOCIATES GEOTECHNICAL CONSULTANTS VANCOUVER CALGARY	
SHIKANO CROSS-SECTION 23 800		BY PMHATH APP'D. <i>AV</i>	DATE APR 85 DWG. 339-X4-B



NOTE:
1. See Fig. 6 for Legend and Notes.

QUINTETTE COAL LIMITED DENISON MINES LIMITED SHIKANO DEVELOPMENT		PITEAU & ASSOCIATES GEOTECHNICAL CONSULTANTS VANCOUVER CALGARY	
SHIKANO CROSS-SECTION 24 000			
BY PMHATH	DATE APR 85	APP'D. <i>[Signature]</i>	DWG. 999-X4-9

FIG. 9

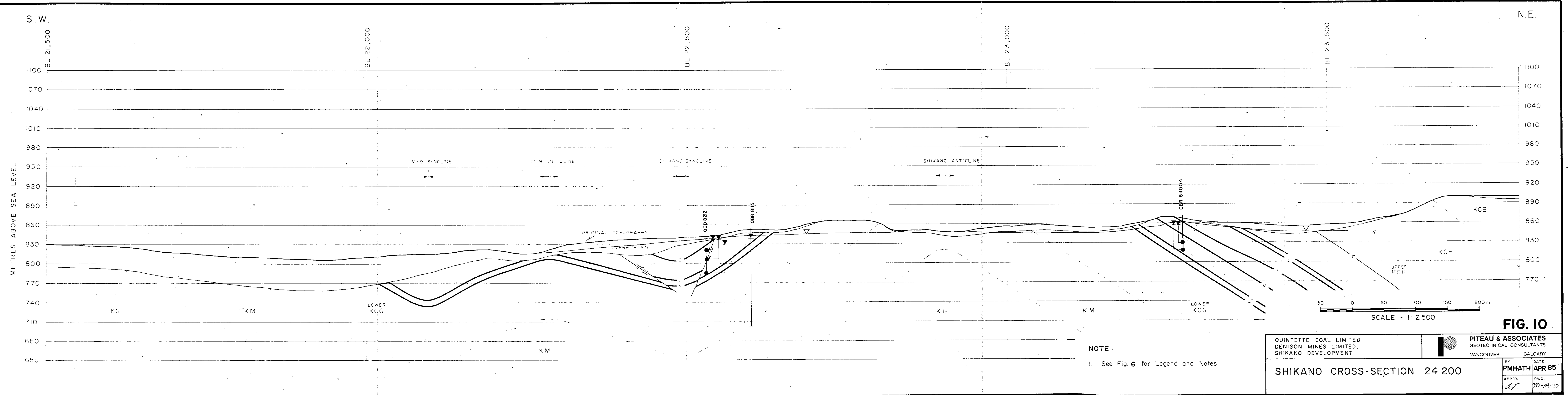

NOTE:
1. See Fig. 6 for Legend and Notes.

QUINTETTE COAL LIMITED DENISON MINES LIMITED SHIKANO DEVELOPMENT		 PITEAU & ASSOCIATES GEOTECHNICAL CONSULTANTS VANCOUVER CALGARY	
SHIKANO CROSS-SECTION 24 200		BY PMHATH	DATE APR 85
APP'D. <i>AJ.</i>	DWG. 339-X4-10		

FIG. 10

S.W.

N.E.

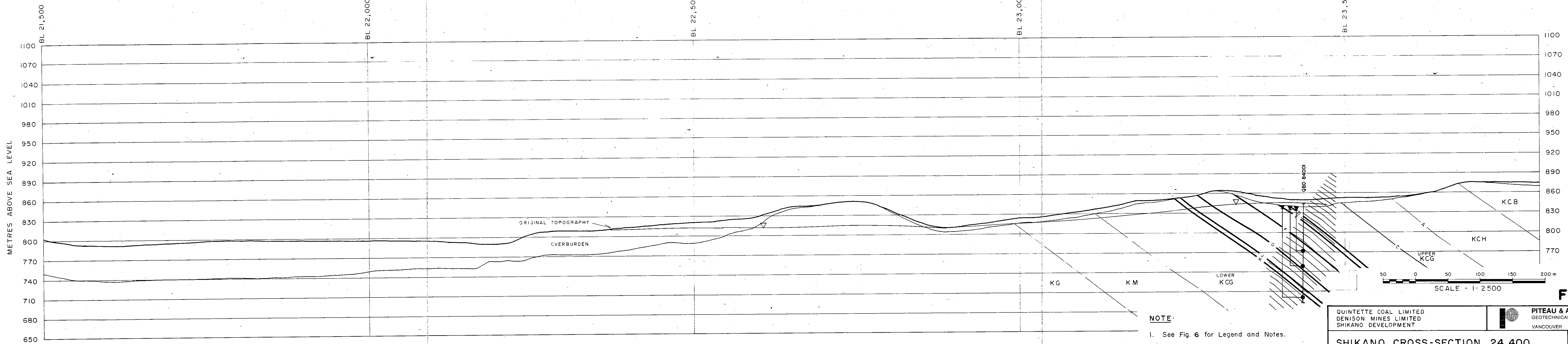

FIG. 11

QUINTETTE COAL LIMITED DENISON MINES LIMITED SHIKANO DEVELOPMENT		PITEAU & ASSOCIATES GEOTECHNICAL CONSULTANTS VANCOUVER CALGARY	
SHIKANO CROSS-SECTION 24 400		BY PMHATH	DATE APR 85
APP'D. <i>[Signature]</i>	DWG. 339-X4-11		

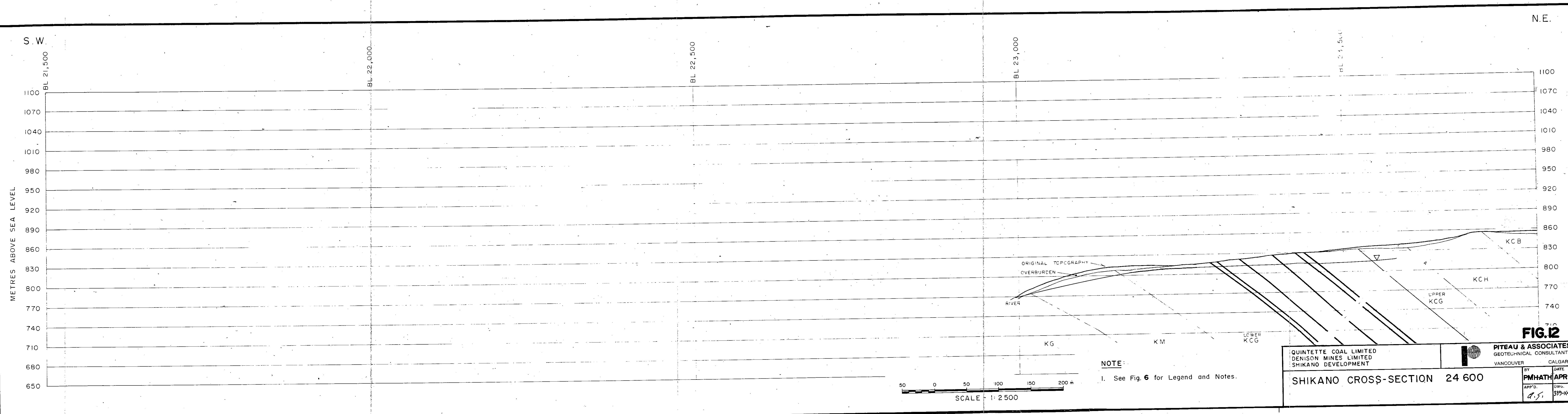
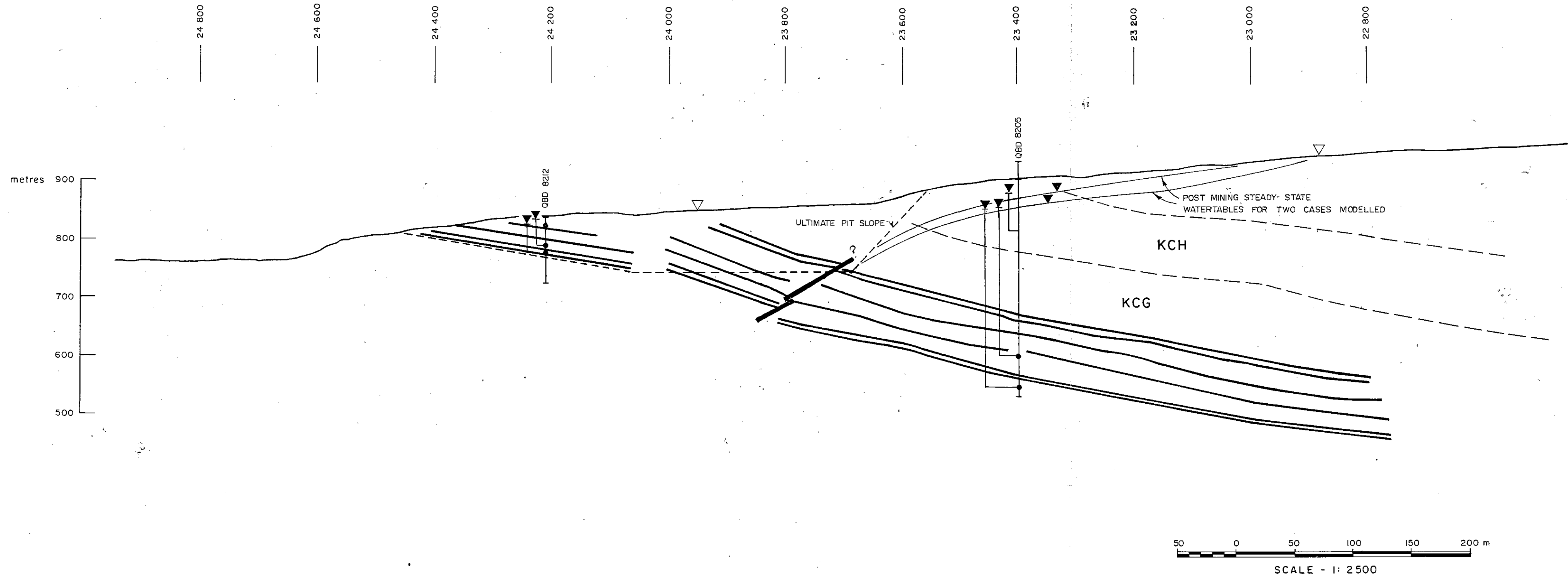

FIG.12

QUINTETTE COAL LIMITED DENISON MINES LIMITED SHIKANO DEVELOPMENT		PITEAU & ASSOCIATES GEOTECHNICAL CONSULTANTS VANCOUVER CALGARY	
SHIKANO CROSS-SECTION 24 600		BY PMHATH	DATE APR 85
APP'D. <i>[Signature]</i>	DWG. 339-X4-12		



NOTE:

1. See Fig. 6 for Legend and Notes.

FIG. 13

QUINTETTE COAL LIMITED DENISON MINES LIMITED SHIKANO DEVELOPMENT		 PITEAU & ASSOCIATES GEOTECHNICAL CONSULTANTS VANCOUVER CALGARY	
SECTION ALONG SYNCLINAL AXIS THROUGH SHIKANO PIT		BY: ATH	DATE: APR 85
		APPROVED: <i>A.T.</i>	DWG: 339-X4-13

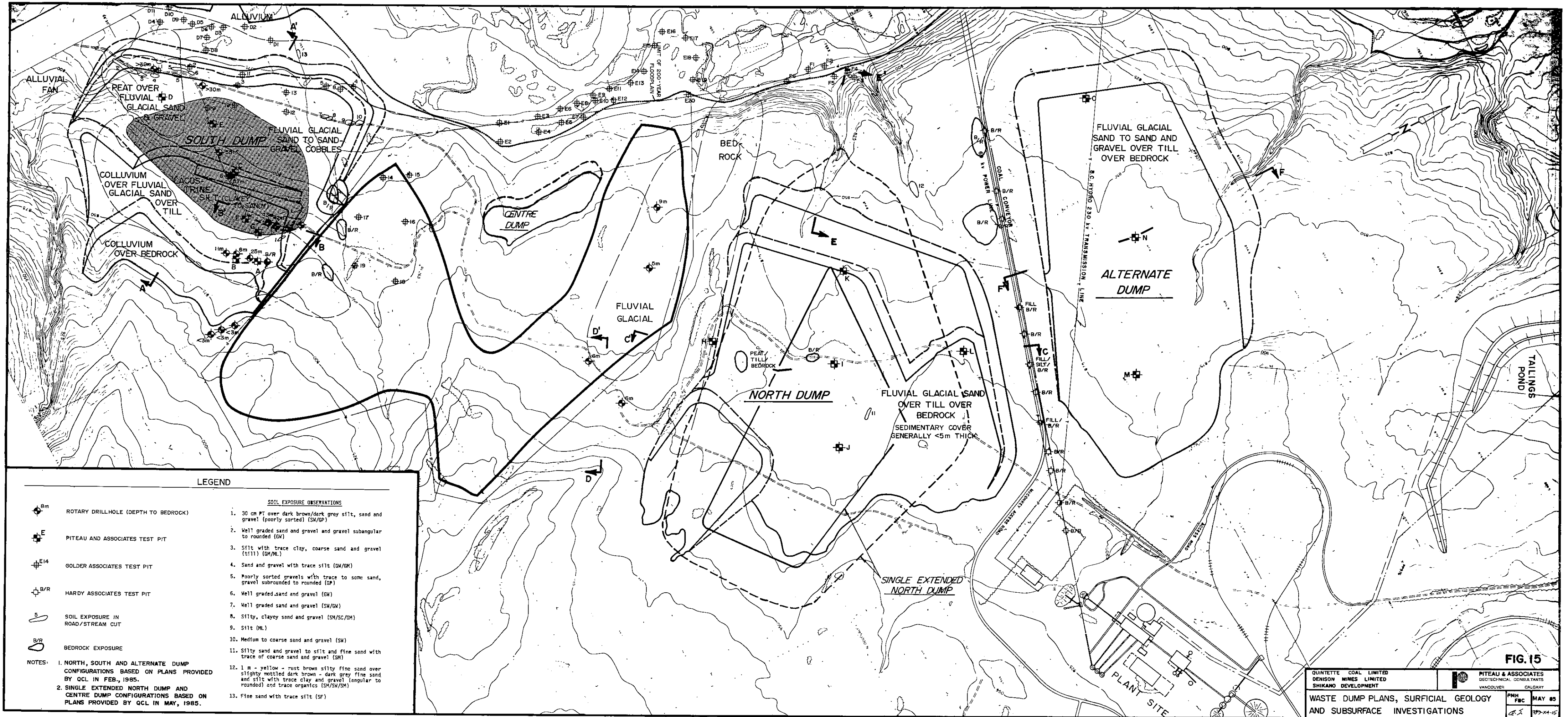

LEGEND

- ROTARY DRILLHOLE (DEPTH TO BEDROCK)
- PITEAU AND ASSOCIATES TEST PIT
- GOLDER ASSOCIATES TEST PIT
- HARDY ASSOCIATES TEST PIT
- SOIL EXPOSURE IN ROAD/STREAM CUT
- BEDROCK EXPOSURE

SOIL EXPOSURE OBSERVATIONS

1. 30 cm PT over dark brown/dark grey silt, sand and gravel (poorly sorted) (SM/GP)
2. Well graded sand and gravel and gravel subangular to rounded (GW)
3. Silt with trace clay, coarse sand and gravel (till) (GM/ML)
4. Sand and gravel with trace silt (GW/GM)
5. Poorly sorted gravels with trace to some sand, gravel subrounded to rounded (GP)
6. Well graded sand and gravel (GW)
7. Well graded sand and gravel (SM/GW)
8. Silty, clayey sand and gravel (SM/SC/GM)
9. Silt (ML)
10. Medium to coarse sand and gravel (SM)
11. Silty sand and gravel to silt and fine sand with trace of coarse sand and gravel (SM)
12. 1 m - yellow - rust brown silty fine sand over slightly mottled dark brown - dark grey fine sand and silt with trace clay and gravel (angular to rounded) and trace organics (SM/SW/SM)
13. Fine sand with trace silt (SF)

- NOTES:**
1. NORTH, SOUTH AND ALTERNATE DUMP CONFIGURATIONS BASED ON PLANS PROVIDED BY QCL IN FEB., 1985.
 2. SINGLE EXTENDED NORTH DUMP AND CENTRE DUMP CONFIGURATIONS BASED ON PLANS PROVIDED BY QCL IN MAY, 1985.

FIG. 15

QUINTETTE COAL LIMITED DENISON MINES LIMITED SHIKANO DEVELOPMENT	PITEAU & ASSOCIATES GEOTECHNICAL CONSULTANTS VANCOUVER CALGARY
WASTE DUMP PLANS, SURFICIAL GEOLOGY AND SUBSURFACE INVESTIGATIONS	
PMH FBC	MAY 85 379-24-15

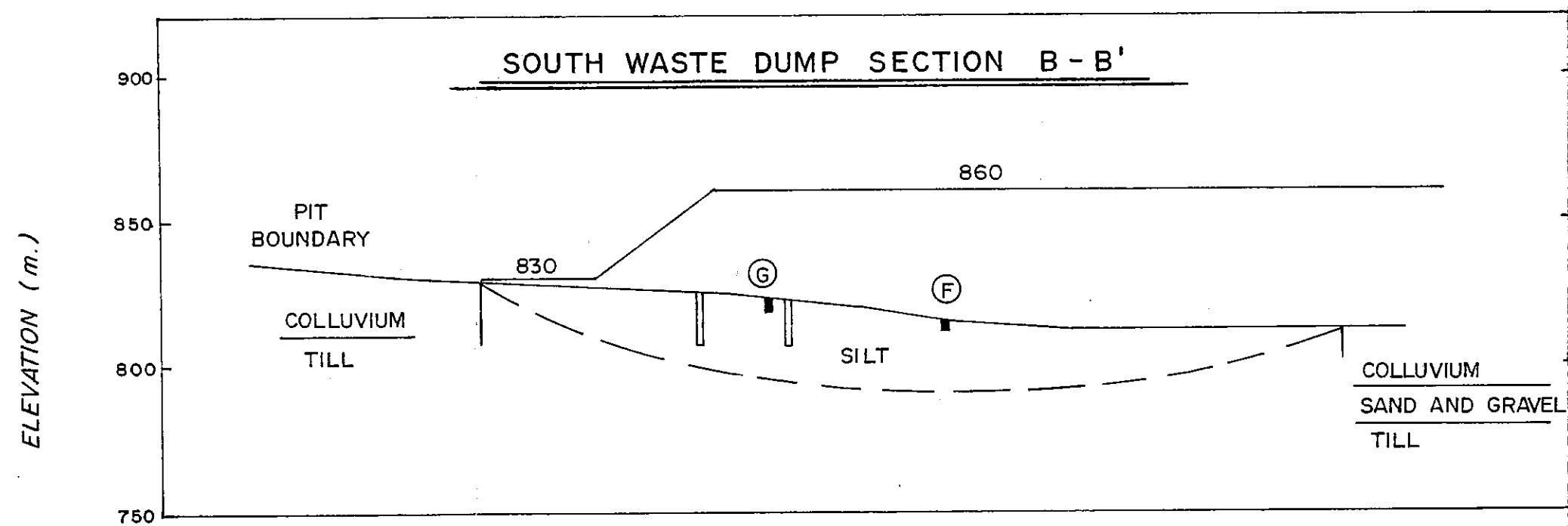
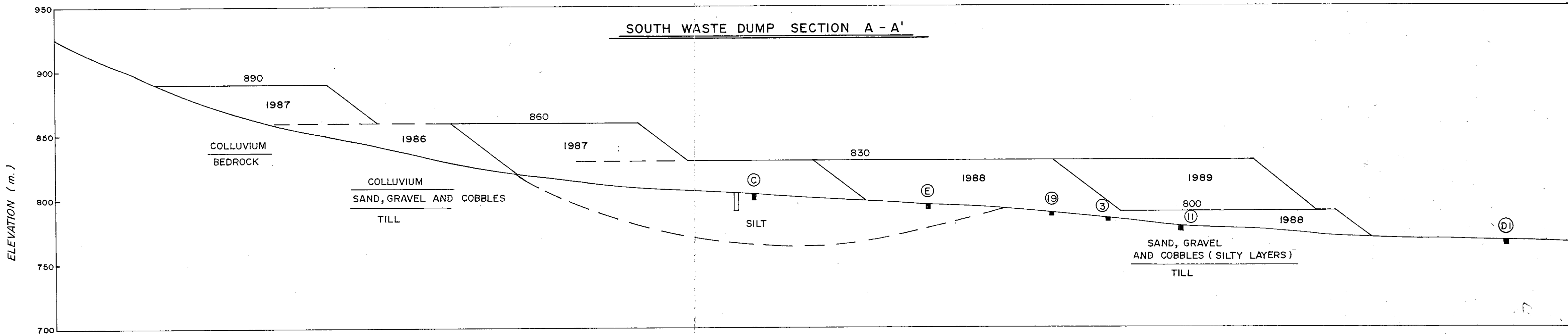

LEGEND	
ⓐ	TEST PIT
ⓑ	ROTARY HOLE

SCALE 1:2000

NOTES

- FOR LOCATIONS OF TEST PITS AND ROTARY HOLES (OFFSET FROM SECTION) SEE FIG.15
- WASTE DUMP CONFIGURATION AND SEQUENCING BASED ON PLANS PROVIDED BY QCL IN APRIL, 1985 AND MAY NOT MATCH THE DUMP CONFIGURATION IN FIG. 15

FIG. 16

QUINTETTE COAL LIMITED DENISON MINES LIMITED SHIKANO DEVELOPMENT	 PITEAU & ASSOCIATES GEOTECHNICAL CONSULTANTS VANCOUVER CALGARY	BY: FBC	DATE: APR 85
		APPROVED: <i>a.s.</i>	DWG: 339-X4-16

SOUTH WASTE DUMP SECTIONS

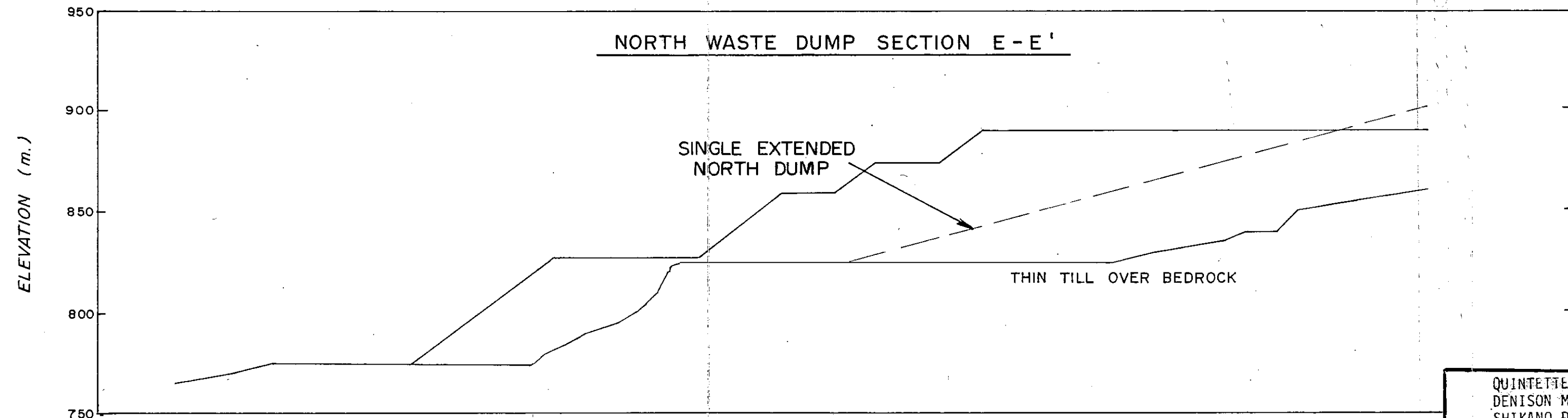
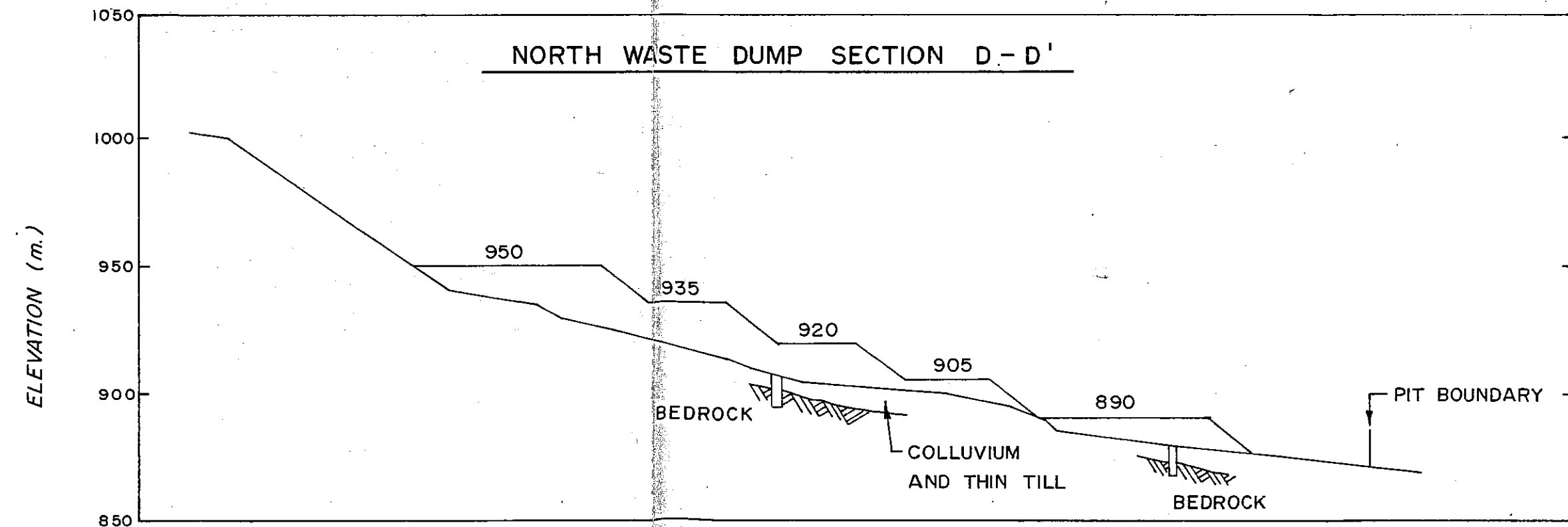
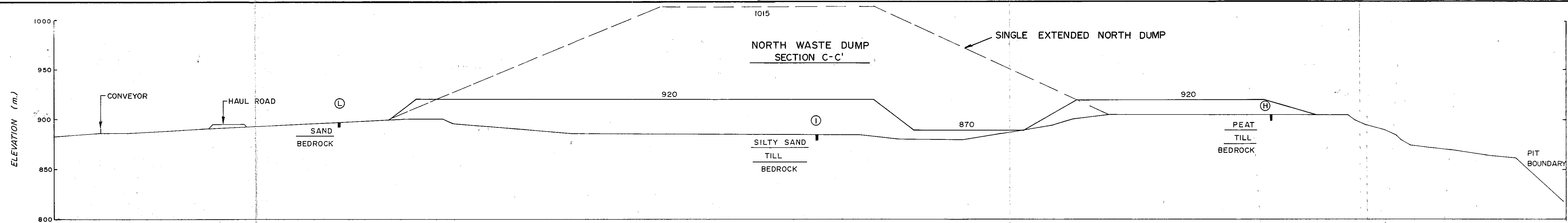

LEGEND

Ⓜ TEST PIT (FOR LOCATION SEE FIG. 15)

Ⓜ ROTARY HOLE (FOR LOCATION SEE FIG. 15)

SCALE 1:2000

NOTE: NORTH DUMP CONFIGURATION BASED ON PLANS PROVIDED BY QCL IN APR., 1985 AND MAY NOT MATCH CONFIGURATION IN FIG. 15. SINGLE EXTENDED NORTH DUMP BASED ON PLANS PROVIDED BY QCL IN MAY, 1985.

FIG. 17

QUINTETTE COAL LIMITED DENISON MINES LIMITED SHIKANO DEVELOPMENT		PITEAU & ASSOCIATES GEOTECHNICAL CONSULTANTS VANCOUVER CALGARY	
NORTH WASTE DUMP SECTIONS,		BY: FBG DATE: May '85	APPROVED: [Signature] DWG: 339-X4-17

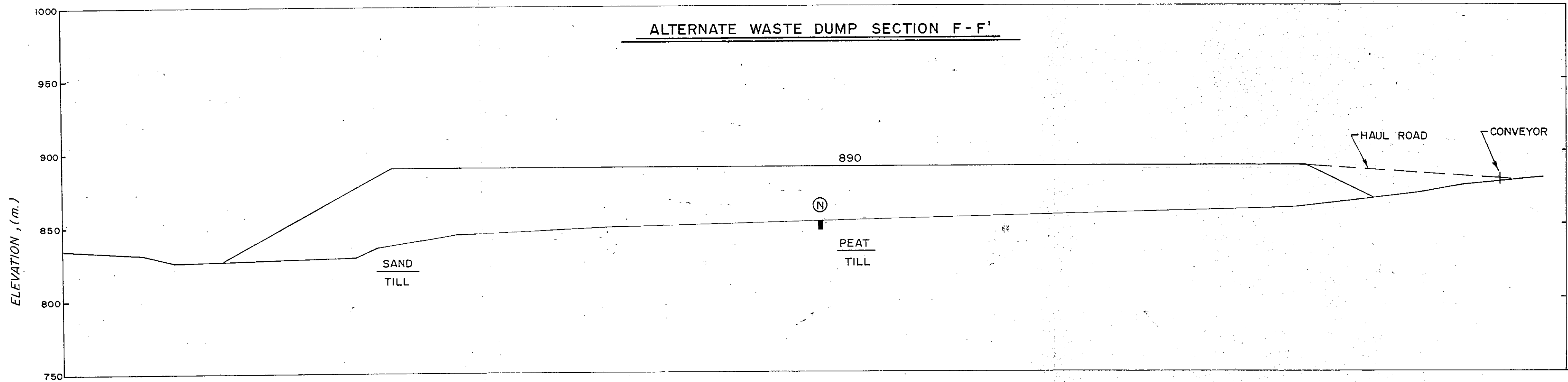

ALTERNATE WASTE DUMP SECTION F-F'

NOTE:
WASTE DUMP CONFIGURATION BASED ON PLAN
PROVIDED BY QCL IN FEBRUARY, 1985.

LEGEND	
(N)	TEST PIT (See FIG.15)

SCALE : 1: 2000

FIG. 18

QUINTETTE COAL LIMITED DENISON MINES LIMITED SHIKANO DEVELOPMENT	 PITEAU & ASSOCIATES GEOTECHNICAL CONSULTANTS VANCOUVER CALGARY	BY: FBC	DA: APR 85
		APPROVED: <i>af</i>	DWG: 339-X4-18

ALTERNATE WASTE DUMP SECTION

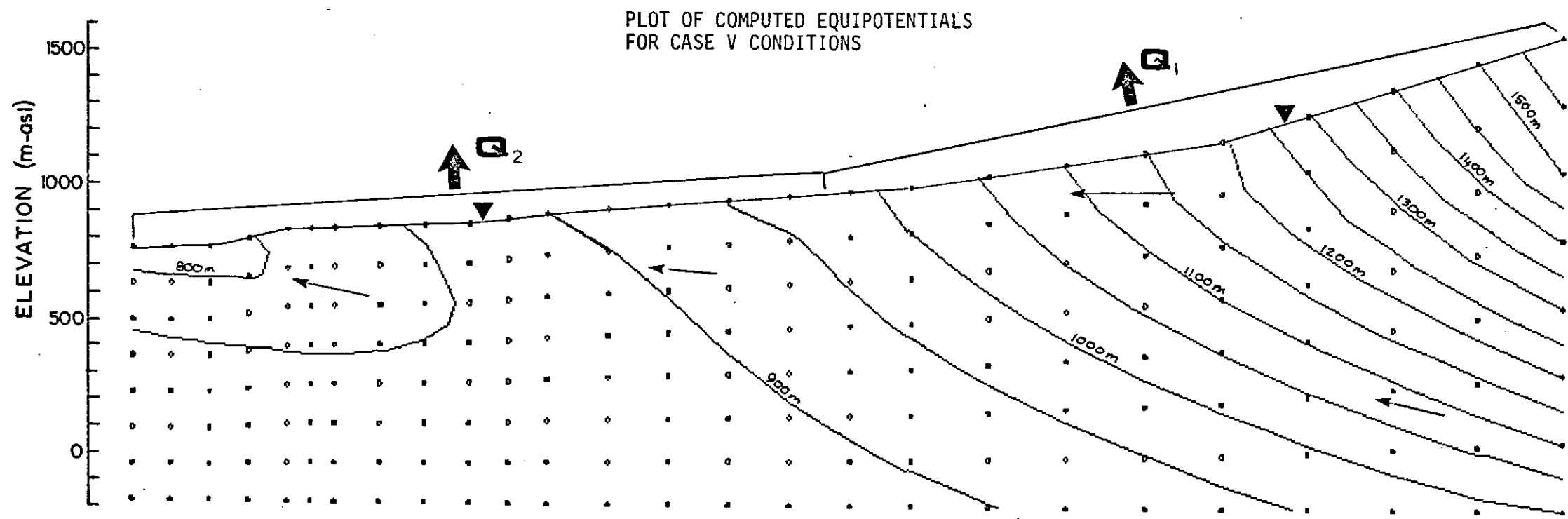
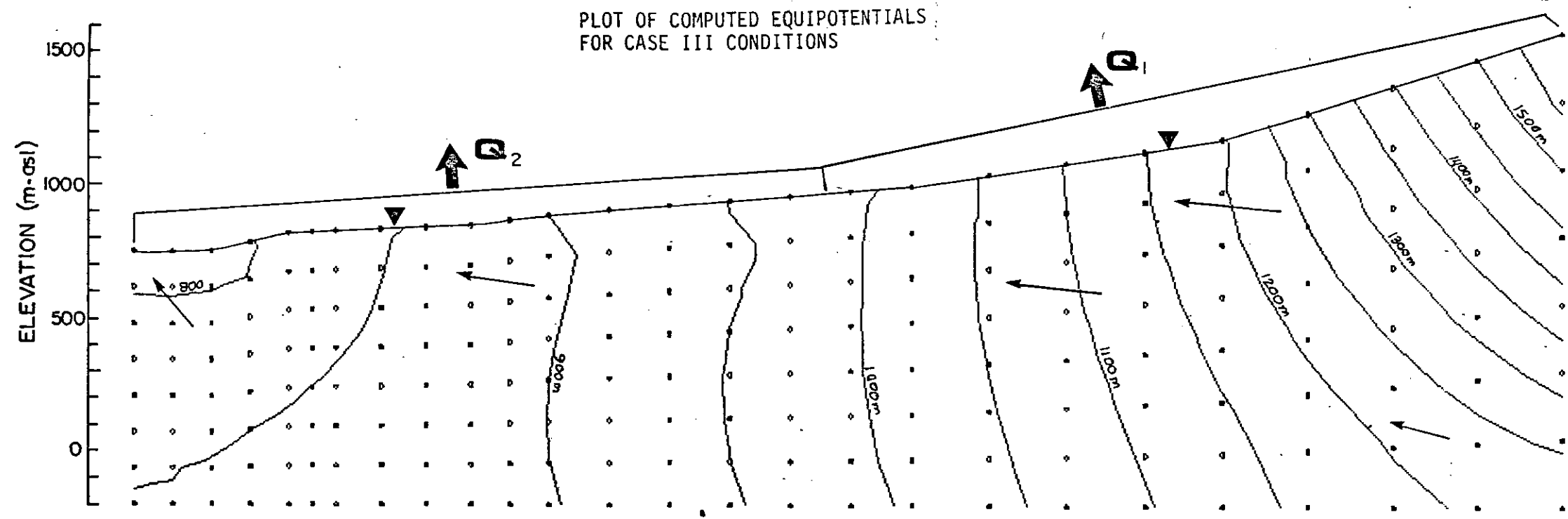

SYMBOLS

- Constant head nodes
- Flux nodes (to simulate infiltration of water from surface)
- ↔ Direction of principal (K_h) and secondary (K_v) permeabilities
- ↑ Computed discharge fluxes
- ▽ Estimated natural water table
- ▽ Computed post mining water table
- ← Groundwater flow direction
- 850m Computed equipotential

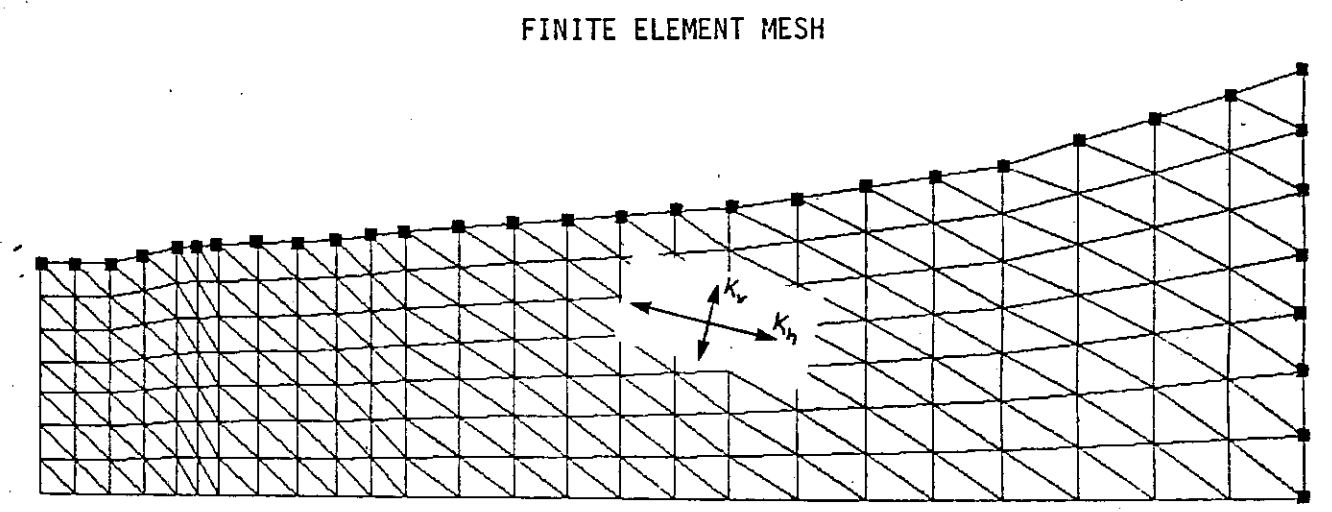

Scale 1 cm = 310m

SUMMARY OF MODELLING RESULTS

CASE	HYDRAULIC CONDUCTIVITY (m/s)		COMPUTED FLUX (L/s/m) (1)			% OF GROUNDWATER DISCHARGE ABOVE 1000m ELEV $Q_1/(Q_1+Q_2)$	ESTIMATED SPECIFIC GROUNDWATER DISCHARGE TO M11 CREEK, BASED ON 16 L/s BASEFLOW AND 800m WIDE DISCHARGE ZONE
	K_h	K_v	Q_1	Q_2	Q_3 (Total Discharge to M11)		
I	10^{-6}	10^{-7}	.14	.03	.17	82	.02
II	10^{-6}	3×10^{-8}	.10	.02	.12	83	.02
III	10^{-7}	3×10^{-8}	.015	.003	.018	83	.02
IV	10^{-7}	10^{-8}	.014	.003	.017	82	.02
V	10^{-7}	3×10^{-9}	.017	.003	.020	85	.02

NOTES: 1. Computed fluxes are for a 1m thick section, hence are in units of L/s/m of thickness.

FIG. 19

QUINTETTE COAL LIMITED DENISON MINES LIMITED SHIKANO DEVELOPMENT	PITEAU & ASSOCIATES GEOTECHNICAL CONSULTANTS VANCOUVER CALGARY	
SUMMARY OF MODELLING OF NATURAL GROUNDWATER FLOW ALONG SYNCLINAL SECTION		BY: ATH DATE: APR 85
		APPROVED: <i>A.S.</i> DWG: 339-X4-19

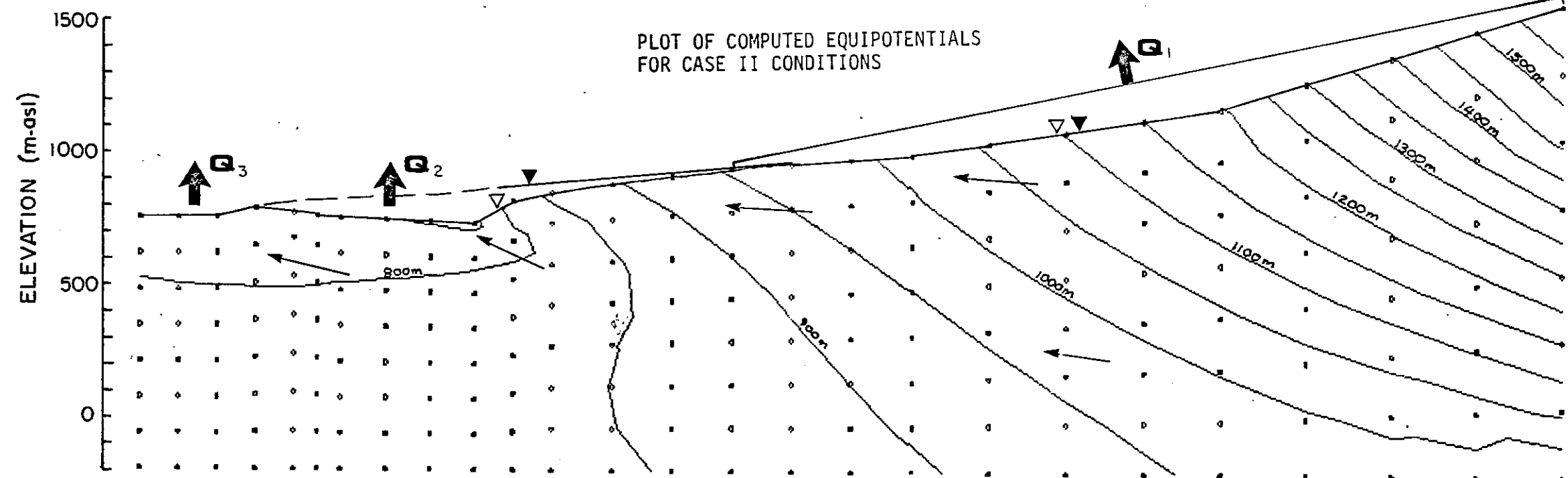
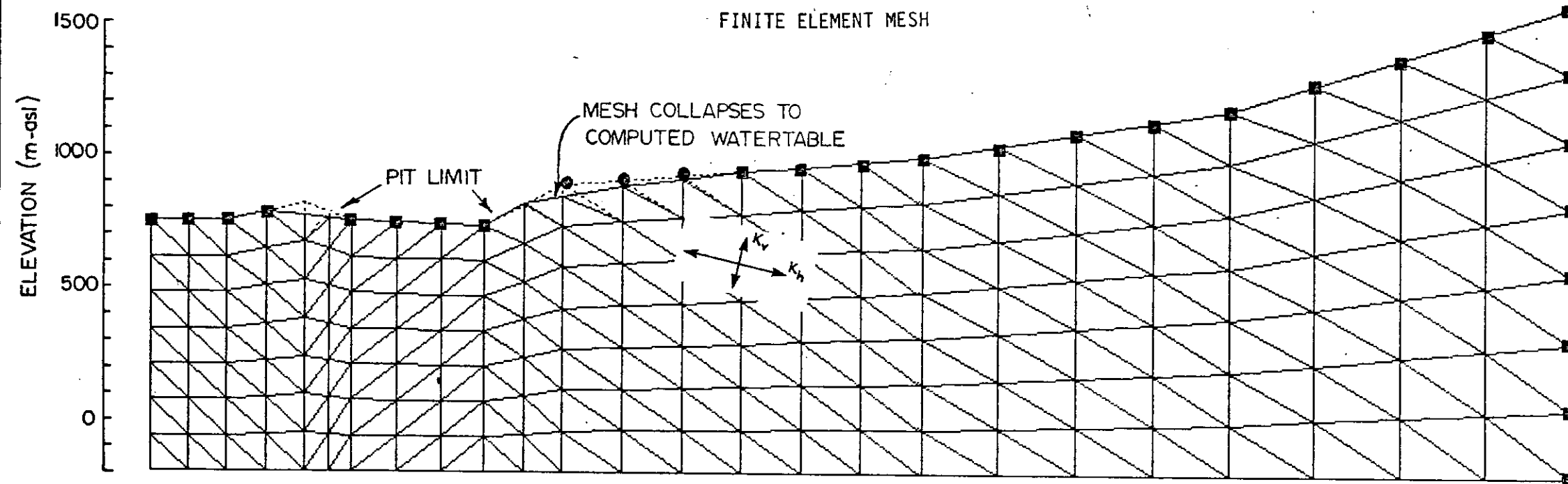

SYMBOLS

- Constant head nodes
- Flux nodes (to simulate infiltration of water from surface)
- ↔ Direction of principal (K_h) and secondary (K_v) permeabilities
- ↑ Computed discharge fluxes
- ▽ Estimated natural water table
- ▽ Computed post mining water table
- ← Groundwater flow direction
- Computed equipotential

Scale 1 cm = 200m

SUMMARY OF MODELLING RESULTS

CASE	HYDRAULIC CONDUCTIVITY (m/s)		COMPUTED FLUX (L/s/m) ⁽¹⁾			Q ₂ (INFLOW TO PIT) AS % OF TOTAL COMPUTED GROUNDWATER DISCHARGE
	K _h	K _v	Q ₁	Q ₂	Q ₃	
I	10 ⁻⁷	10 ⁻⁸	9.5x10 ⁻³	6.2x10 ⁻³	7x10 ⁻⁴	38
II	10 ⁻⁷	3x10 ⁻⁹	1.3x10 ⁻²	4.3x10 ⁻³	5x10 ⁻⁴	25

NOTES: 1. Computed fluxes are for a 1m thick section, hence are in units of L/s/m of thickness.

FIG. 20

QUINTETTE COAL LIMITED DENISON MINES LIMITED SHIKANO DEVELOPMENT		PITEAU & ASSOCIATES GEOTECHNICAL CONSULTANTS VANCOUVER CALGARY	BY: ATH DATE: APR 85
SUMMARY OF MODELLING OF POST MINING GROUNDWATER FLOW ALONG SYNCLINAL SECTION			APPROVED: <i>[Signature]</i> DWG: 339-XA-20

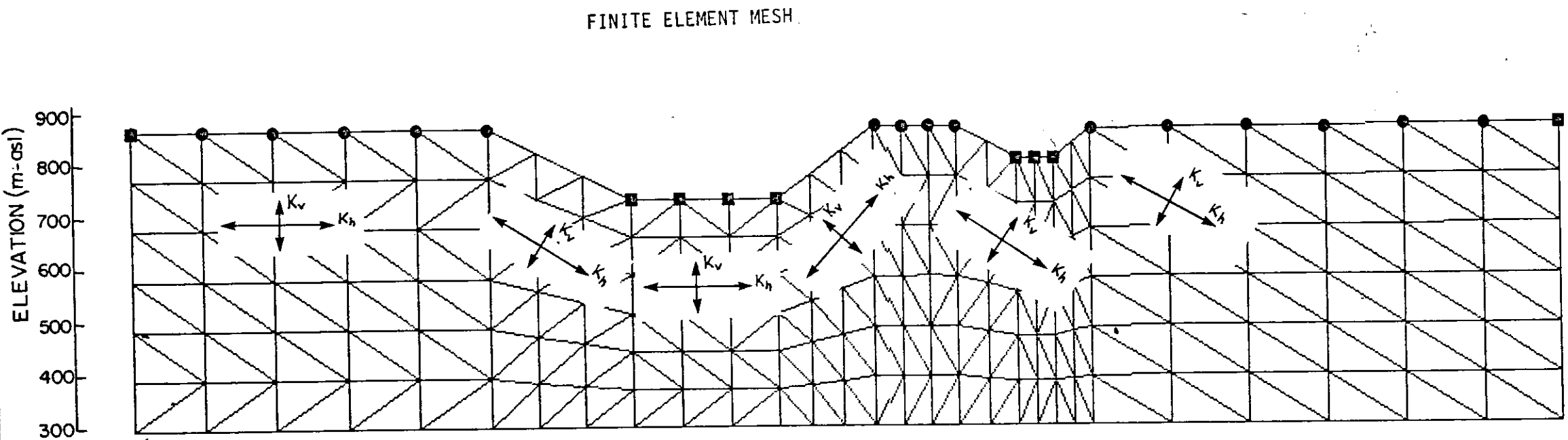

- SYMBOLS
- Constant head nodes
 - Flux nodes (to simulate infiltration of water from surface)
 - ↔ Direction of principal (K_h) and secondary (K_v) permeabilities
 - ↑ Computed discharge fluxes
 - ▽ Estimated natural water table
 - ▽ Computed post mining water table
 - ← Groundwater flow direction
 - Computed equipotential

Scale: 1cm = 100m

PLOT OF COMPUTED EQUIPOTENTIALS
FOR CASE I CONDITIONS

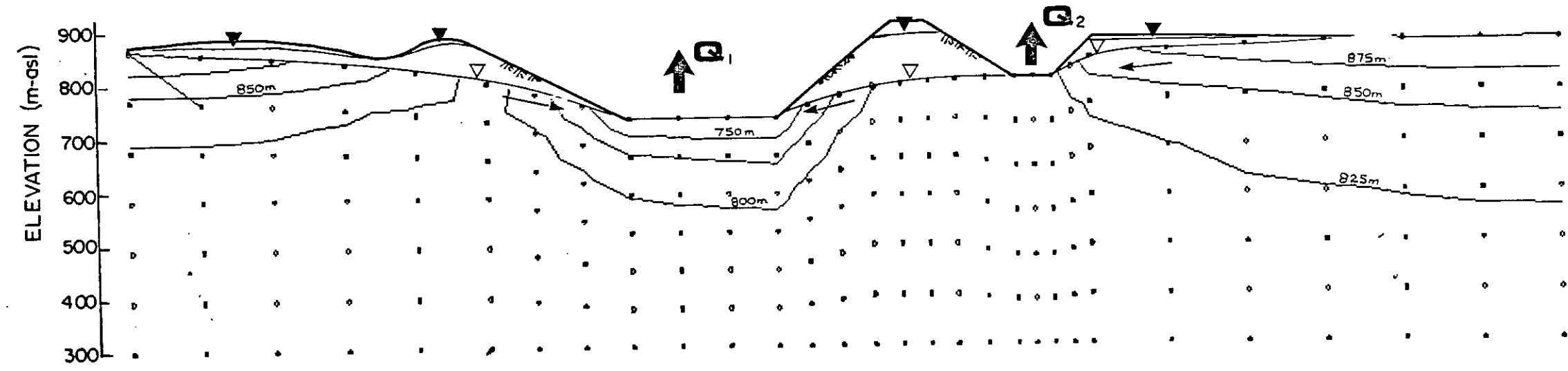

SUMMARY OF MODELLING RESULTS

CASE	HYDRAULIC CONDUCTIVITY (m/s)		COMPUTED FLUX (L/s/m) ⁽¹⁾			TOTAL GROUNDWATER FLOW ⁽²⁾ INTO PIT (L/s)
	K_h	K_v	Q_1	Q_2	$Q_1 + Q_2$	
I	10^{-7}	10^{-8}	.0028	.0008	.0036	2.2
II	10^{-7}	3×10^{-9}	.0017	.0010	.0027	1.6

NOTES: 1. Computed fluxes are for a 1m thick section, hence are in units of L/s/m of thickness.
2. Flow into pit estimated by multiplying computed flux by 600m length of pit over which groundwater inflow could occur.

FIG. 21

QUINTETTE COAL LIMITED DENISON MINES LIMITED SHIKANO DEVELOPMENT		PITEAU & ASSOCIATES GEOTECHNICAL CONSULTANTS VANCOUVER CALGARY	BY: ATH DATE: APR 85
SUMMARY OF STEADY-STATE COMPUTER MODELLING ALONG SECTION 23800			APPROVED: <i>a.s.</i> DWG: 339-x4-21

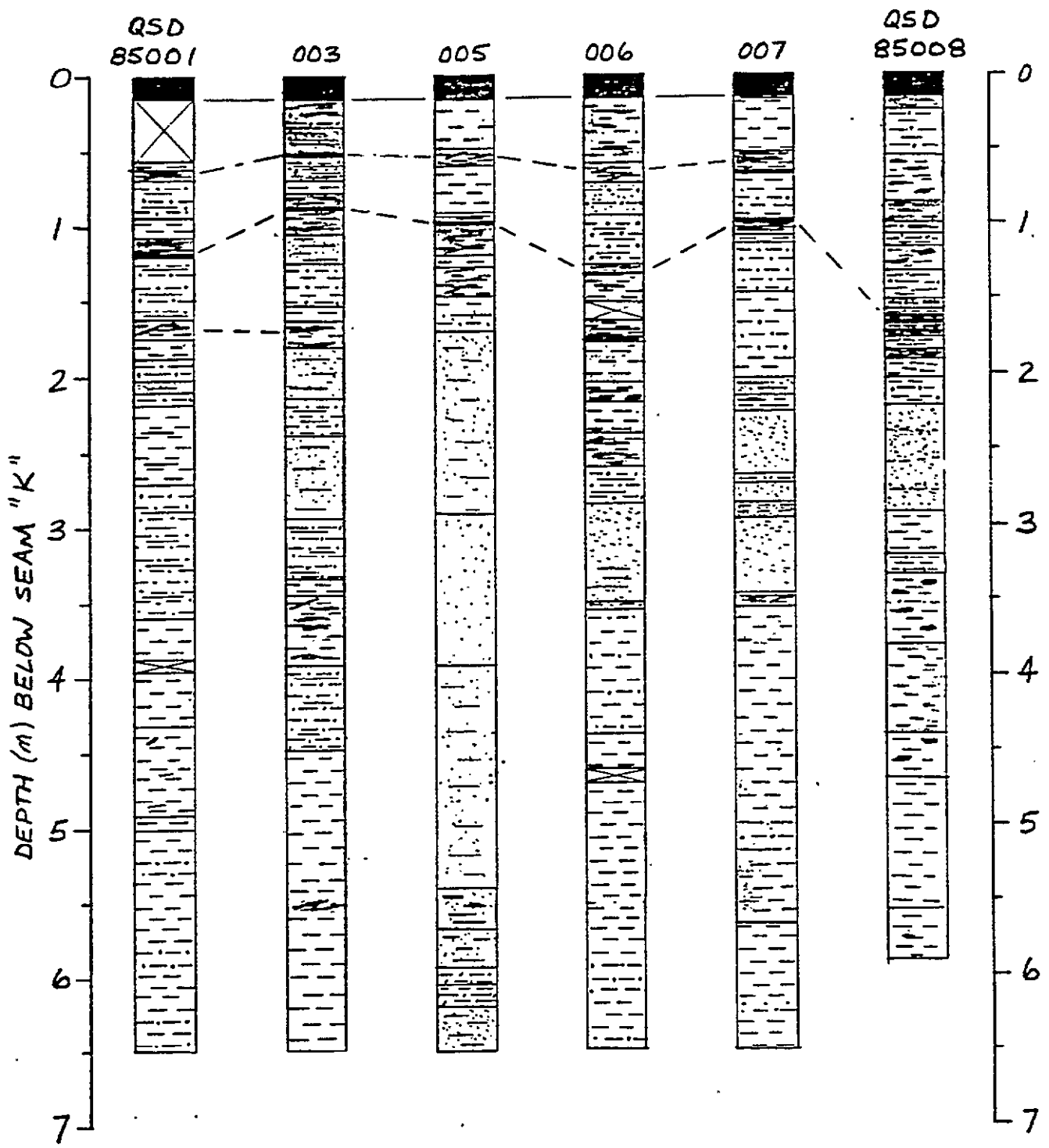

NOTE: Detailed lithology taken from geologic logs provided by Quintette Coal Limited.
 : True thickness of units determined from the cumulative sums analysis of bedding dip as shown in the geotechnical logs in Appendix A.
 : Legend or stratigraphic symbols given in Appendix A.

FIG. 14

QUINETTE COAL LIMITED
 DENISON MINES LIMITED
 SHIKANO DEVELOPMENT



PITEAU & ASSOCIATES
 GEOTECHNICAL CONSULTANTS
 VANCOUVER CALGARY

DETAILED TRUE STRATIGRAPHIC THICKNESS
 GRAPHIC LOGS OF GEOTECHNICALLY LOGGED HOLES

BY: RP	DATE: Apr/85
APPROVED: A.S.	DWG: 339-X4-14

CURVES RELATING MAXIMUM SLOPE HEIGHT AND BEDDING DIP
FOR ESTIMATED ROCK MASS CHARACTERISTICS

BEDDING PLANE FRICTION 26°
ROCK MASS FRICTION 51°
ROCK MASS COHESION 150kPa

F = FACTOR OF SAFETY
T = SLAB THICKNESS DEFINED
BY BEDDING JOINT SPACING

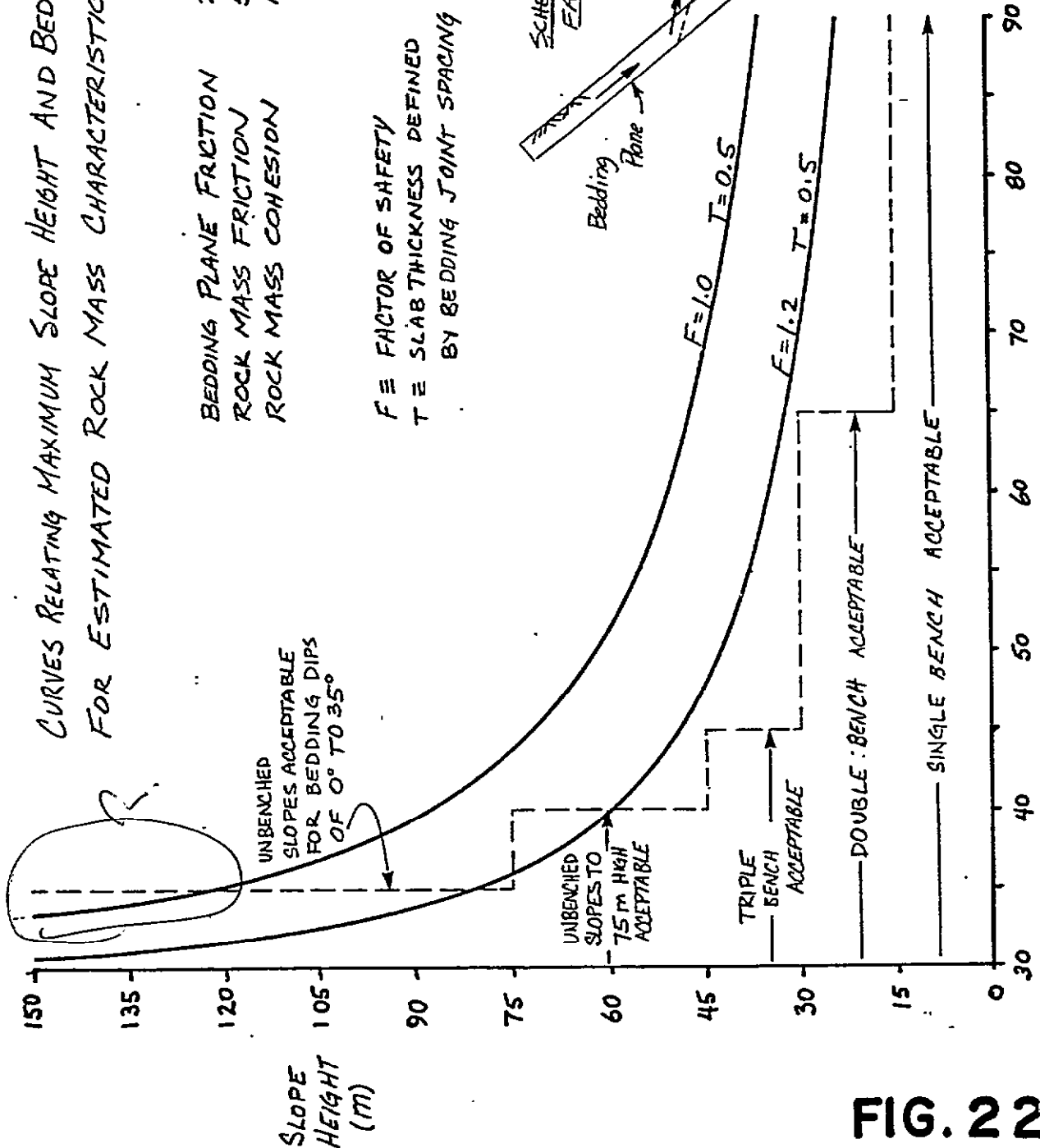

FIG. 22

QUINTETTE COAL LIMITED DENISON MINES LIMITED SHIKANO DEVELOPMENT		PITEAU & ASSOCIATES GEOTECHNICAL CONSULTANTS VANCOUVER CALGARY
RESULTS OF BILINEAR SLAB FAILURE ANALYSIS AND RECOMMENDED BENCH GEOMETRY FOR 15M BENCH INTERVALS IN IMMEDIATE FOOTWALL ROCK		BY: <i>[Signature]</i> DATE: APRIL 85 APPROVED: <i>[Signature]</i> DWG: 339-X4-2.2

CURVES RELATING MAXIMUM SLOPE HEIGHT AND
BEDDING DIP FOR ESTIMATED ROCK MASS
CHARACTERISTICS

BEDDING PLANE FRICTION 34°
ROCK MASS FRICTION 59°
ROCK MASS COHESION 63 kPa

F = FACTOR OF SAFETY
T = SLAB THICKNESS AS DEFINED
BY BEDDING JOINT SPACING

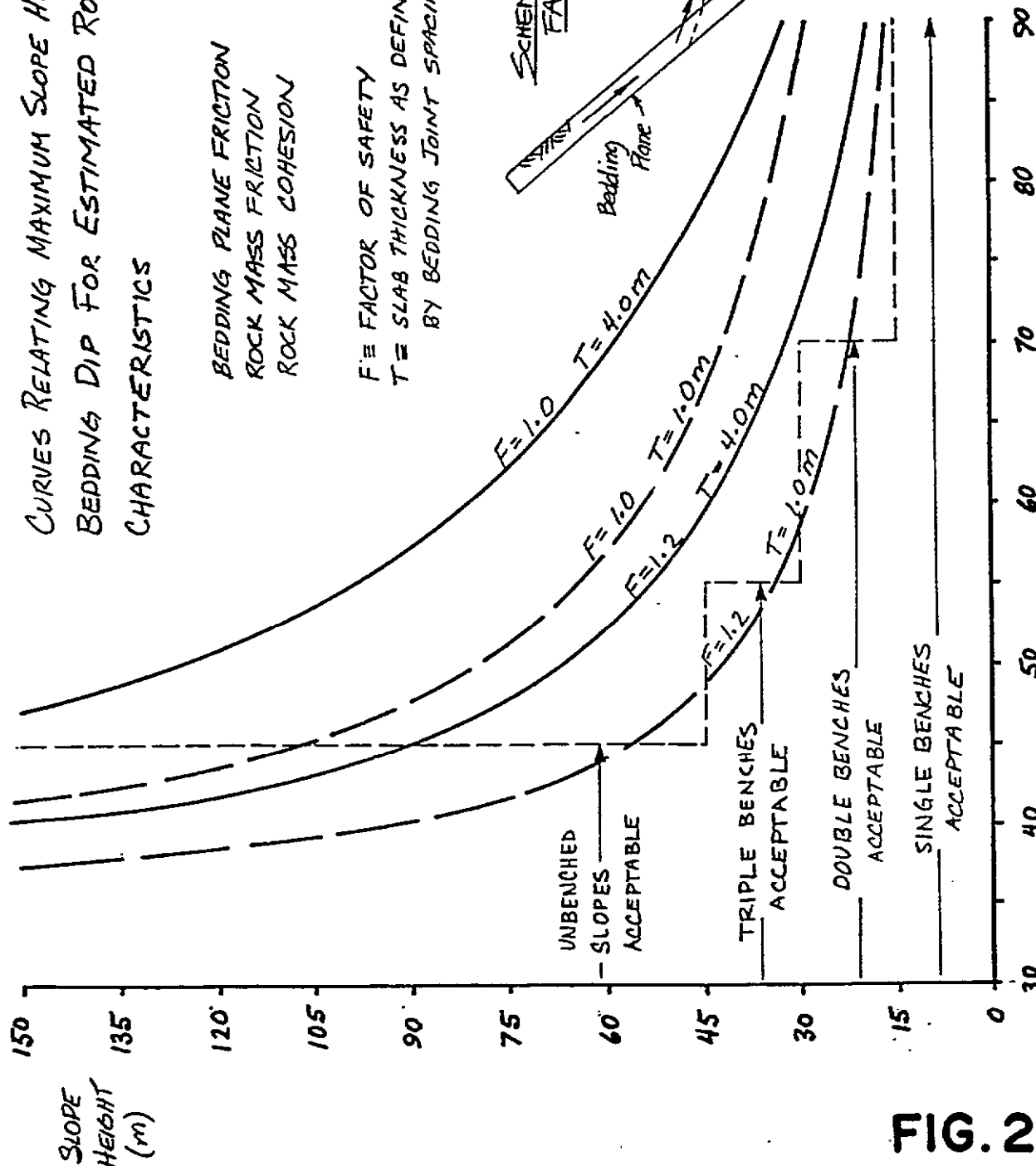
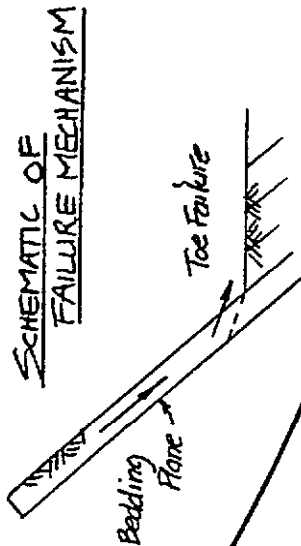

FIG. 23

QUINETTE COAL LIMITED
DENISON MINES LIMITED
SHIKANO DEVELOPMENT



PITEAU & ASSOCIATES
GEOTECHNICAL CONSULTANTS
VANCOUVER CALGARY

RESULTS OF BILINEAR SLAB FAILURE ANALYSIS AND
RECOMMENDED BENCH GEOMETRY FOR 15 m BENCH
INTERVALS IN COMPETENT FOOTWALL ROCK

BY: BST	DATE: APRIL 85
APPROVED: MJK/12.5	DWG: 339-X4-23

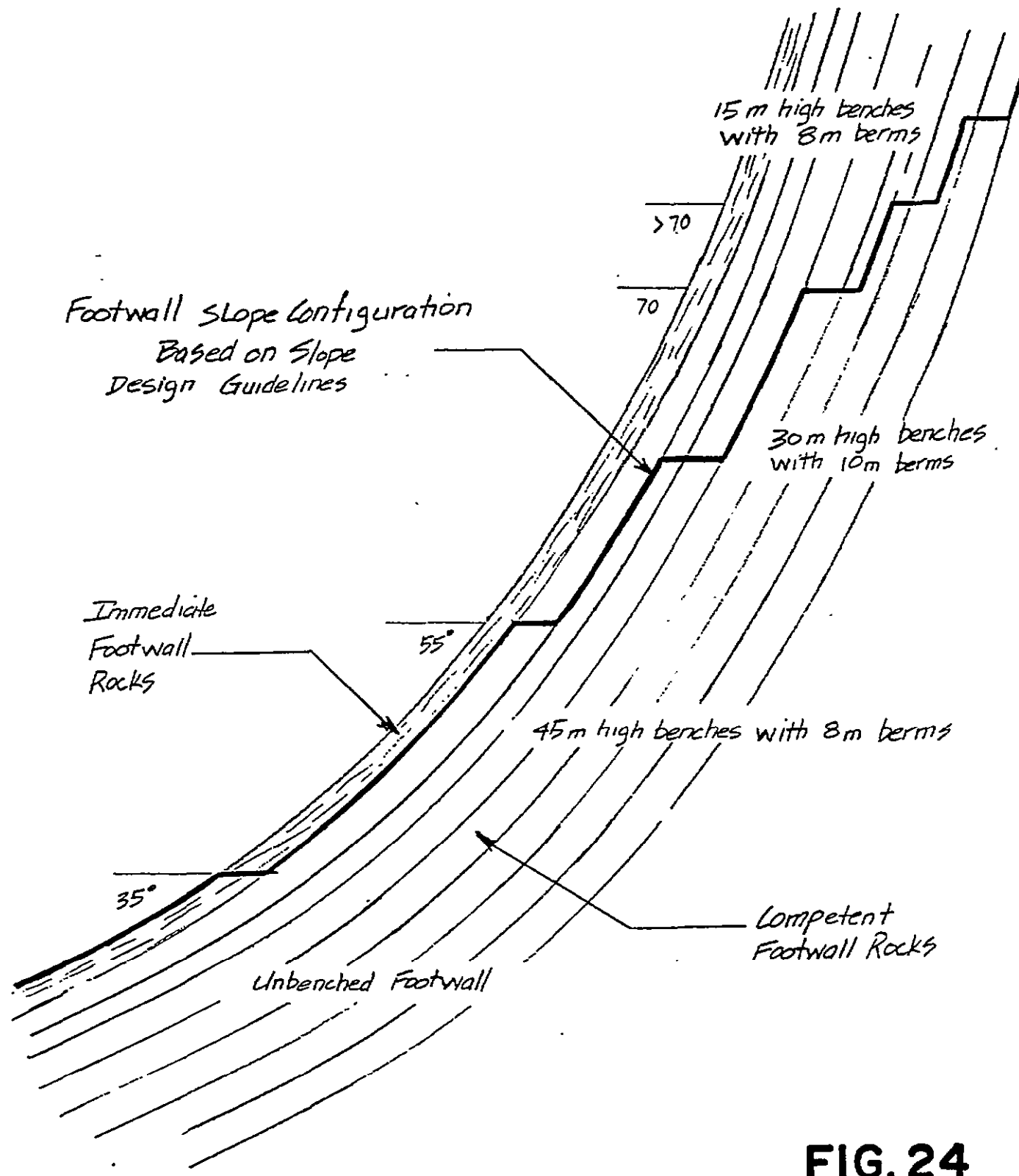

FIG. 24

QUINETTE COAL LIMITED
 DENISON MINES LIMITED
 SHIKANO DEVELOPMENT



PITEAU & ASSOCIATES
 GEOTECHNICAL CONSULTANTS
 VANCOUVER CALGARY

SCHEMATIC OF TYPICAL FOOTWALL SLOPE CONFIGURATION
 BASED ON FOOTWALL SLOPE DESIGN GUIDELINES

BY	DATE
PMH	APR 85
APPROVED	DWG:
<i>A.F.</i>	399-X4-24

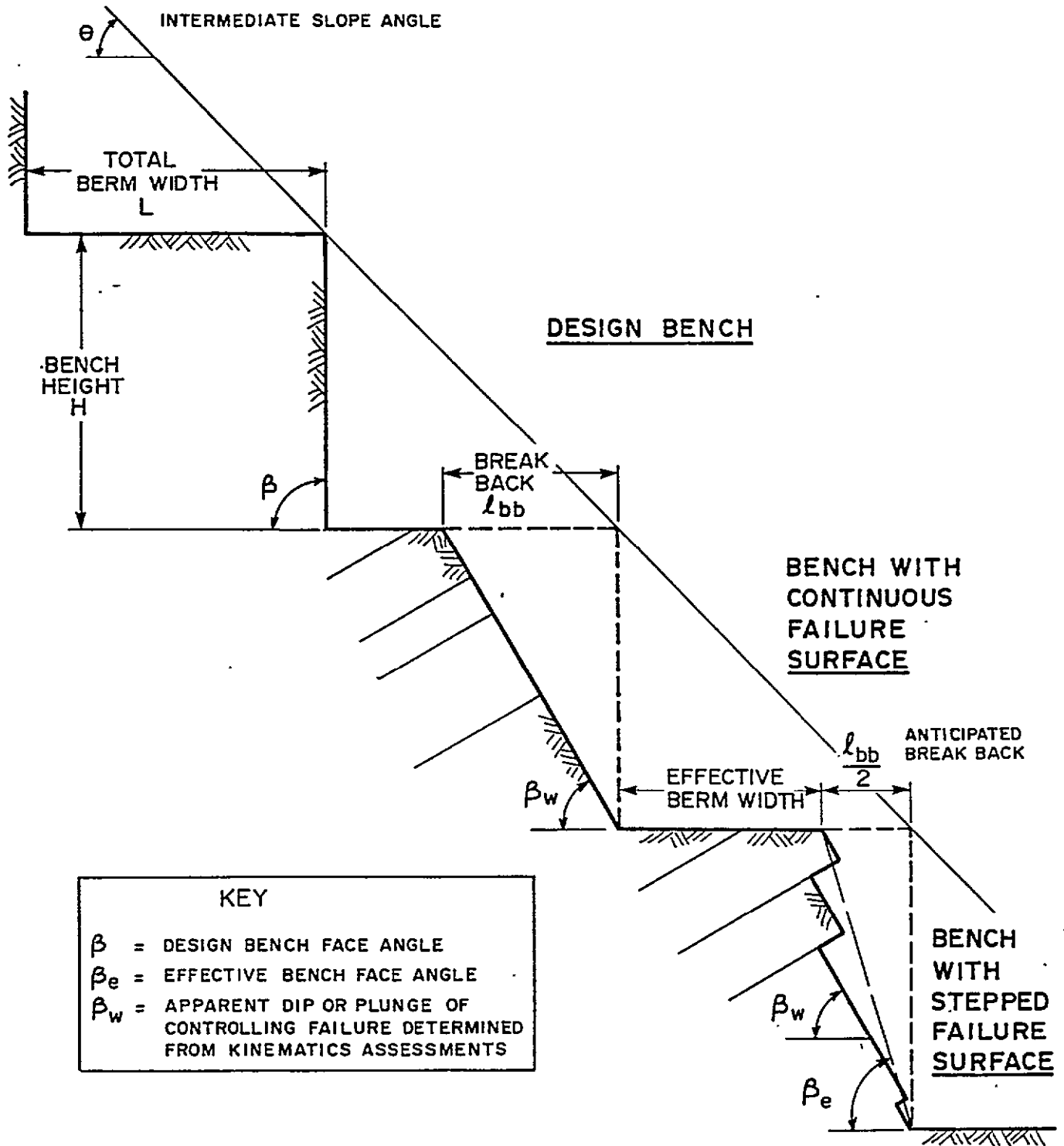

KEY

β = DESIGN BENCH FACE ANGLE

β_e = EFFECTIVE BENCH FACE ANGLE

β_w = APPARENT DIP OR PLUNGE OF CONTROLLING FAILURE DETERMINED FROM KINEMATICS ASSESSMENTS

FIG. 25

QUINETTE COAL LIMITED
DENISON MINES LIMITED
SHIKANO DEVELOPMENT



PITEAU & ASSOCIATES
GEOTECHNICAL CONSULTANTS
VANCOUVER CALGARY

SLOPE GEOMETRY PARAMETERS

BY PTM	DATE: APR 05
APPROVED: <i>[Signature]</i>	DWG: 339-X4-25

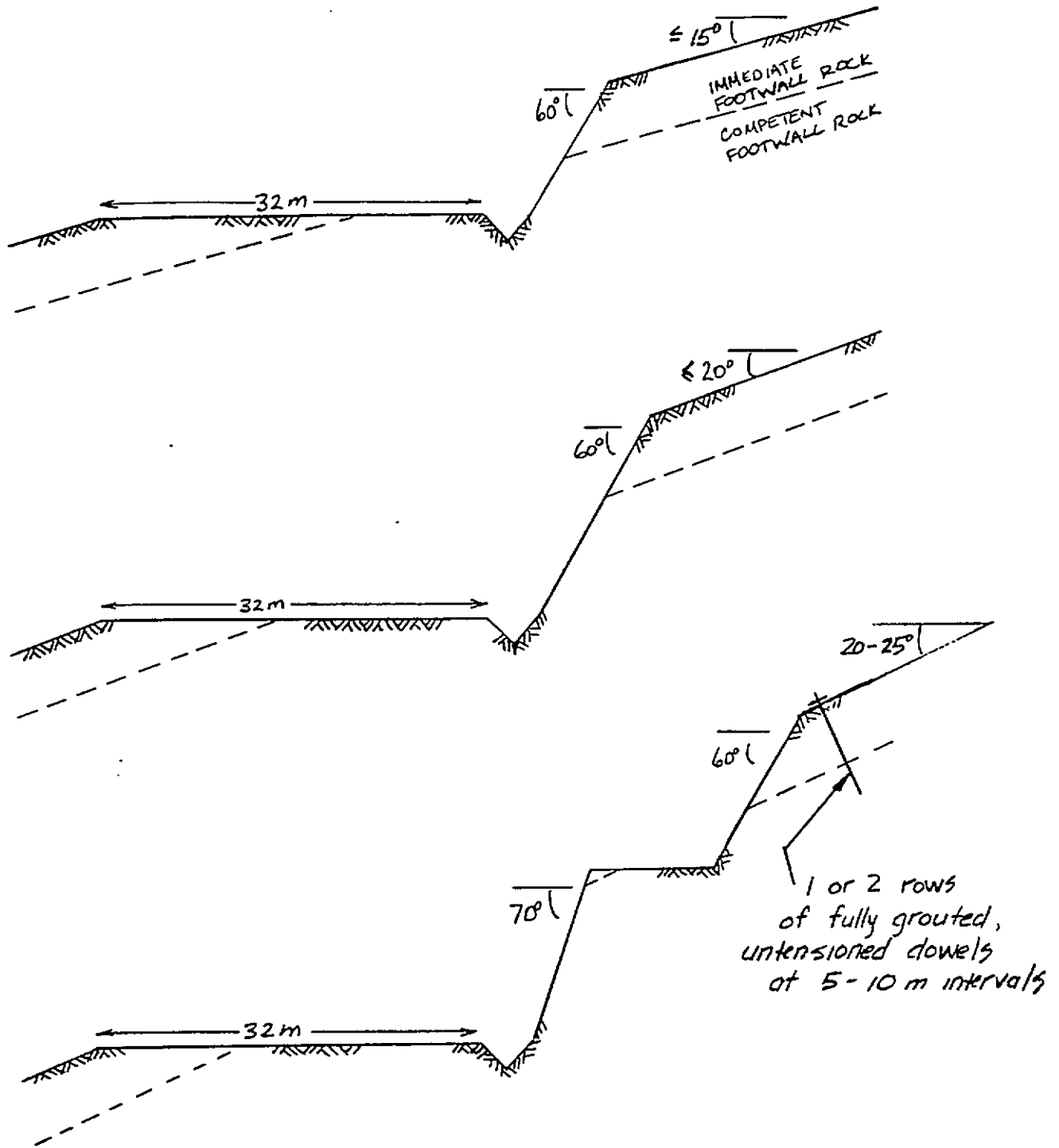

FIG. 26

QUINTETTE COAL LIMITED
 DENISON MINES LIMITED
 SHIKANO DEVELOPMENT



PITEAU & ASSOCIATES
 GEOTECHNICAL CONSULTANTS
 VANCOUVER CALGARY

RECOMMENDED S.W. FOOTWALL RAMP DESIGN

BY: BST	DATE: MAY 85
APPROVED: [Signature]	DWG: 379-XA-26

JOB NUMBER

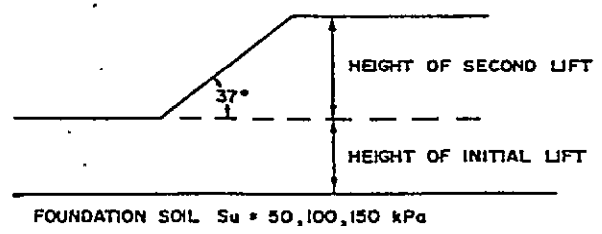
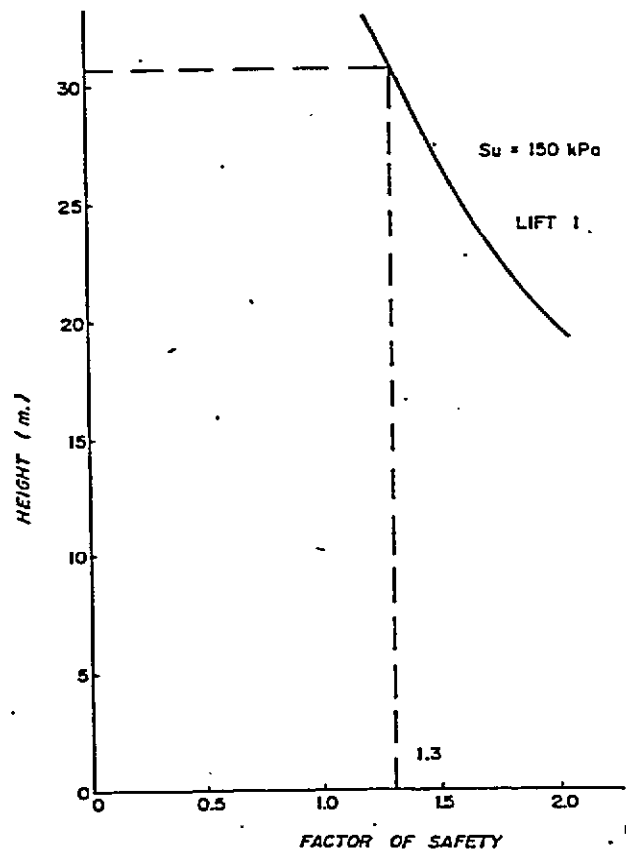
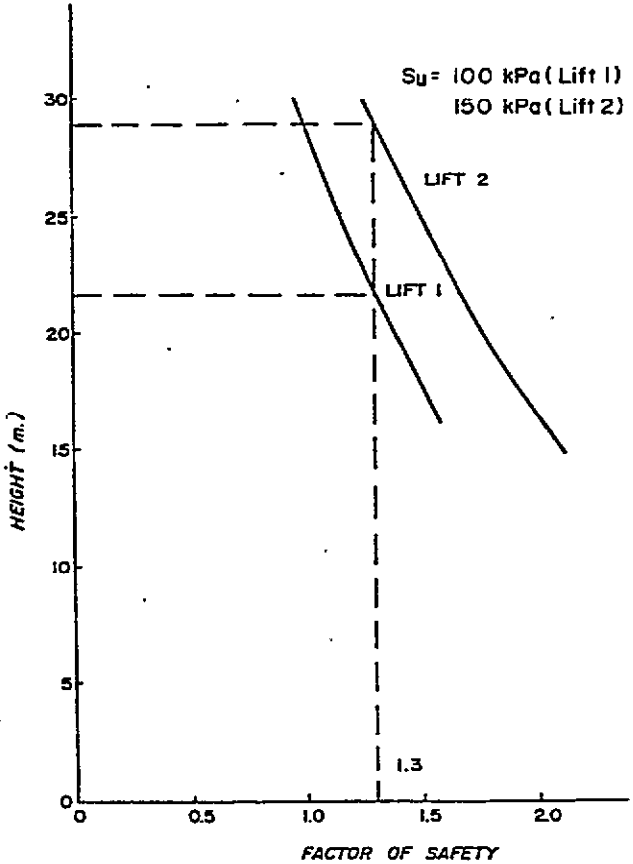
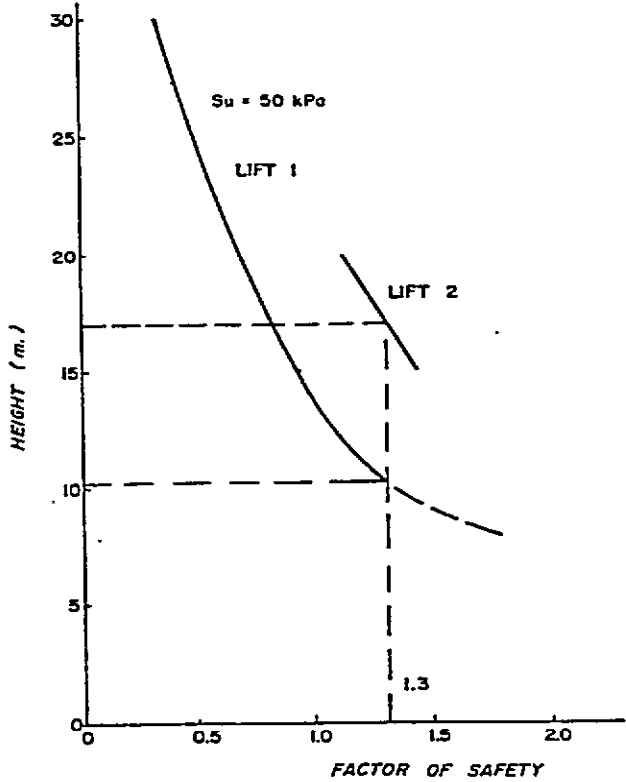

FIG. 27

QUINTETTE COAL LIMITED
DENISON MINES LIMITED
SHIKANO DEVELOPMENT



PITEAU & ASSOCIATES
GEOTECHNICAL CONSULTANTS
VANCOUVER CALGARY

FACTOR OF SAFETY VS. LIFT HEIGHT FOR DIFFERENT FOUNDATION SOIL STRENGTHS

BY:	DATE:
FBC	APR 85
APPROVED:	DWG:
<i>A.S.</i>	399-XA-27

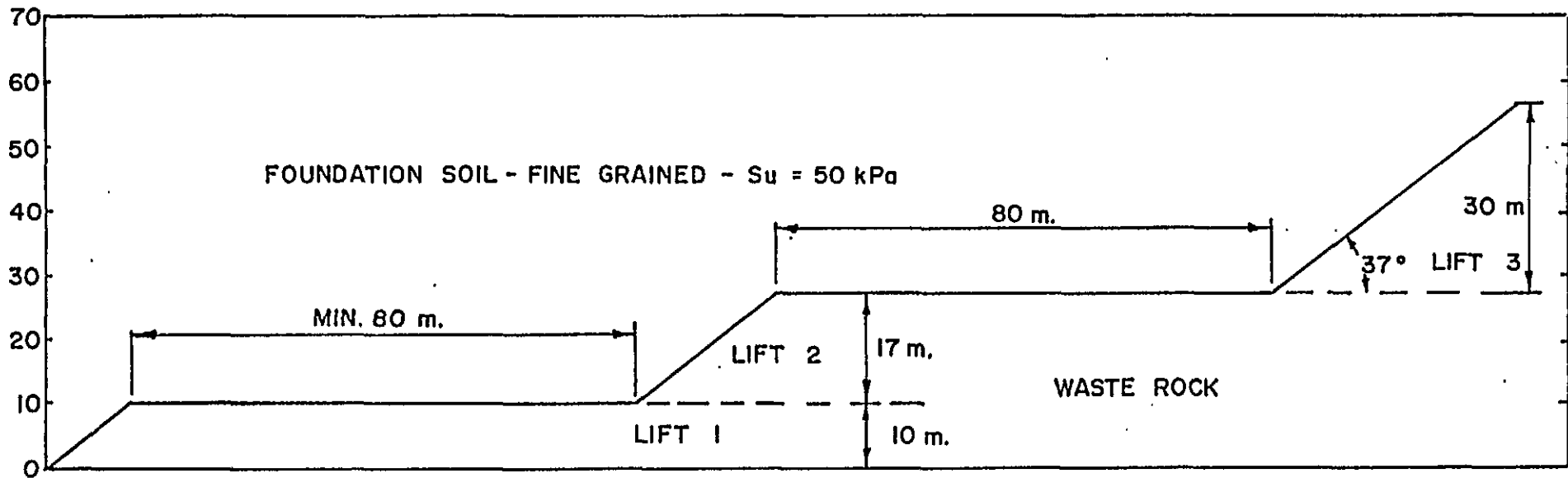
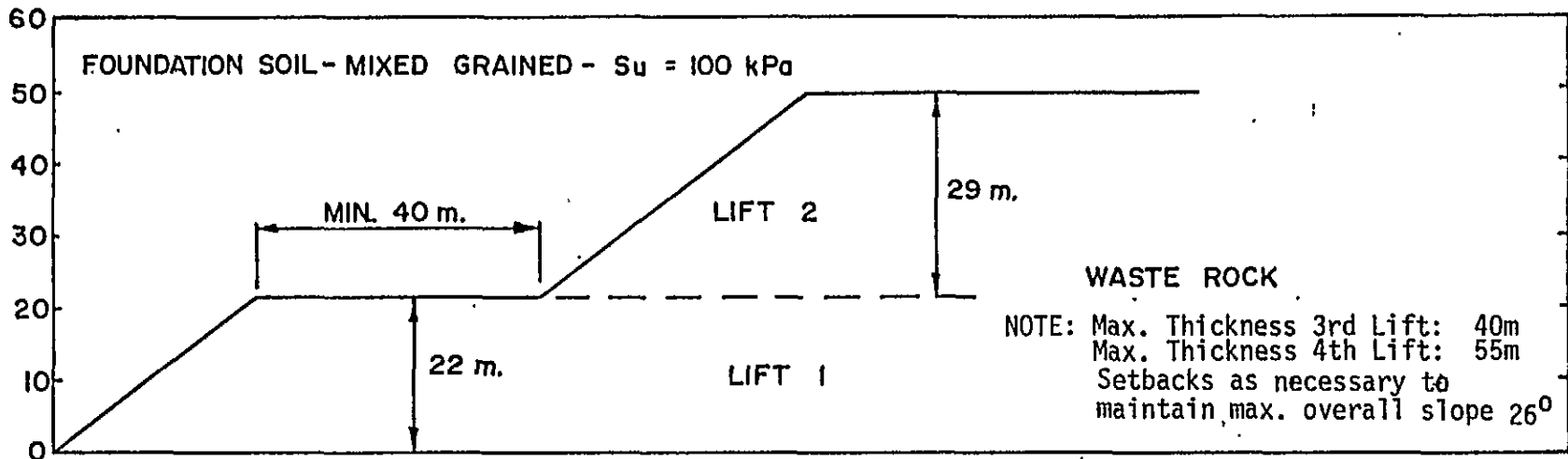

(MINIMUM SAFETY FACTOR = 1.3)

QUINETTE COAL LIMITED
 DENISON MINES LIMITED
 SHIKANO DEVELOPMENT



PITEAU & ASSOCIATES
 GEOTECHNICAL CONSULTANTS
 VANCOUVER CALGARY

FIG. 28

MAXIMUM LIFT THICKNESS AND MINIMUM SETBACKS

FBC

APR 85

E.T.

399-X1-28