





APPENDIX II  
GRAPHIC REPRESENTATION OF 30 TRENCHES

## LEGEND

### TO ACCOMPANY TRENCH REPORTS

	COAL
	SHALE
	SANDSTONE
	MUDSTONE
	ALLUVIUM

NOTE: Seam thicknesses shown  
are stratigraphic.

SUKUNKA PROJECT TRENCH REPORT

T-1-75

STRIKE 330

DIP 43 SW

TRENCH BEARING 320

LENGTH 175

LOCATION: D 43B 93 P5

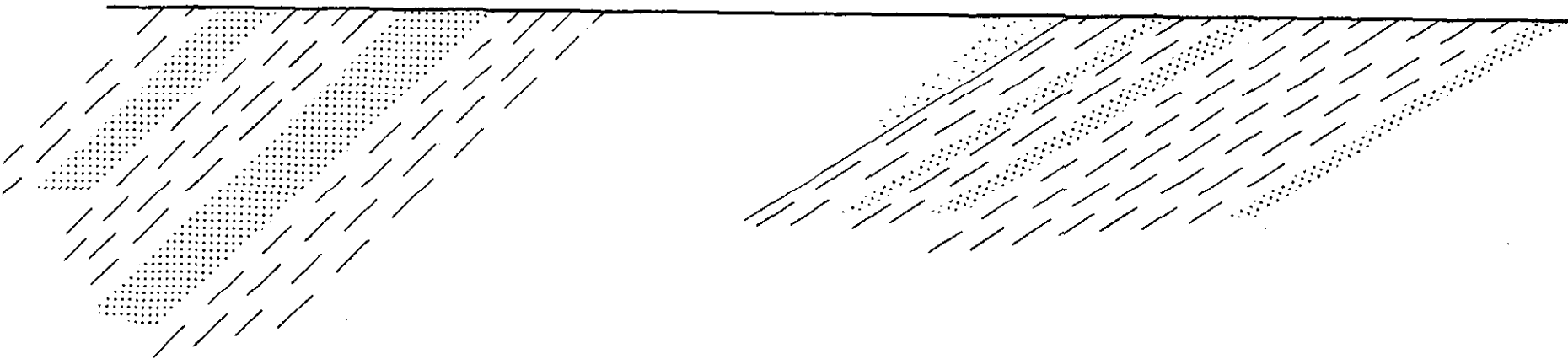

not drawn to scale



STRIKE 296

LOCATION: D32B 93P5

DIP 26 SW

TRENCH BEARING 300

LENGTH 32

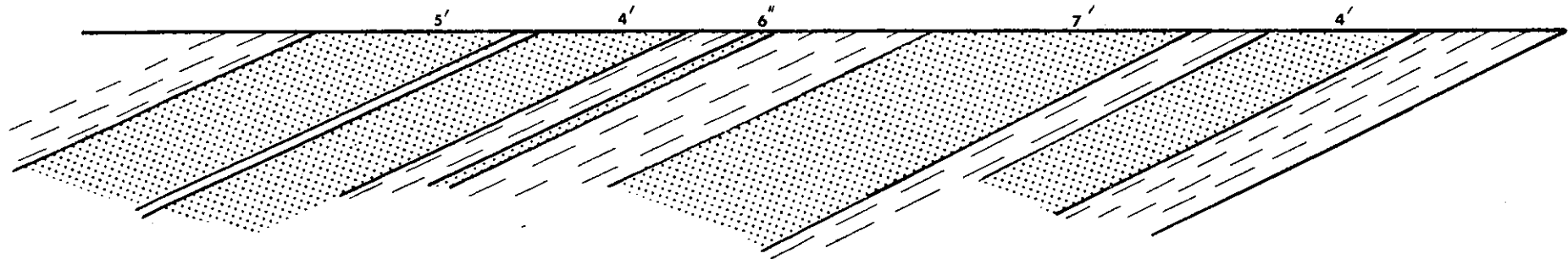

not drawn to scale

STRIKE 301

LOCATION: D42 B 93P5

DIP 27NE

TRENCH BEARING 320

LENGTH 160'

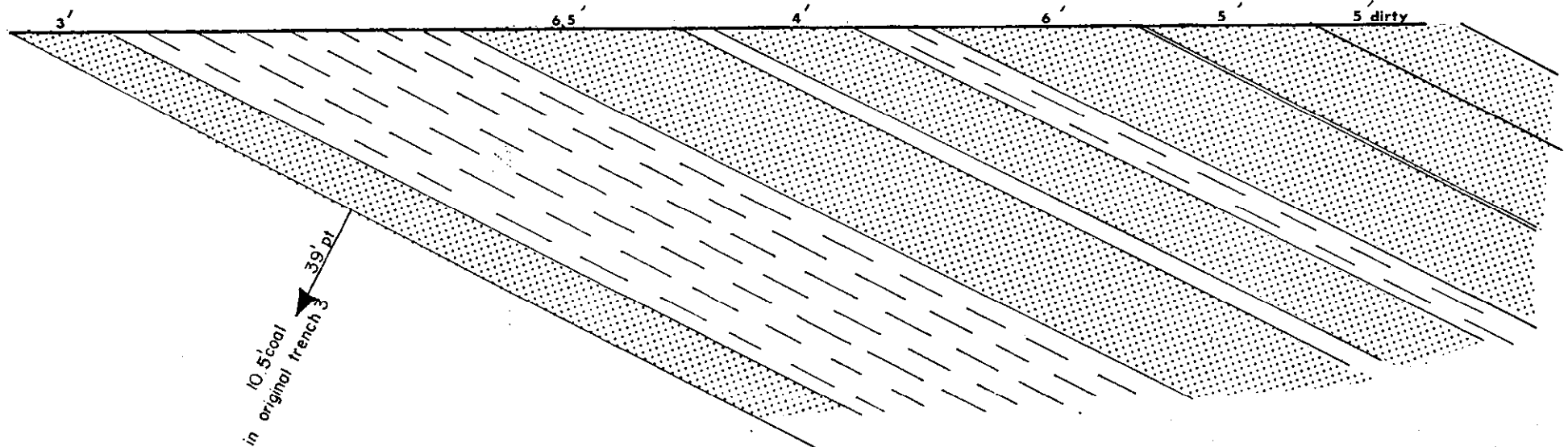

not drawn to scale

# SUKUNKA PROJECT TRENCH REPORT

T-4-75

LOCATION: D32B 93P5

STRIKE 255  
DIP 5 NE  
TRENCH BEARING 360  
LENGTH 6

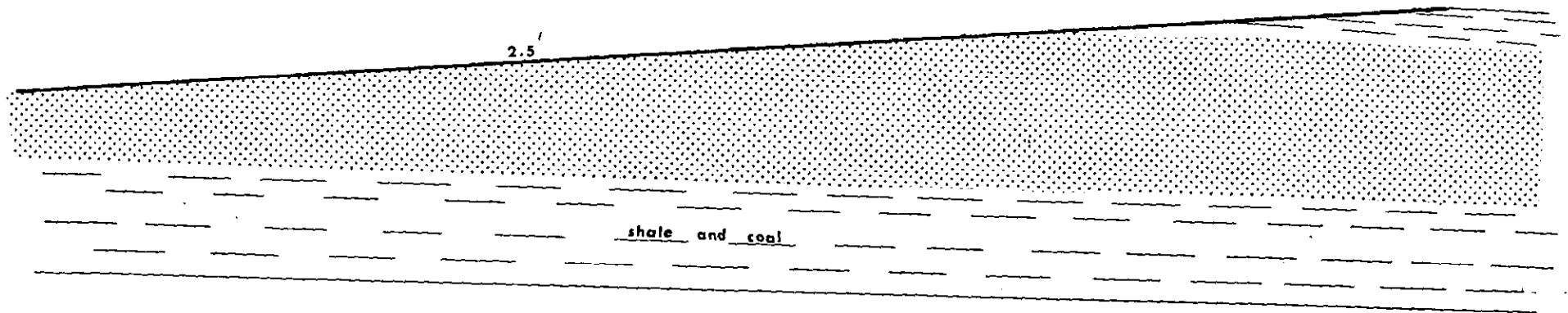

not drawn to scale

SUKUNKA PROJECT TRENCH REPORT

T-5-75

STRIKE 312

DIP 26SW

TRENCH BEARING 310

LENGTH 8'

LOCATION: C40A 93P5

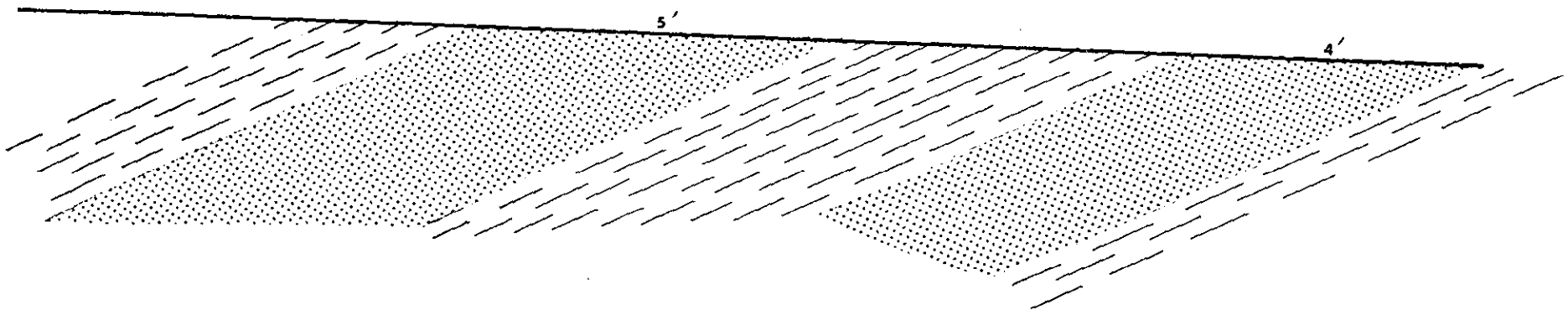

not drawn to scale

# SUKUNKA PROJECT TRENCH REPORT

T-6-75

STRIKE 304

LOCATION: C 40 A 93P5

DIP 35 SW

TRENCH BEARING 305

LENGTH 7

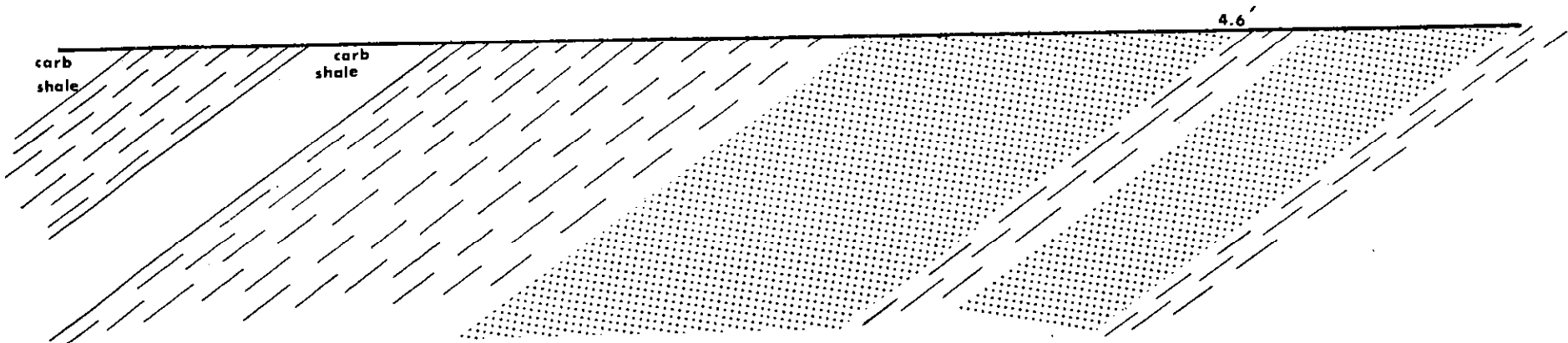

not drawn to scale



SUKUNKA PROJECT TRENCH REPORT

T-7-75

STRIKE 314

DIP 28 SW

TRENCH BEARING 310

LENGTH 12

LOCATION: A 41B 93P5

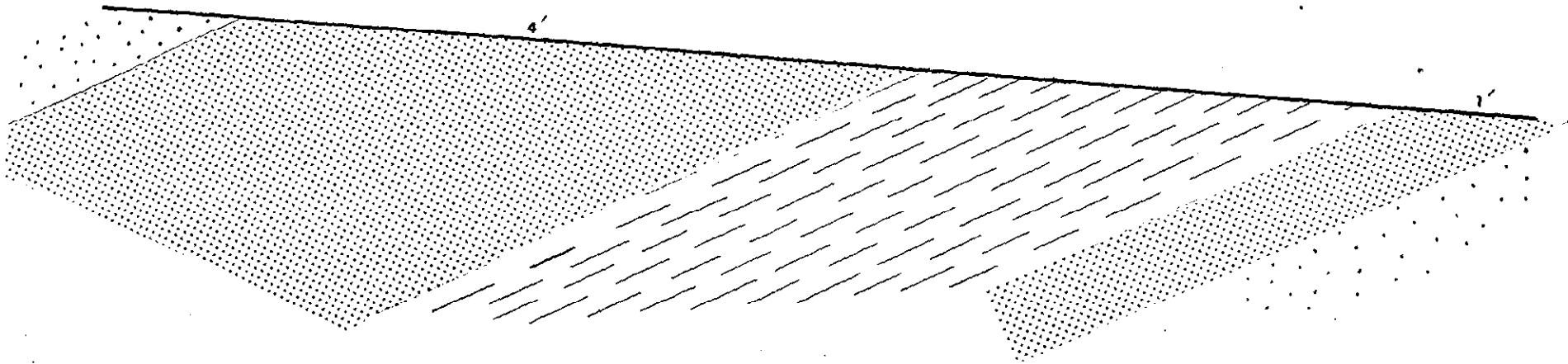

not drawn to scale

STRIKE 310

LOCATION: C 39A 93P5

DIP 47SW

TRENCH BEARING 220

LENGTH 30

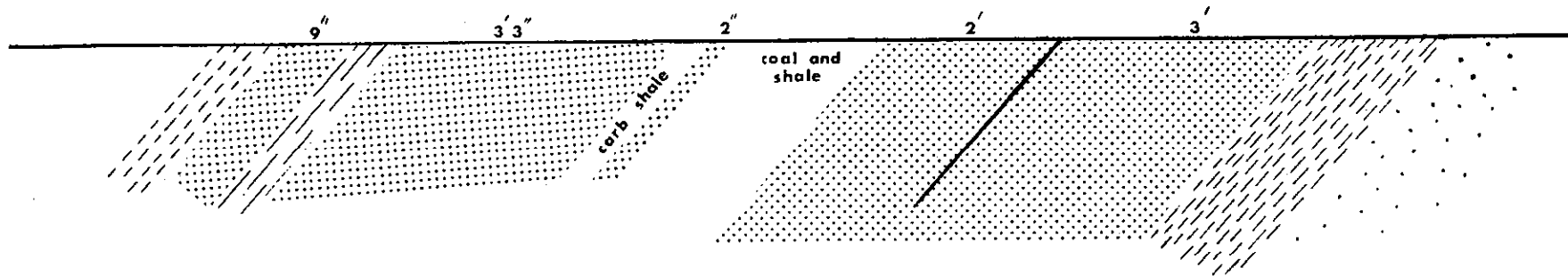

SUKUNKA PROJECT TRENCH REPORT

T- 9 -75

STRIKE 308

LOCATION: A 38A 93P5

DIP 62SW

TRENCH BEARING 220

LENGTH 6

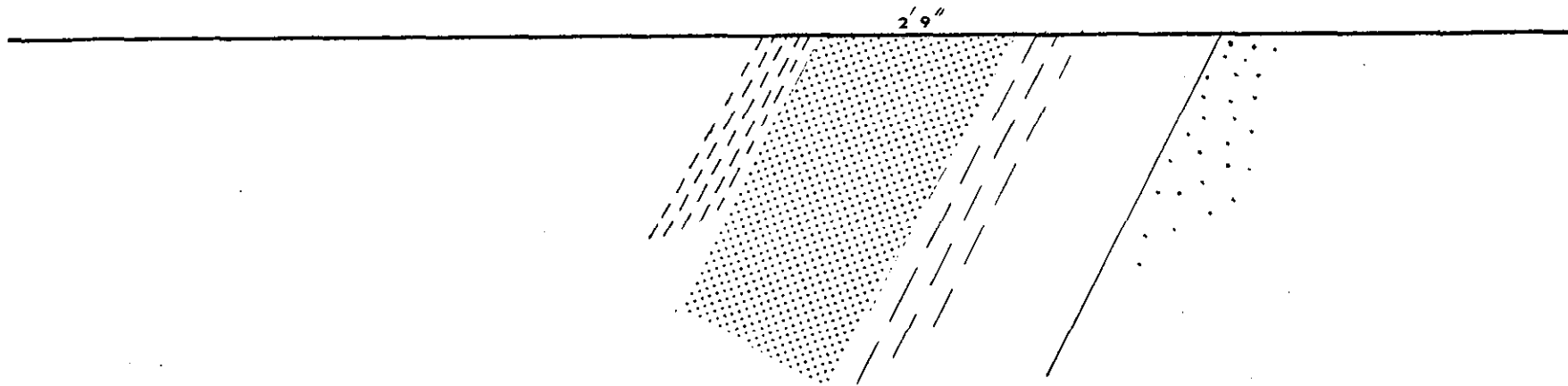

not drawn to scale

STRIKE 313

LOCATION: C28A 93P5

DIP 56 SW

TRENCH BEARING 295

LENGTH 21

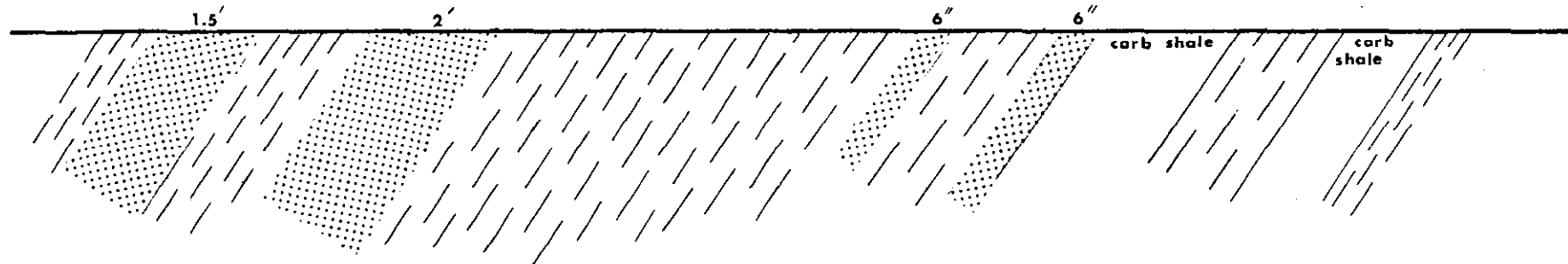

not drawn to scale

STRIKE 296

DIP 41 SW

TRENCH BEARING 318

LENGTH 20

LOCATION: C 18A 93P5

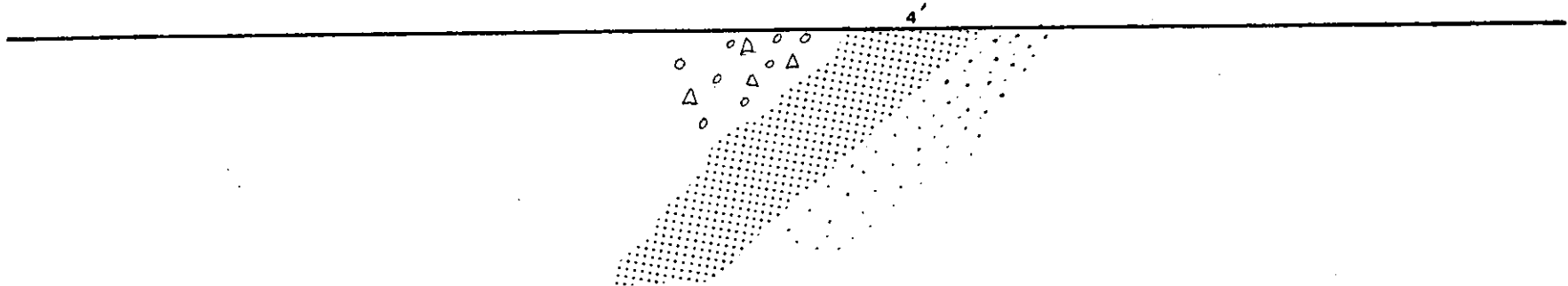

SUKUNKA PROJECT TRENCH REPORT

T-12-75

STRIKE 304

LOCATION: B17A 93P5

DIP 25 SW

TRENCH BEARING 360

LENGTH 1450

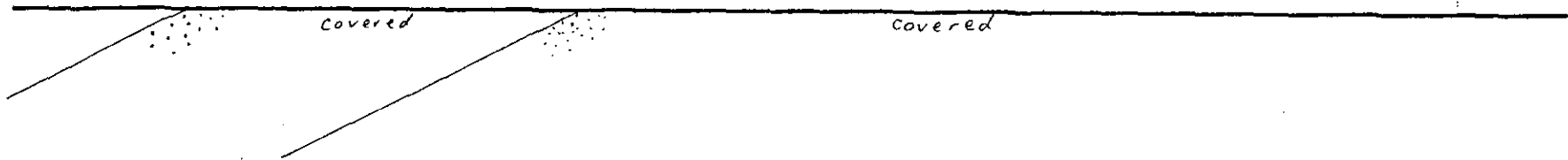

not drawn to scale

SUKUNKA PROJECT TRENCH REPORT

T-13-75

STRIKE 310

LOCATION: D 1B 93P5

DIP 25SW

TRENCH BEARING 210

LENGTH 150

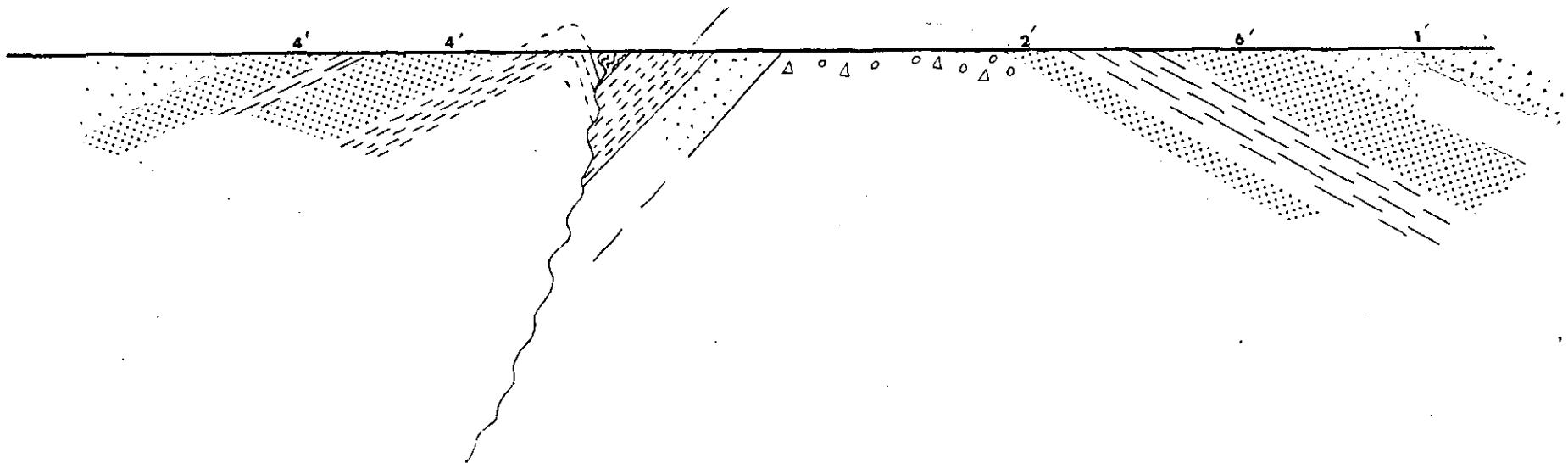

not drawn to scale





SUKUNKA PROJECT TRENCH REPORT

T-15 -75

STRIKE  
DIP NO O.C.

LOCATION: A 43B 93P5

TRENCH BEARING 360  
LENGTH 275

---

not drawn to scale

STRIKE 310

LOCATION: B 53 B 93 P 5

DIP 14 SW

TRENCH BEARING 310

LENGTH 10

Looking S.E. this section

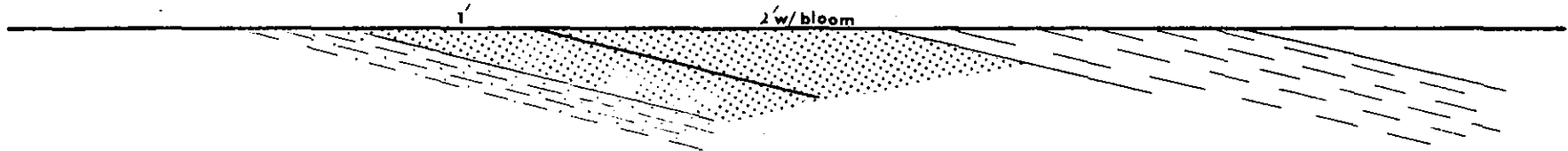

SUKUNKA PROJECT TRENCH REPORT

T-17-75

STRIKE

DIP NO O.C.

TRENCH BEARING 233

LENGTH 280

LOCATION: C 8A 93P5



SUKUNKA PROJECT TRENCH REPORT

T-18 -75

STRIKE 310

LOCATION: D28A 93P5

DIP 30NE

TRENCH BEARING 350

LENGTH 375

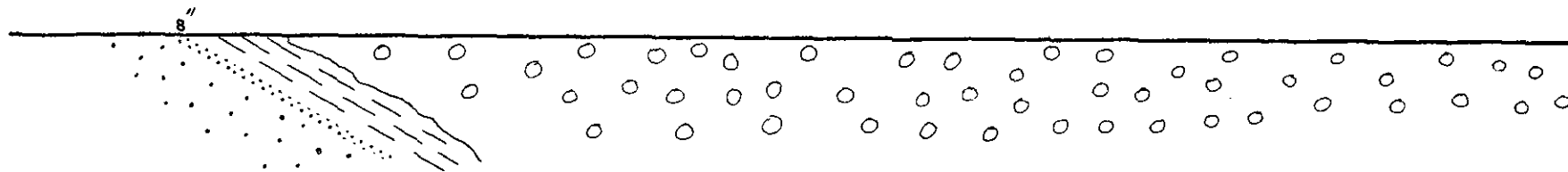

not drawn to scale

SUKUNKA PROJECT TRENCH REPORT

T-19 -75

STRIKE 300

DIP 21 SW

TRENCH BEARING 315

LENGTH 8

LOCATION: D32B 93P5

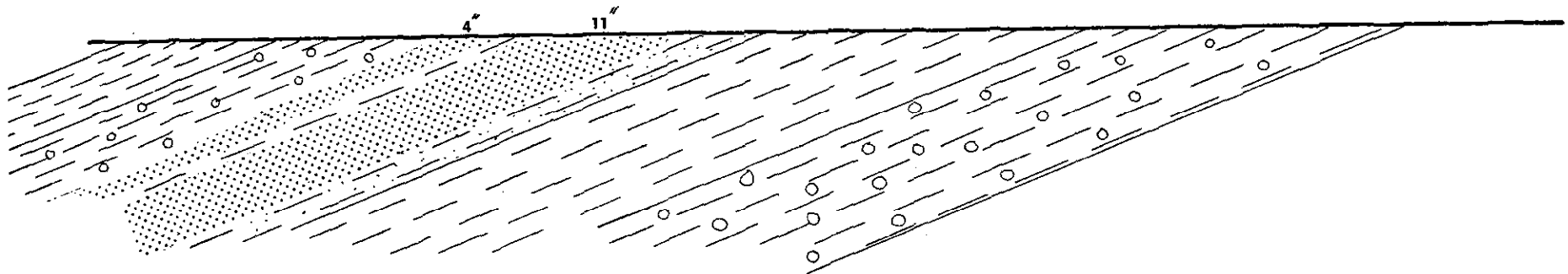

not drawn to scale

SUKUNKA PROJECT TRENCH REPORT

T-20-75

STRIKE 315

LOCATION: D 40A 93P5

DIP 87 NE

TRENCH BEARING 311

LENGTH 1070

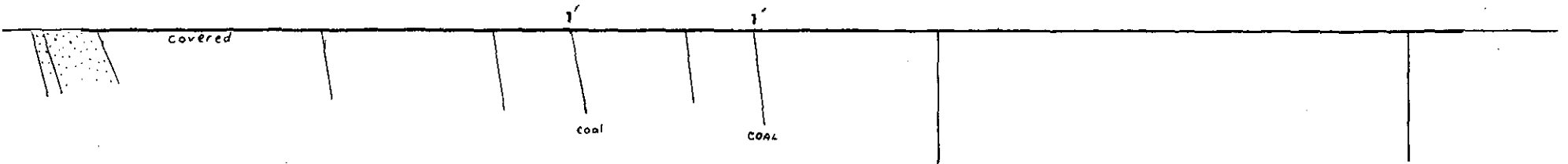

not drawn to scale

SUKUNKA PROJECT TRENCH REPORT

T-21-75

STRIKE 295

DIP 17NE

TRENCH BEARING 035

LENGTH 17

LOCATION: D 52B 93P5

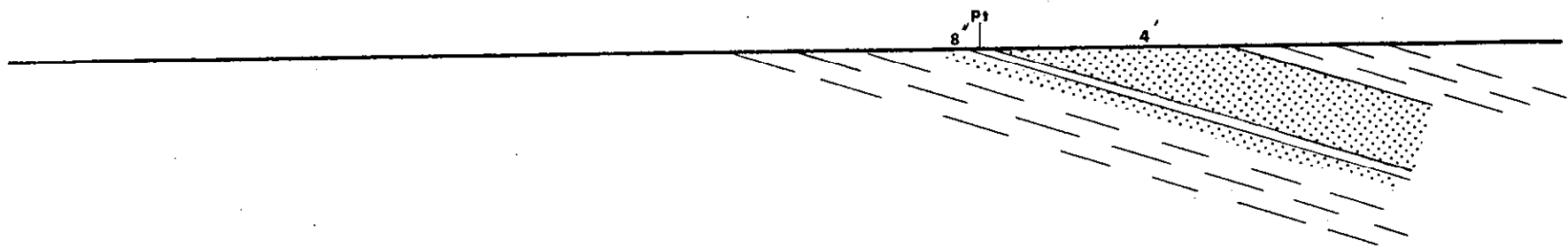

not drawn to scale

# SUKUNKA PROJECT TRENCH REPORT

T-22-75

STRIKE 310

DIP 65SW

TRENCH BEARING 027

LENGTH 35

LOCATION: B52 B 93P5

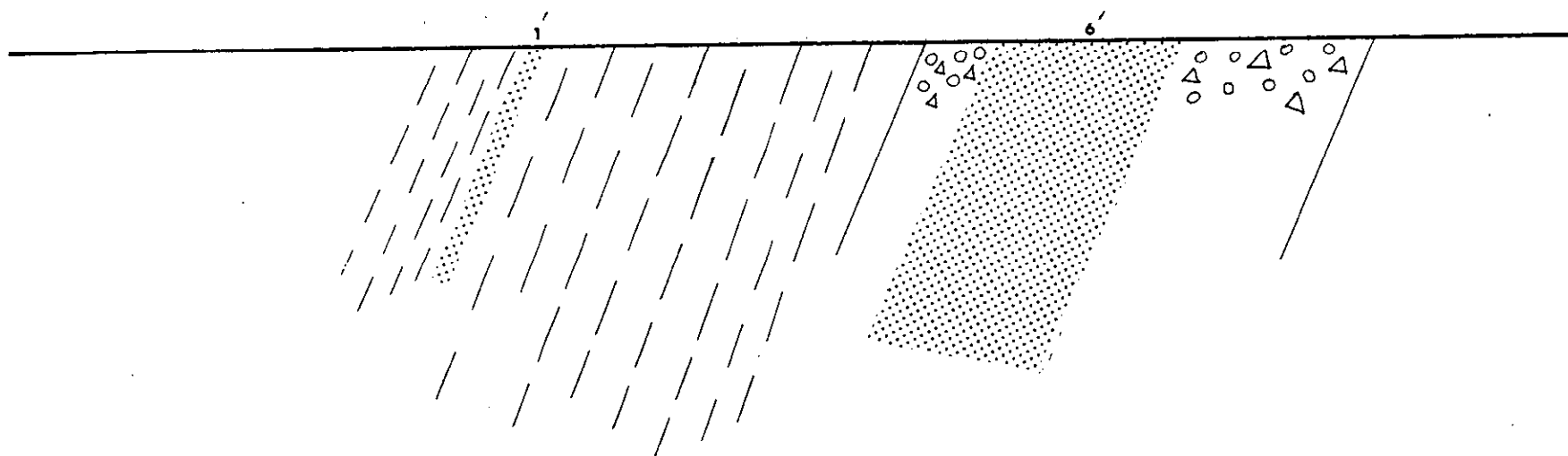

not drawn to scale



SUKUNKA PROJECT TRENCH REPORT

T-23 -75

STRIKE 115

DIP 20SW

TRENCH BEARING 040

LENGTH 355

LOCATION: A12B 93P5

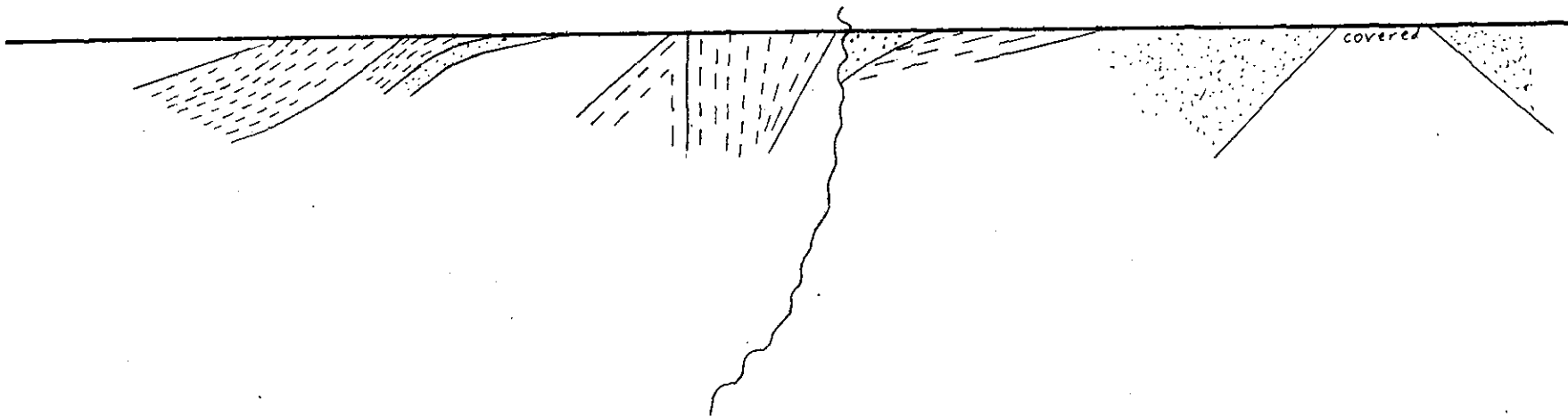

not drawn to scale

# SUKUNKA PROJECT TRENCH REPORT

T-24-75

STRIKE 306

LOCATION: B 61B 93P5

DIP 67 SW

TRENCH BEARING 270

LENGTH 365

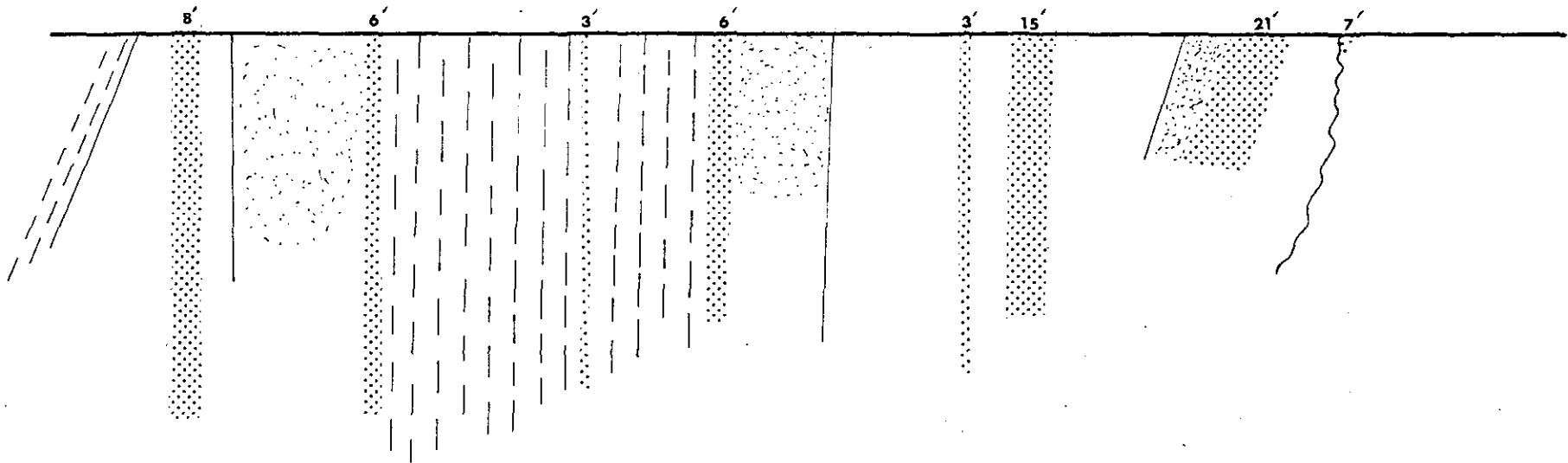

not drawn to scale

SUKUNKA PROJECT TRENCH REPORT

T-25-75

STRIKE 132

LOCATION: B,C 61B 93P5

DIP 70 NE

TRENCH BEARING 330

LENGTH 3435

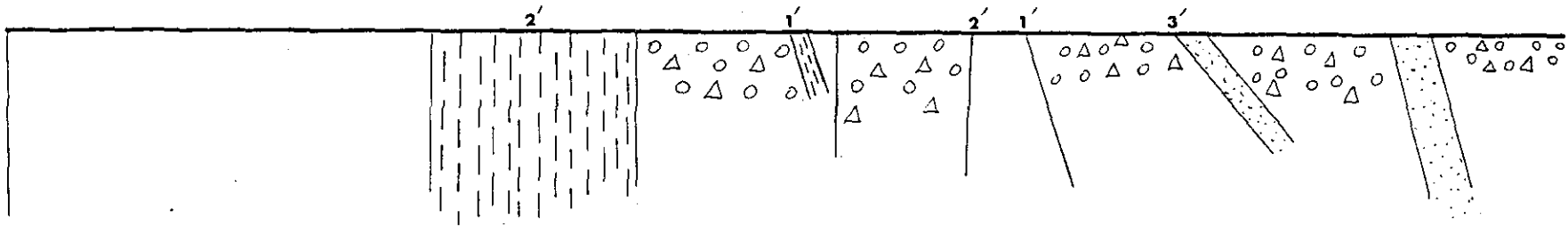

not drawn to scale

SUKUNKA PROJECT TRENCH REPORT

T-26-75

STRIKE  
NO O.C.  
DIP  
TRENCH BEARING 045  
LENGTH 1400

LOCATION: A 65 B 93 P5

# SUKUNKA PROJECT TRENCH REPORT

T-27-75

STRIKE 305  
DIP 25 SW  
TRENCH BEARING 005  
LENGTH 60

LOCATION: C 40A 93 P5

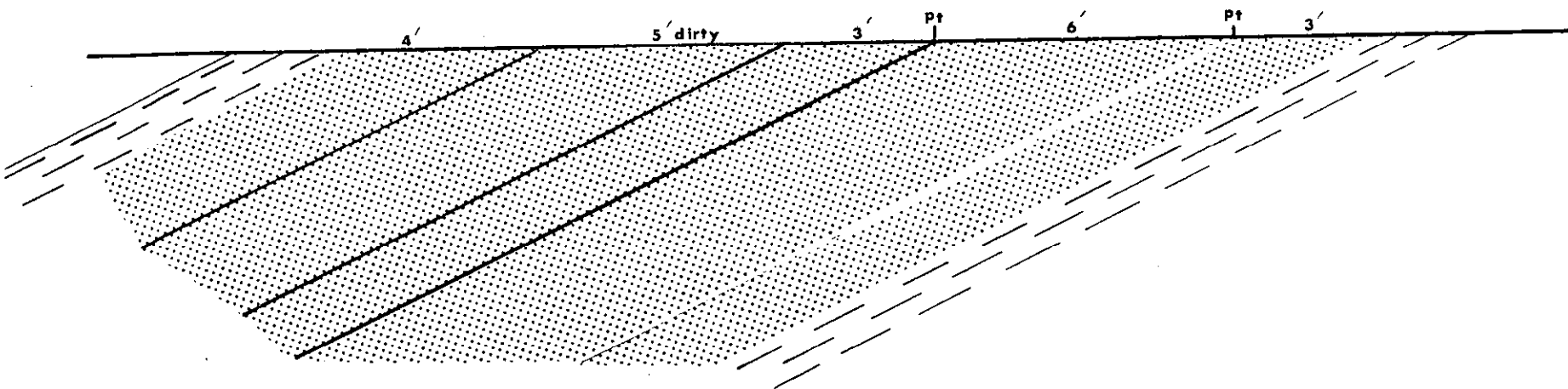

not drawn to scale

SUKUNKA PROJECT TRENCH REPORT

T-28-75

STRIKE

NEARLY FLAT

DIP SLIGHTLY SW

TRENCH BEARING 310

LENGTH 150

LOCATION: D 31 B 93P5

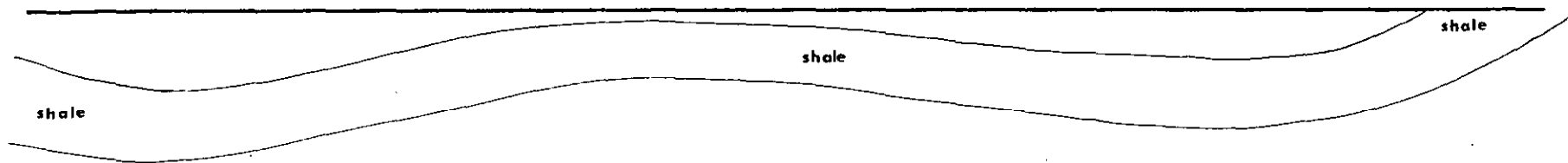

not drawn to scale

SUKUNKA PROJECT TRENCH REPORT

T-29-75

STRIKE 305

LOCATION: B31B 93P5

DIP 36SW

TRENCH BEARING 347

LENGTH 400

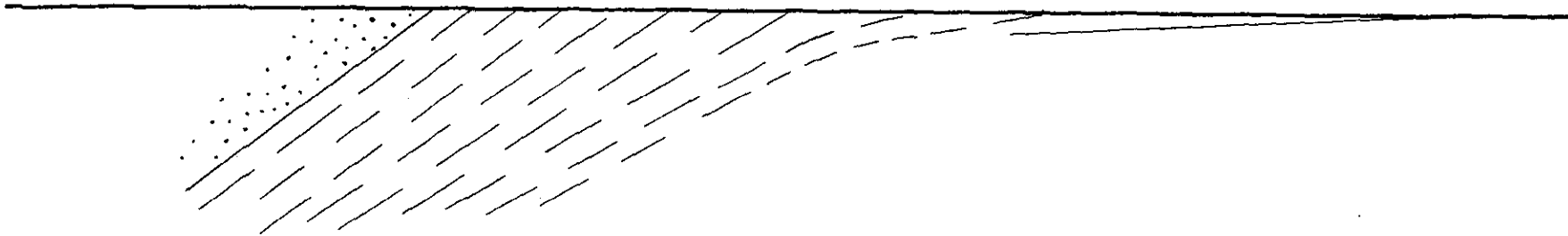

not drawn to scale

SUKUNKA PROJECT TRENCH REPORT

T-30-75

STRIKE 310

LOCATION: D32B 93P5

DIP INDETERMINATE

TRENCH BEARING 310

LENGTH 145

---

COAL ENCOUNTERED ALONG STRIKE BUT THICKNESS UNKNOWN

90 PERCENT OF TRENCH TILLED OUT

not drawn to scale