

Various pages, including Tables 5, 6, 7, and Appendices 2.2 through 2.8, contain confidential information or data, as described in Section 2 of the *Coal Act Regulation*, and have been excluded from this report.

*Coal Act Regulation*: [http://www.qp.gov.bc.ca/statreg/reg/C/251\\_2004.htm](http://www.qp.gov.bc.ca/statreg/reg/C/251_2004.htm)



# **WILLOW CREEK COAL PROJECT**

## **1996 COAL EXPLORATION PROGRAM**

**PINERIVER AREA  
LIARD MINING DIVISION  
NTS 93 O/9  
NAD27**

**Latitude: 55° 36' North  
Longitude: 122° 14' West**

**Owner :**

**Pine Valley Coal Ltd.**

**March 9, 1998**

**Submitted to :**

**The Ministry of Energy and Mines**

# TABLE OF CONTENTS

<b>SUMMARY</b>	<b>Page</b>
<b>1.0 INTRODUCTION .....</b>	<b>1</b>
1.1 Location and Access .....	.1
1.2 Topography and Vegetation .....	1
1.3 Property .....	2
1.4 History .....	.2
<b>2.0 1996 EXPLORATION PROGRAM .....</b>	<b>4</b>
2.1 Access .....	4
2.2 Control Survey .....	.4
2.3 Geological Mapping .....	5
2.4 Drilling Program .....	5
2.4.1 Winter Drilling .....	.5
2.4.2 Summer Drilling .....	.5
2.5 Borehole Geophysics .....	.6
<b>3.0 GEOLOGY .....</b>	<b>7</b>
3.1 Regional Geology .....	7
3.2 Property Stratigraphy .....	8
3.2.1 Cadomin Formation .....	8
3.2.2 Gething Formation .....	8
3.2.3 Bluesky Member .....	9
3.2.4 Moosebar Formation .....	9
3.2.5 Gates Formation .....	9
3.3 Coal Seam Development .....	.9
3.3.1 Seam 1 .....	10
3.3.2 Seam 2 .....	10
3.3.3 Seam 3 .....	10

3.3.4 Seam 4 .....	11
3.3.5 Seam A.....	11
3.3.6 Seam 5 .....	11
3.3.7 Seam 6 .....	11
3.3.8 Seam 7 .....	11
3.3.9 Seam 8 .....	12
3.4 Structural Geology .....	12
<b>4.0 COAL QUALITY .....</b>	<b>13</b>
4.1. Sampling Procedure .....	13
4.2. Sample Identification and Locations.. .....	13
4.3. Proximate Analyses .....	13
4.4. Sulphur Content.. .....	13
4.5. Ash Analyses .....	14
4.6. Free Swelling Index .....	14
4.7. Other Tests.....	14
<b>5.0 CONCLUSIONS .....</b>	<b>15</b>
<b>6.0 REFERENCES .....</b>	<b>16</b>
<b>7.0 EXPENDITURES .....</b>	<b>18</b>

## LIST OF FIGURES

- Figure 1: Location Map
- Figure 2: Coal Licenses
- Figure 3: Peace River Coal Fields
- Figure 4: Project Area Geology
- Figure 5: General Stratigraphy
- Figure 6a: 1996 Drillhole Location Map
- Figure 6b: Generalized Geology with Coal Seam Traces
- Figure 7a: Section 14000N
- Figure 7b: Section 15000N
- Figure 7c: Section 17000N

## LIST OF TABLES

- Table 1: Coal Licenses
- Table 2: Table of Formations
- Table 3: 1996 Exploration Summary
- Table 4: Raw Coal - Proximate Analysis
- Table 5: Clean Coal - Proximate Analysis
- Table 6: Mineral Analysis
- Table 7: Ash Fusion

## LIST OF APPENDICES

### APPENDIX 1 DRILLHOLES

- Appendix 1.1 Drillhole UTM Locations (NAD27)
- Appendix 1.2 Drillhole Summaries
- Appendix 1.3 Survey Control

### APPENDIX 2: ANALYTICAL RESULTS

- Appendix 2.1 Raw Coal Analyses
- Appendix 2.2. Clean Coal Analyses
- Appendix 2.3. Float Sink & Size Analysis
- Appendix 2.4. Mineral Analysis
- Appendix 2.5 Ultimate Analysis
- Appendix 2.6 Ash Fusion Temperatures
- Appendix 2.7 Miscellaneous
- Appendix 2.8 Petrography

### **APPENDIX 3. BOREHOLE GEOPHYSICAL LOGS.**

Volume 1 - WRH96001 - 050  
Volume 2 - WRH96050 - 115C  
Volume 3 - WRH963 15C - 180  
Volume 4 - WRH96180 - 243

## SUMMARY

The Willow Creek Coal Project coal licenses are located in the Peace River District of northeast British Columbia, approximately 45 kilometres west of the town of Chetwynd. As of 1996, the property included 33 coal licenses, encompassing 9,666 hectares of low, rounded ridges and hills typical of the foothills belt. The project consists of four separate groupings of coal licenses which are identified as Pine Pass (**Noman** Creek), Falling Creek, **Crassier**, and Willow Creek.

Access to the property area is excellent. B.C. Rail maintains a major transportation **corridor** directly alongside the property. Furthermore, Highway 97 (the John Hart Highway) and numerous secondary roads and trails provide direct access to, and within, the property.

The Willow Creek area has been the subject of numerous coal-exploration studies since the 1970's when the Japanese steel industry showed an interest in British Columbia coking coals. In 1980 / **81**, Semper Resources / David Minerals Ltd. completed 42 trenches and 46 diamond drillholes, totaling 12,094 metres. This work identified a total resource-potential, down to 500 metres, of 73 million raw-coal tonnes. Subsequent to completion of the exploration study, Kilborn Engineering Ltd. completed an underground mine-feasibility study to produce about 600,000 tonnes product coal, destined for thermal coal markets.

Globaltex Industries Ltd. (Globaltex) acquired the Willow Creek coal licenses in the early 1990's and proceeded with a review of all previous information. The review identified the potential for coking-coal reserves in what was previously marketed as thermal coal. A two phased drilling program was completed which comprised a 108 holes totaling **about 4,000** metres. Four bulk drill core samples were taken for detailed coal characterization studies. Subsequent laboratory results confirmed the presence of medium-volatile coking coals in Seams **1, 2, 3, 4** and A, and low-volatile bituminous coals were identified in Seams **5, 6, 7,** and 8.

In early 1996, a joint venture was initiated between Falls Mountain Coal Inc., BCR Ventures Ltd., and Miisui Matsushima Canada Ltd. to further explore and develop the property. Pine Valley Coal Ltd. was created in 1996 to represent the collective interests of the participants and to act as operator.

In January of 1996, Pine Valley Coal Ltd. commenced a two-phase exploration program on the Willow Creek Property. The **first** phase, canted out from January to April 1996, acquired geological information from air rotary drilling with some spot core sampling of selected seams for coal quality data. The second phase, conducted during June to October 1996, continued with the air rotary program and spot coring, and added some geological mapping in the Willow East and the Willow West areas. The purpose of the program was to further delineate the southern extension of the upper medium volatile and lower low volatile bituminous coals in the Central and South Blocks of Willow East. In total, 235 holes were drilled totaling about 9500 metres.

The 1996 Exploration Program was successful in extending the known coal measures to Willow South and Willow West.

## 1.0 INTRODUCTION

Commencing January 26, 1996, Pine Valley Coal Ltd., acting as operator for the joint venture partners of Falls Mountain Coal Inc., BCR Ventures Ltd. and Mitsui Matsushima Canada Ltd., conducted a coal exploration program on the Willow Creek coal licenses. The program, divided into a winter phase (carried out until March break-up) and a summer phase (conducted after break-up and terminated in October 1996), consisted of air rotary and core drilling as well as some geological mapping. It was primarily designed to delineate the southern extension (Willow East, Central, and South blocks) of the middle Gething coal seams (Seams 5, 6, 7 and 8) and upper Gething coal seams (Seams 1, 2, 3 and 4), as well as provide core samples for coal characterization studies.

Over the course of the program, 175 air rotary and 60 core drill holes were completed for a total of 9390 metres of drilling. As well, 60 seam sections were cored and sent to Loring Laboratories Ltd. in Calgary, Alberta for coal quality analyses.

### 1.1 Location and Access

The Willow Creek Coal property is located in the Peace River District of Northeast British Columbia. The coal licenses which comprise the property are positioned adjacent to the Pine River, approximately 50 km west of the town of Chetwynd. The properties are situated on NTS map 930/9 and are centered on the approximate coordinates of 55° 36' North latitude, 122° 14' West longitude. Figure 1 illustrates the property location within the Province of British Columbia and Figure 3 shows its relative location with other known coal deposits in the Peace River Coal Field region. The property has been informally separated into the Willow East and Willow West zones using the Willow Creek drainage as a dividing line. Willow East has been further subdivided into the North, Central, and South Blocks.

The primary road access to the project area is via the John Hart Highway (Highway 97); an all weather highway which connects the Peace River District with the central interior city of Prince George, B.C. Ground access is provided by secondary and tertiary roads which branch off from Highway 97. Logging in the early 90's created an efficient network of forestry roads which facilitates the ground transportation to and from the property.

B.C. Rail operates a rail line through the Pine River valley to service the Peace River District. The rail provides direct access to the port of Vancouver, B.C. or indirect access via Canadian National Railway at Prince George, to the Ridley Island Coal Port at Prince Rupert, B.C.

The Peace River District is serviced by daily commercial airline flights to the cities of Dawson Creek & Fort St. John. These services have respective road distances to the Willow Creek properties of roughly 150 and 210 km's.

### 1.2 Topography and Vegetation

The Willow Creek coal licenses cover the eastern foothills of the Rocky Mountains. The area is characterized by relatively low, rounded, northwest-southwest trending ridges and valleys





**WILLOW CREEK PROJECT**

**ALBERTA**

**BRITISH COLUMBIA**

**PACIFIC OCEAN**

**LEGEND**  
— Roads  
—+— Railway

100 km 0 100 200 300 400 km  
Scale

 **PINE VALLEY COAL LTD.**  
**WILLOW CREEK PROJECT**  
**LOCATION MAP**  
**FIG. 1**

dissected by the northeast 1.5 km wide Pine River valley. Elevations range from 625m in the valley bottom to **1400m** along the upper ridges.

The vegetation is typical of an open forest with limited undergrowth, covered by jackpines & minor spruce. Willows and stands of poplars are common in the low lying areas.

### 1.3 Coal Licenses

In 1996, Pine Valley Coal Ltd. held tenure on thirty-three (33) coal licenses collectively referred to as the Willow Creek Coal Property. The coal licenses cover approximately 9666 hectares and are located in the Peace River Land District of northeastern British Columbia. Figure 2 illustrates the general layout of the licenses, and Table 1 provides summary description.

### 1.4 History

Coal was discovered in the Peace River District of British Columbia during Alexander MacKenzie's overland journey to the Pacific some 200 years ago. The first coal licenses were granted in 1908, but owing to the remoteness of the area, it was not until the 1940's that the coals were exploited. Construction of the Alaska Highway probably triggered the development of 3 small mines near the present day W.A.C. Bennett hydroelectric dam. The coal seams were located in the Gething Formation- named after the principal operator of the mines, the Gething family. These coal mines had a rather brief history, as major gas and oil fields discovered in the northeast replaced coal in the market.

From 1946 to 1951, the Coal Division of the B.C. Department of Lands and Forests conducted coal exploration in the Pine River Area of the Peace River District in anticipation of the construction of another major rail route through the Rockies. The work concentrated on three areas: Willow Creek, **Noman** Creek (now referred to as Pine Pass Coal Licenses), and Hasler Creek. Based upon geological mapping, trenching, and 81 diamond drillholes totaling 14,829 metres, the government program estimated the respective tonnage potential of the three areas at 20.9 million tonnes, 8.2 million tonnes, and 7.3 million tonnes. The reserve estimates were based on reserves at a thickness cut-off of 1.2 meters.

As a result of the work completed by the British Columbia Department of Lands and Forests in the 1940's and **50's**, which included trenching and 39 diamond drillholes totaling approximately 7,147 metres, the Willow Creek area has been the subject of various exploration programs in the 1970 and the 80's. In 1973, the Pine Pass Coal Company drilled over 500 metres in 5 diamond holes at the headwaters of Willow and Johnson creeks. Although the drilling confirmed the presence of the thick coal seams in the Gething Formation at this locale, the perceived structural and stratigraphic problems precluded further drilling in the area. In addition to the Pine Pass Coal Company, the only company to drill test the Gething Formation in the Willow Creek area was Semper Resources / David Minerals in 1980 and 1981. Crows Nest Resources Ltd. (Shell Canada Resources), Pan Ocean Oils Ltd. and Norcen Energy Resources Ltd. all looked at the area in the **70's** and **80's**, but only reconnaissance style geological mapping was completed.

**Table 1****Coal Licenses**

<b>Coal License No.</b>	<b>Land District</b>	<b>PNG Description</b>		
		<b>Map Reference</b>	<b>Block</b>	<b>Units</b>
327289	Peace River	930/9	F	41,42,51,52
327290	Peace River	930/9	G	49,50,59,60
327291	Peace River	930/9	G	29,30,39,40
327292	Peace River	930/9	G	25,26,35,36
327293	Peace River	930/9	G	27,28,37,38
327294	Peace River	930/9	G	47,48,57,58
327296	Peace River	930/9	F	1,2,11,12
327297	Peace River	930/9	F	21,22,31,32
327298	Peace River	930/9	F	61,62,71,72
327299	Peace River	930/9	G	5,6,15,16
327300	Peace River	930/9	G	19,10,19,20
327301	Peace River	930/9	G	7,8,17,18
327302	Peace River	930/9	G	3,4,13,14
327303	Peace River	930/9	B	85,86,95,96
327304	Peace River	930/9	B	85,86,95,96
327307	Peace River	930/9	B	81,82,91,92
327308	Peace River	930/9	B	63,64,73,74
327310	Peace River	930/9	B	61,62,71,72
327312	Peace River	930/9	F	27,28,37,38
327313	Peace River	930/9	F	29,30,39,40
327314	Peace River	930/9	B	49,50,59,60
327316	Peace River	930/9	C	63,64,73,74
327318	Peace River	930/9	C	83,84,93,94
327320	Peace River	930/9	C	41,42,51,52
327321	Peace River	930/9	C	61,62,71,72
346175	Peace River	930/9	F	83,84,93,94
346176	Peace River	930/9	F	63,64,73,74
346177	Peace River	930/9	B	87,88,97,98
347214	Peace River	930/9	L	1,2,11,12
347215	Peace River	930/9	B	29,30,39,40
347216	Peace River	930/9	B	27,28,37,38
347217	Peace River	930/9	B	7,8,17,18
347216	Peace River	930/9	B	5,6,15,16

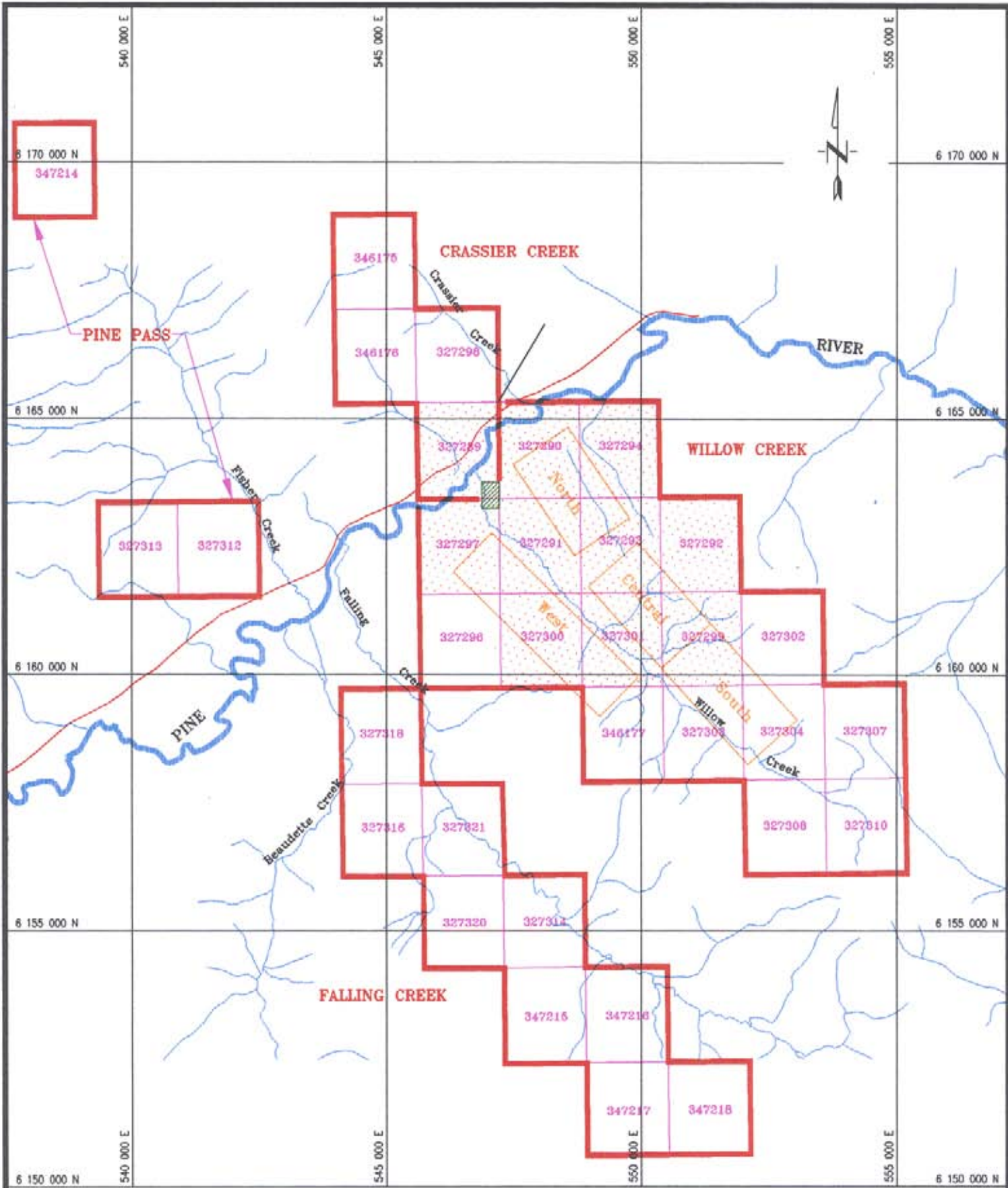

**LEGEND**

- 347216 COAL LICENSES
- PLANT SITE AREA LICENSE OF OCCUPATION
- CONVERT COAL LICENSES TO COAL LEASE
- North RESERVE AREAS

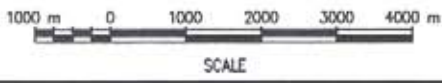



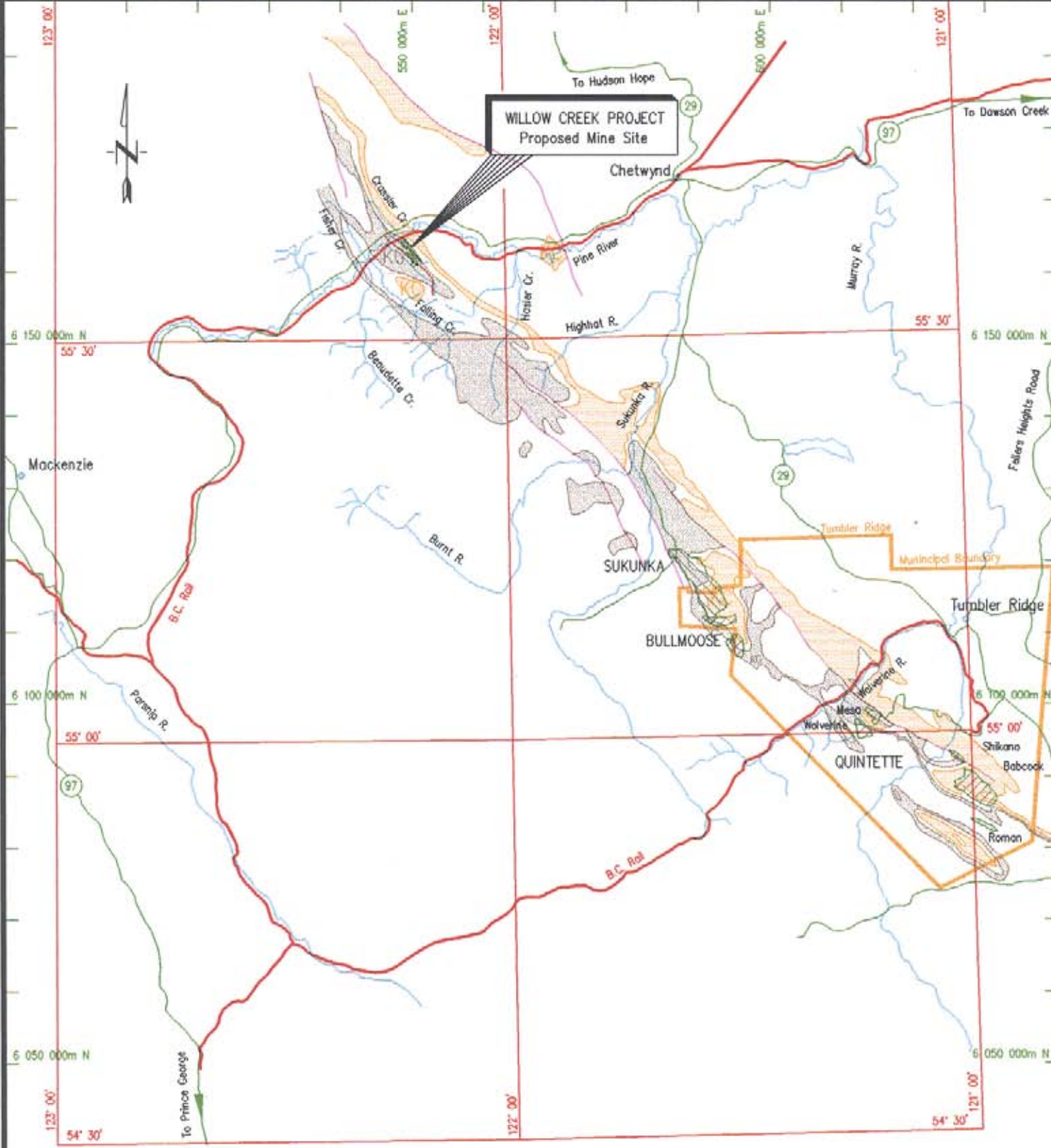

**PINE VALLEY COAL LTD.**  
WILLOW CREEK PROJECT  
COAL LICENSES

FIG. 2





**LEGEND**

-  Roads
-  Railway
-  Watercourse
-  Coal Deposit
-  Pine Valley Coal Licenses
-  KC (Gates, Hulcross, Boulder Creek Formation combined)
-  KG (Gething Formation)

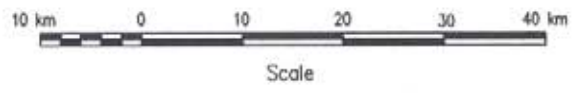

 **PINE VALLEY COAL LTD.**  
**WILLOW CREEK PROJECT**  
**PEACE RIVER COAL FIELDS**  
 DATE : AUG 31, 1997. **FIG. 3**

This page contains confidential information or data, as described in Section 2 of the *Coal Act Regulation*, and has been excluded from this report.

*Coal Act Regulation:* [http://www.qp.gov.bc.ca/statreg/reg/C/251\\_2004.htm](http://www.qp.gov.bc.ca/statreg/reg/C/251_2004.htm)

## 2.0 1996 EXPLORATION PROGRAM

In January of 1996, Pine Valley Coal Ltd. commenced a two-phase exploration program on the Willow Creek Property. The project was conducted over Coal Licenses 327290 - 294 and 327299 - 304 of Willow East and 327296 - 327297 of Willow West. The first phase, carried out from January to April 1996, was intended to acquire geological information from air rotary drilling with some spot core sampling of selected seams for coal quality data. The second phase, conducted during June to October 1996, continued with the air rotary program and spot coring, adding some geological mapping in the Willow East and the Willow West areas. The purpose of the program was to further delineate the southern extension of the upper medium volatile and lower low volatile bituminous coals in the Central and South Blocks of Willow East, as well as, to determine the westward extension of the economic coal seams. Table 2 summarizes the two work programs and Figure 99 illustrates the locations of the combined drill programs.

**Table 3**  
**1996 Exploration Summary**

	<u>Winter</u>	<u>Summer</u>
<u>Access Trails</u>		
New drill trails	5.2 km	1.9 km
<u>Air Rotary Holes</u>		
# of Holes	40	135
Total Length (m)	3325.5 m	5463.5 m
<u>Core Holes</u>		
# of Holes	5	55
Total Length cored (m)	53.5 m	547 m
<u>All Holes</u>		
# of Holes	45	190
Total Length (m)	3379 m	6010.5 m

### 2.1 Access

A series of forestry roads were constructed in the early 1990's, when clear-cut logging took place in the area. These roads provide the main access from Highway 97 into the exploration area. Ken Murfitt Contracting from Chetwynd, B.C. was hired to repair and construct drill trails, prepare drill sites and provide on-site support for drill moves. A TD20C, equivalent to a D6/7 dozer, was used for a majority of the work. The total length of drill trail (including drill sites) constructed during 1996, was approximately 7.1 kilometres.

### 2.2 Control Survey

The original control survey, conducted by McElhanney & Associates in 1981, was located

and used as the survey control grid for the 1996 exploration program. During the winter phase of the program, McElhanney again tied into their original survey, as well as additional 1994 control points, to establish the locations of the 1996 drill holes. Appendix 1.3 contains the control established by McElhanney in 1996. Also, McElhanney established a control survey for the South and Central Blocks. During the summer phase of the 1996 program, Canyon Contracting of Hudson Hope, B.C., tied into **McElhanney's** survey to locate the holes drilled during the summer.

## 2.3 Geological Mapping

A limited geological mapping program over the Willow East (North, Central and South Blocks) and Willow West areas, was conducted during the summer phase of the 1996 exploration program. The intent was to tie in surface exposures of coal seams and other strata with drill hole information to enhance structural and stratigraphic control of the property.

## 2.4 Drilling Program

### 2.4.1 Winter Phase

During the first phase (winter) of the 1996 exploration program, drilling was contracted to both Tercon Construction Ltd. (Kamloops, B.C.) and Nielsen Drilling Enterprises Ltd. (Hinton, Alta.). Drilling commenced March 2, and was terminated March 29, 1996. Tercon conducted only open-hole air drilling with a track-mounted, **D25K** blast hole rig. Nielsen, who conducted some air rotary drilling and all of the coring, used a wheel-mounted SCHRAMM air-rotary, waterwell rig converted for exploration drilling. The open hole drill diameter was generally 165 mm. **Wireline** coring was carried out using a Christenson **75mm** core barrel and a specialized diamond/carbide bit. A total of 45 open holes were completed during the winter phase, totaling 3379 metres drilled. Selected intervals from 5 of those holes were cored, totaling 53.5 metres of coring. Table 3 provides a brief summary of the 1996 winter drilling. A more complete summary can be found in Appendix 1.2.

### 2.4.2 Summer Phase

The summer phase of the drilling began on July 13 and terminated on September 29, 1996. Drilling was contracted out to Alberta Southern of Calgary, Alta. and McCaws of Rocky Mountain House, Alta. Alberta Southern conducted both open-hole and **wireline** coring utilizing a TH60 waterwell drill rig converted for exploration. McCaws conducted only **open-hole** drilling utilizing a GD tank drill. Alberta Southern's open-holes were generally 165 mm in diameter and core samples 75 mm in diameter. McCaws open-holes were approximately 75 mm in diameter. In all, 190 drillholes were completed totaling 5463.5 metres of **open-hole** drilling and 547 metres of coring during the summer. Drilling depths ranged from as little as 3 metres to as much as 118 metres. It should be noted that a few holes were drilled twice because of unstable conditions. Table 2 provides a brief summary of the summer drilling. Appendix 1.3 provides a more complete summary.



## 2.5 Borehole Geophysics

Throughout the 1996 exploration program, **borehole** geophysical logging was provided by Century **Geophysical** Ltd. of Calgary, Alberta. In most of the drillholes, when stable hole conditions prevailed, the following suite of geophysical logs were obtained:

- Gamma Ray
- Neutron
- Density
- Resistivity**
- Caliper
- Directional Survey

If poor hole conditions were present, a gamma-neutron log was obtained through the rods, if possible. Copies of all completed 1996 **borehole** geophysical logs are contained in Appendix 3.

## 3.0 GEOLOGY

### 3.1 Regional Geology

The Willow Creek project area lies within the northwesterly trending Rocky Mountain Foothills belt of northeastern British Columbia. The region is predominantly underlain by Lower Cretaceous sediments of the Bullhead and Fort St. Groups which were deposited in a succession of transgressive and regressive cycles along the western edge of the Western Canada Basin (Figure 2). These cycles gave rise to depositional environments which ranged from marine to near shore to deltaic and alluvial. In turn, lithologies such as mudstone, siltstone, coal, fine to coarse sandstones and conglomerates were produced. Nomenclature and classification of these Lower Cretaceous units are presented on Table 3 and have been adopted from D.F. **Stott** (G.S.C. Bulletin 328) of the Geological Survey of Canada.

The oldest unit in the project area is the Cadomin Formation (Bullhead Group) which is composed of coarse alluvial grits and minor lenses of conglomerate containing **chert** and quartz pebbles. This unit conformably underlies the Gething Formation (Bullhead Group) which is the principal unit of economic importance in the area. The Gething Formation is composed of medium to coarse alluvial sandstones and siltstones with intermittent coal seams at its base and grades upward through a zone in the middle Gething of transgressive marine mudstones and siltstones. The Upper-Middle to Upper Gething contains a regressive sequence of near shore to deltaic plain environments composed of **marine** to non-marine mudstones, siltstones and fine sandstones. Of primary significance are nine economic coal seams, Seams 1 through 8 and Seam A, hosted within the Upper Gething. Their coal seam zones, including rock partings and coal splits vary in stratigraphic thickness from 0.5 to over **15** metres, and range in rank from medium volatile bituminous to low volatile bituminous coals.

Overlying the Gething is a glauconite, pebbly marker unit referred to as the **Bluesky** Member. The **Bluesky** Member of the **Moosebar** Formation represents the basal unit of the Fort St. John Group and is considered to be a lag deposit formed during the initial transgression of the **Moosebar** Sea (Legun, 1983). The remainder of the **Moosebar** grades vertically through marine shales to the marine and nonmarine sandstones, siltstones and coal of the Gates Formation. The Gates is in turn overlain by the Hulcross, Boulder Creek, **Hasler**, Goodrich and Cruiser Formations which comprise the remainder of the Fort St. John Group.

The Pine Valley area lies within the Rocky Mountain Thrust Belt. The structural framework in this area is dominated by two large northwest trending folds known as the Pine River Anticline and the Fisher Creek Syncline. These two structures and their subsidiary disharmonic folds undulate along their axes plunging gently to the southeast. Large fold limbs generally dip northeast and southwest at angles of 30" to 35". As well, occasional small easterly dipping faults, related to steep parasitic folds along the limbs of the major structures, appear to cut the area.

## 3.2 Property Stratigraphy

### 3.2.1 Cadomin Formation (Bullhead Group)

As noted in Section 3.1 the Cadomin Formation of the Bullhead Group is most likely the oldest formation exposed on the Willow Creek Property (Figure 4, Project Area Geology). This unit has been observed in West Coast Energy's quarry on the Willow Creek Forest Services Road, which positions it in the core of the Pine Valley Anticline. It consists of massive coarse sandstone grits with thin pebble to small cobble (3 - 4 cm) lenses. Although the Cadomin is generally identified by massive conglomerates with well-rounded cobbles and boulders, this unit correlates well with both Hughes' (1964) and **Stott's** description of the Cadomin as it extends north into the Pine and Peace River valleys.

On the Willow Creek Property, the formation is of undetermined thickness with highly resistant exposures widely distributed throughout the property.

### 3.2.2 Gething Formation (Bullhead Group)

The Gething Formation, also of the Bullhead Group, conformably overlies the Cadomin Formation and underlies the **Bluesky** Member of the **Moosebar** Formation. It primarily consists of multiple fining upward cyclothems which suggest a **fluvial** to deltaic environment, although some evidence of a near shore, marine transgressive sequence appears to exist near the top of the Middle Gething.

The Gething Formation is distinguished from the coal bearing **Bickford** Formation, which underlies the Cadomin Formation, by its greater proportion of shale and **numerous** coal seams, and also by its greater proportion of plant fossils. It includes dark grey mudstone; siltstone; **lithic**, very-fine to coarse-grained sandstone; carbonaceous, silty and sandy mudstone; coalified plant debris; minor bentonite; black shale; occasional minor **tuffs** in the upper part; minor conglomerate; and coal. Below the **Bluesky** Member (Moosebar Formation), the Gething contact is characterized by a carbonaceous to coal zone termed by company geologists, the Bird Zone. This zone grades from carbonaceous shales in the north to a 2 metre coal seam in the south. The rest of the Gething is comprised of distinctive, interbanded, dark grey **mudstone** and lighter grey siltstone, as well as, fine **grained** sandstones with occasional pebble bands and coal stringers. The formation is approximately 500 metres thick on the Willow Creek Property.

Coal seams have been drilled and trenched throughout of the much of the Willow Creek Property. The economic seams to date (Seams **1 - 8** and A), occur in the Upper and Middle Gething, although some seams have been located in Lower Gething. Coal quality data, as well as geophysical signatures, indicate a probable correlation between the Willow Creek Seams 1 - 4 and Gibson's (1992) description of the Upper Gething Chamberlain Member in the Burnt River-Sukunka region. Below Seam 4, A Seam appears to occur within a near shore transgressive environment which is loosely equivalent to the Bullmoose Member ('marine tongue') found southeast of the property. The lower seams found on the Willow Creek **Property (Seams 5 - 8)** may then correlate with the Gibson's **Gaylard** Member of the Gething Formation. Seams vary in thickness from 0.5 m to 7.0 metres.

### 3.2.4 **Bluesky** Member (Fort St. John Group)

The **Bluesky** Member of the **Moosebar** Formation characterizes the basal unit of the **Fort St. John** Group in northeast British Columbia. The member consists of fine to medium-grained sandstone, **mudstone** and thin conglomerate beds having well-rounded **quartzite** pebbles. The unit is glauconitic, and according to Legun (1983), it represents a lag deposit formed during the initial transgression of the **Moosebar** Sea. In the Willow Creek area, the **Bluesky** Member ranges from 0.5 m to 40 metres thick.

### 3.2.5 **Moosebar** Formation (**Fort St. John** Group)

The **Moosebar** Formation comprises a thick, marine transgressive sequence of **dark to medium grey mudstone** and shales, grading upward to dark grey siltstone. Glauconitic shale beds occur near the base of the formation and its contact with the **Bluesky** Member.

The upper beds of the **Moosebar** are gradational and it is overlain by the Gates Formation. The boundary of the Gates and the **Moosebar** Formations is characterized by a thick succession of sandstone. The **Moosebar** is approximately 280 metres thick in the Willow Creek area.

### 3.2.4 **Gates** Formation (**Fort St. John** Group)

In the property area, the Gates Formation is characterized by a fine to medium-grained, prominent sandstone at its base. The formation grades upward to a succession of **well-sorted** sandstones interbedded with carbonaceous shale, siltstones, thin coal seams and minor conglomerate (Stott, 1982). The coarse sandstones and conglomerates often coarsen upward indicating a prograding delta (Karst, 1980). The Gates varies in thickness from about 80 m to 200 m.

## 3.3 **Coal Seam Description**

The specific seams of economic interest on the Willow Creek Property to date are Seam 1 through Seam 8 and A Seam. As indicated in Section 3.2.2, these seams all lie within the Middle to Upper Gething. Another seam, referred to as Seam 9, lies below Seam 8, and has shown **mineable** thickness on the property but is not currently of economic interest. As well, immediately below the upper contact of the Gething Formation with the **Bluesky** Member lies the Bird Zone. This thin sequence is characterized by a carbonaceous to **coaly** zone in the north part of the property which grades to a 2 m thick, relatively clean coal seam as it extends toward the central and south part of the property. Although coal quality data has yet to be obtained from the Bird Zone, according to **McKechnie (1955)**, the Bird Zone coal appears to have a higher sulphur **content** than do the other coal seams in the Gething. Figure 5 illustrates the general stratigraphic position of the main coal seams within the Willow Creek property.

Over the extent of the Willow Creek Property, some of the coal seams split from one location to another. This is evident, for example, in Seam 1 where the seam has three distinct coal splits in the North Block which appear to combine into a single seam in the Central and South Blocks. In order to distinguish and correlate each seam and its

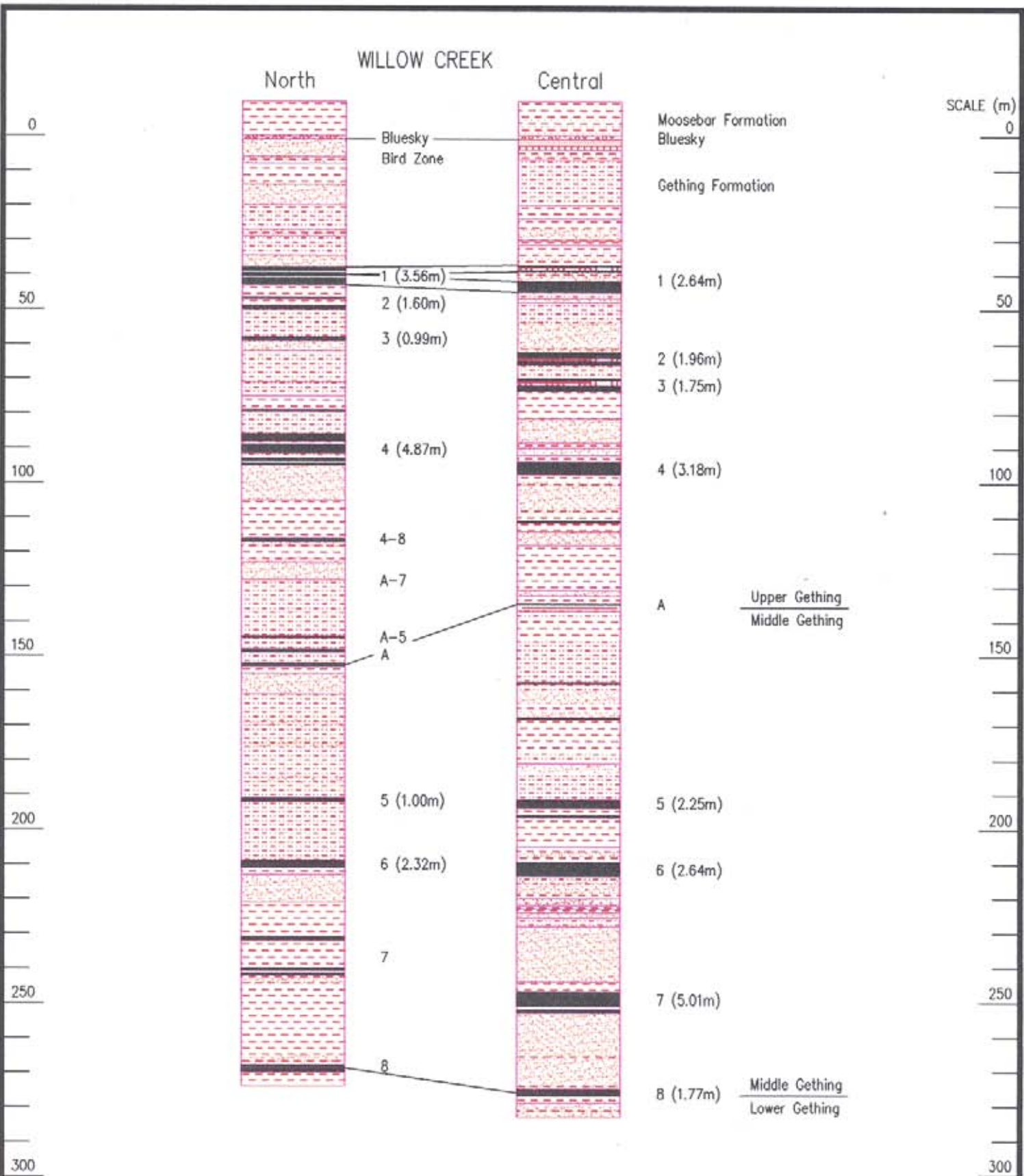

attendant variations throughout the property, Pine Valley Coal Ltd. has developed a nomenclature that allows each coal split to be uniquely identified.

The formula for this descriptive system primarily involved a property-wide identification of the main coal segment of any given seam. This unit for each seam was termed the "zero unit". For example, as with Seam 1, the main coal unit is referred to as 1-0. Any coal partings or "rider seams" that **split** away from and above the main seam are designated with odd numbers in succeeding order. As in the North Block with Seam 1, the **first** split above Seam 1-0 is referred to as I-1 and the coal split above that as I-3. Also, this designation procedure is utilized with respect to any coal units that develop from the **splits** themselves. Therefore, if unit I-1 developed a rider itself which split above it then that new rider would be called I-1.1, and so on.

Similarly, for coal splits that develop below the main seam, a designation of even numbers is assigned for each successive coal unit. For example, the first coal split below the main Seam 7 is referred to as 7-2 and that split in turn developed a small rider above it which was assigned the name 7-2.1. This naming procedure allows the company's geologist to **identify** and correlate any unit that is encountered during exploration.

### 3.3.1 Seam 1

Composed primarily of medium volatile bituminous coals, this seam is located at the top of the economic Gething coal sequence approximately 30 - 50 **metres** below the Gething and **Moosebar** contact. Seam 1 can include up to three splits, respectively termed I-3 (**0.55m**), I-1 (**0.85m**) and 1-0 (**2.40m**) with an average rock parting thickness of about 1.45 m. These three coal units, evident in the North Block, tend to draw together and combine into a single seam at about Line 15800 (a description of the grid system can be found in Section 2.0, 1996 Exploration Program). Thickness, including upper splits and rock partings, range from approximately 8.30 metres in the North Block to 2.30 metres in the Central Block.

### 3.3.2 Seam 2

Seam 2 lies about 15 m below Seam 1. Also a medium volatile coal, Seam 2 is composed of coal splits 2-0 (**1.3m**) and 2-2 (**1.05m**) with an average rock parting thickness of about 1.10 m. The coal units combine into a single seam toward the central part of the property. The seam can at times be identified by an overlying bentonitic clay unit or a sequence of thick, coarse channel deposits which overlie if between Line 15600 to L 14800. Seam 2 coal zones range from 7 m to 1.52 m in thickness.

### 3.3.3 Seam 3

Seam 3 generally consists of a single coal seam, without splits and is located approximately 15 m below the base of Seam 2. Thickness can range from 3.49 m to 0.2 m with an average true thickness of about 1.48 m. Seam 3 appears to thicken towards the south.

### 3.3.4 Seam 4

Seam 4 situated about 40 metres below the bottom of Seam 3, is also medium **volatile** coal and contains numerous splits and partings over the property length. The thickest zone for Seam 4 lies around Line 16200. Average coal zone thickness is **approximately 9.00 m** which includes coal units **4-1.1 (0.95m)**, **4-1 (1.10m)**, **4-O (2.75m)**, and **4-2 (0.95m)**. Rock splits average about **3.25m** combined. Seam 4 coal zone can vary over the property from about 15.55 m to 3.15 m in thickness and can be readily identified on geophysical logs by a sandstone unit that lies at the base of the seam.

### 3.3.5 Seam A

Seam A is located approximately 45 metres below Seam 4 and although identified as a medium volatile coal, it divides the lower (Seams 5 - 8) low volatile Willow Creek coals from the upper (Seams 1 - 4) medium volatile coals. An average coal zone for Seam A is characterized by coal **units A-3 (0.55m)**, **A-1 (0.95m)**, **A-O.1 (0.35m)**, **A-O (1.20m)** and **A-2 (0.45m)**. Rock partings average approximately 2.35 metres in combined thickness.

### 3.3.6 Seam 5

This seam is situated about 65 metres below Seam A. It includes three coal splits, referred to as **5-0**, **5-2** and **5-8** with average respective thickness of **1.25 m**, **0.75m** and **0.65m**. The rock parting between **5-0** and **5-2** averages about **0.85m** in thickness. The **5-8** coal unit sits well below the rest of Seam 5 and may be considered a separate seam.

### 3.3.7 Seam 6

Seam 6 located about 20 metres below the base of Seam 5, is another seam that has developed numerous coal splits both above and below the main coal seam. However, only **6-O (2.40m)** and **6-0.2 (0.55m)** are considered for mining at this time. The rock parting that divides these two coal units averages approximately 0.45 metres in thickness. Seam 6, as with Seam 5, is graded as a low volatile bituminous coal.

### 3.3.6 Seam 7

Seam 7 has the thickest coal development on the property and includes a number of coal splits that can be mined collectively. It lies **approximately 35 - 40 metres** below Seam 6 and is comprised of coal units **7-0.1 (2.60m)**, **7-O (0.95m)**, **7-2.1 (0.40m)**, and **7-2 (1.25m)**. Rock partings average about 2.05 metres in combined thickness. Seam 7 can be identified, both in the field and on geophysical logs, not only its thick coal signature, but also by the medium to coarse sandstones which surround it. The coal is classified as low volatile bituminous coal.

### 3.3.9 Seam 8

This seam defines the base of the coal seams considered to be of economic value on the Willow Creek Property, at this time. It is generally comprised of a single coal unit (8-O) which has an average thickness of about 1.60 metres. Seam thickness can vary from 2.35 metres to 0.8 metres.

## 3.4 Structural Geology

The structural fabric of the Lower **Cretaceous** Gething in the Willow Creek area appears to be fold dominated rather than fault dominated. As discussed in Section 3.1 (Regional Geology), the Pine Valley is structurally characterized by two major northwest trending, southeast plunging folds referred to as the Fisher Creek **Syncline** and the Pine Valley Anticline. The Willow Creek Property lies along the axis of the Pine Valley Anticline. To date, most of the geology work and thus the structural definition on the property, has been carried out in the Willow East area (North, Central and South Blocks) which lies along the eastern limb of the Pine Valley Anticline. This fold limb generally dips gently at 30° to 35° to the northeast. But, in the Willow Creek area, the eastern limb of the Pine Valley Anticline is also characterized by a sequence of subsidiary (parasitic?) folds referred to as the Willow Structure and the Spruce Structure. These secondary structures, which expose the coal measures in the Gething, tend to be disharmonic in nature and are comprised of an **anticline/syncline** system each. Trending sub-parallel to the Pine Valley axis, they are composed of a series of doubly plunging folds which range from broad concentric in the north to almost isoclinal and overturned as they extend south.

The disharmonic character of both of these structures may be a function of the lithologies, such as shale, siltstone and coal, present in the Gething and **Moosebar** sequence. Both of these formations make up most of the strata present on the Willow Creek Property. Since the Gething and **Moosebar** Formations, which are composed of less competent sediments, are sandwiched between the well indurated sandstones and conglomerates of the overlying Gates and underlying Cadomin Formations, they will tend to absorb the space problems inherent in large-scale fold structures (i.e. the Pine Valley Anticline and Fisher Creek Syncline). This can lead to the disharmonic folding with attendant chevron and overturned isoclinal structures found on the property.

The Willow Anticline is located northeast of the Spruce structure and is generally characterized by a range of broader concentric folding to a tighter, almost overturned structure. The limbs dip gently at 30° to 35° on the northeast and can be subvertical on the southwest side. The crest of the Willow Anticline is also complicated by smaller folds. The adjacent Willow **Syncline** conversely has a steep northeast limb and a gentler southwest limb. The Spruce Structure lies immediately southwest of the Willow Structure and tends to be composed of a smaller, tighter fold system. It generally parallels the Willow system.

Figure 4, Figure 6b, and Figures 7a-c, illustrate the structural configuration of the property.



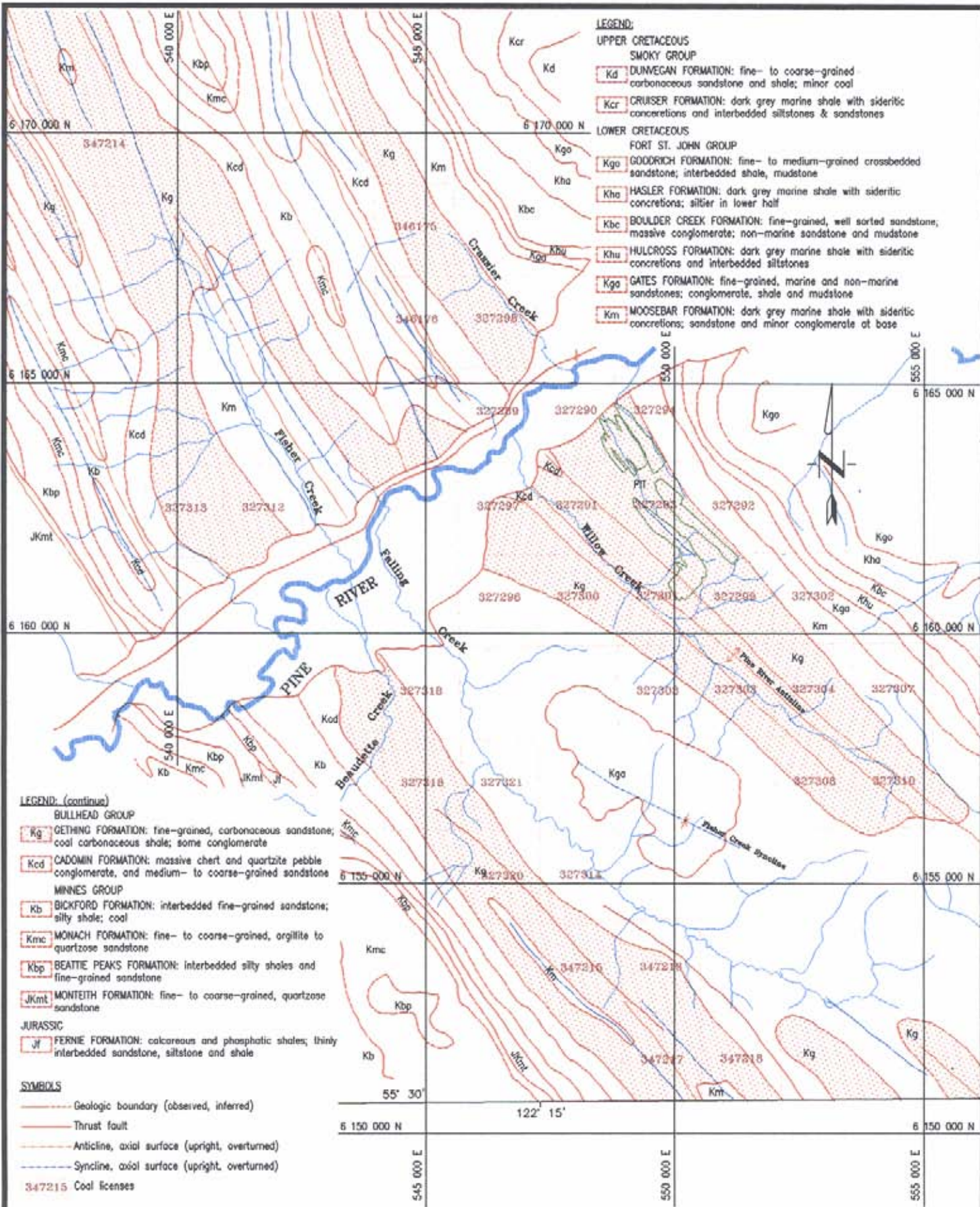

**LEGEND:**

**UPPER CRETACEOUS**  
**SMOKY GROUP**  
**Kd** DUNVEGAN FORMATION: fine- to coarse-grained carbonaceous sandstone and shale; minor coal  
**Kcr** CRUISER FORMATION: dark grey marine shale with sideritic concretions and interbedded siltstones & sandstones

**LOWER CRETACEOUS**  
**FORT ST. JOHN GROUP**  
**Kgo** GODDRICH FORMATION: fine- to medium-grained crossbedded sandstone; interbedded shale, mudstone  
**Kha** HASLER FORMATION: dark grey marine shale with sideritic concretions; siltier in lower half  
**Kbc** BOULDER CREEK FORMATION: fine-grained, well sorted sandstone; massive conglomerate; non-marine sandstone and mudstone  
**Khu** HULCROSS FORMATION: dark grey marine shale with sideritic concretions and interbedded siltstones  
**Kga** GATES FORMATION: fine-grained, marine and non-marine sandstones; conglomerate, shale and mudstone  
**Km** MOOSEBAR FORMATION: dark grey marine shale with sideritic concretions; sandstone and minor conglomerate at base

**LEGEND: (continue)**

**BULLHEAD GROUP**  
**Kg** GETHING FORMATION: fine-grained, carbonaceous sandstone; coal carbonaceous shale; some conglomerate  
**Kcd** CADOMIN FORMATION: massive chert and quartzite pebble conglomerate, and medium- to coarse-grained sandstone

**MINNES GROUP**  
**Kb** BICKFORD FORMATION: interbedded fine-grained sandstone; silty shale; coal  
**Kmc** MONACH FORMATION: fine- to coarse-grained, argillite to quartzose sandstone  
**Kbp** BEATTIE PEAKS FORMATION: interbedded silty shales and fine-grained sandstone  
**JKmt** MONTEITH FORMATION: fine- to coarse-grained, quartzose sandstone

**JURASSIC**  
**Jf** FERNIE FORMATION: calcareous and phosphatic shales; thinly interbedded sandstone, siltstone and shale

**SYMBOLS**

- Geologic boundary (observed, inferred)
- Thrust fault
- Anticline, axial surface (upright, overturned)
- Syncline, axial surface (upright, overturned)
- 347215 Coal licenses

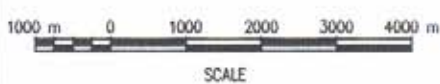

**PINE VALLEY COAL LTD.**  
**WILLOW CREEK PROJECT**  
**PROJECT AREA GEOLOGY**  
**FIG. 4**



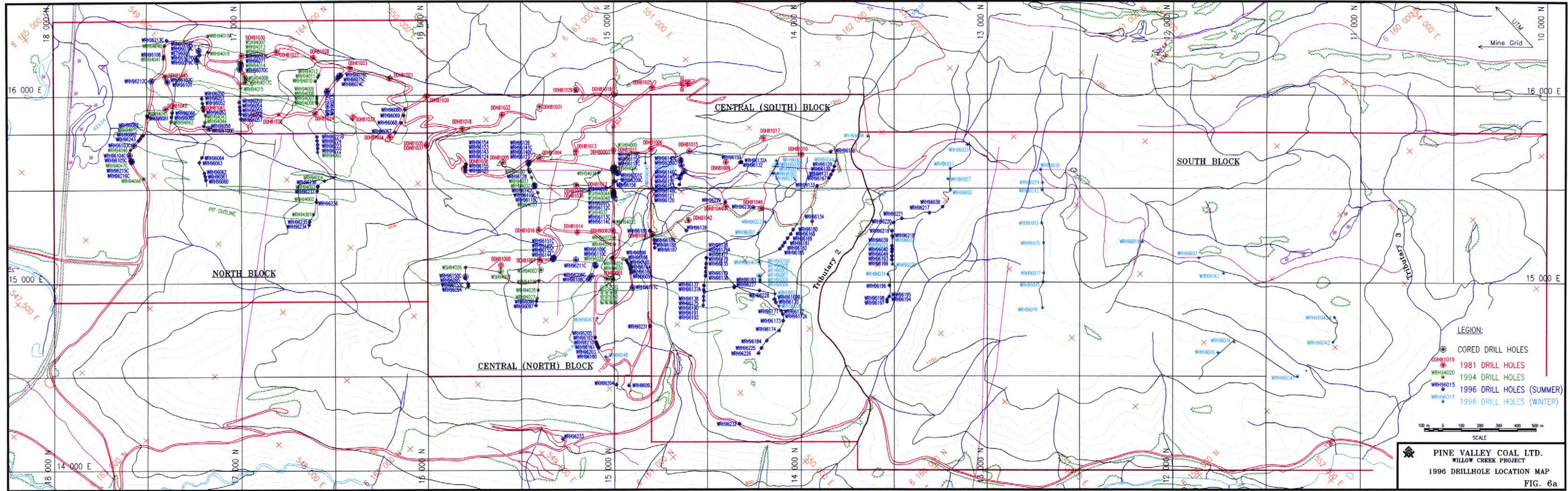



**PINE VALLEY COAL LTD.**  
 WILLOW CREEK PROJECT  
 1996 DRILLHOLE LOCATION MAP  
 FIG. 6a

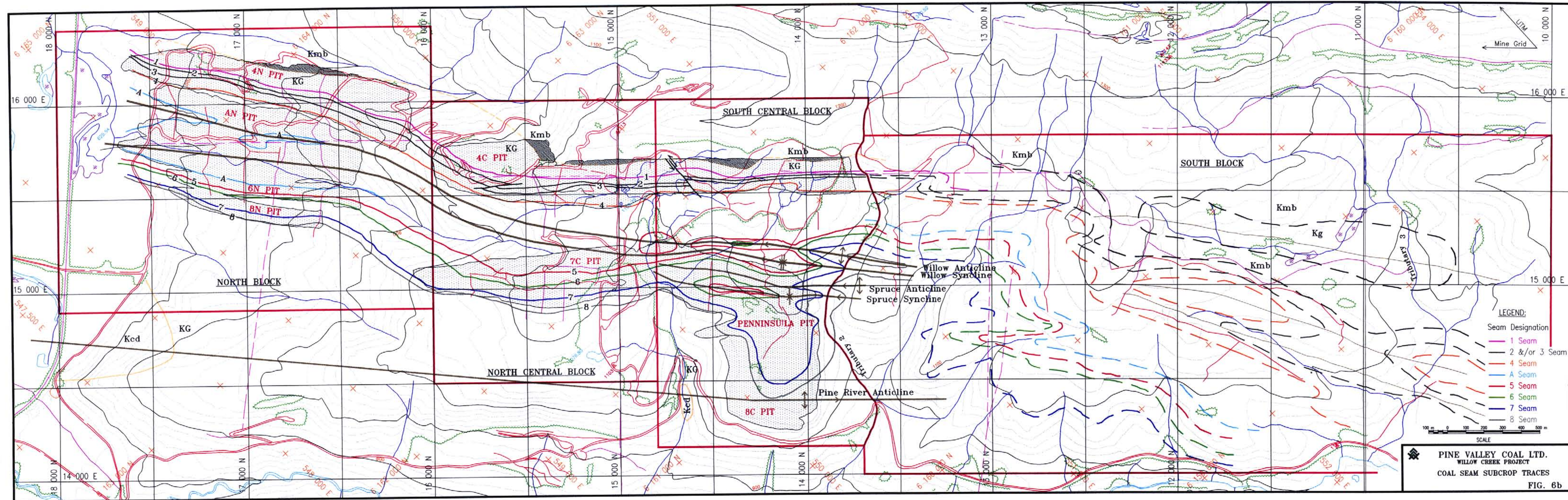



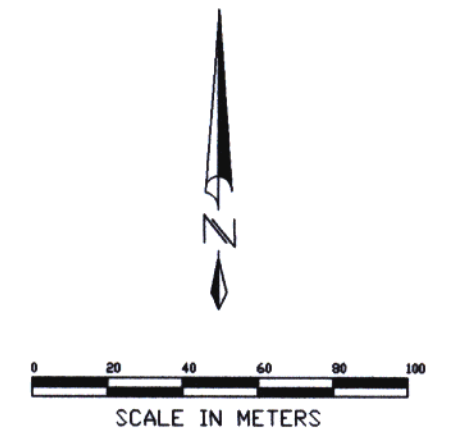
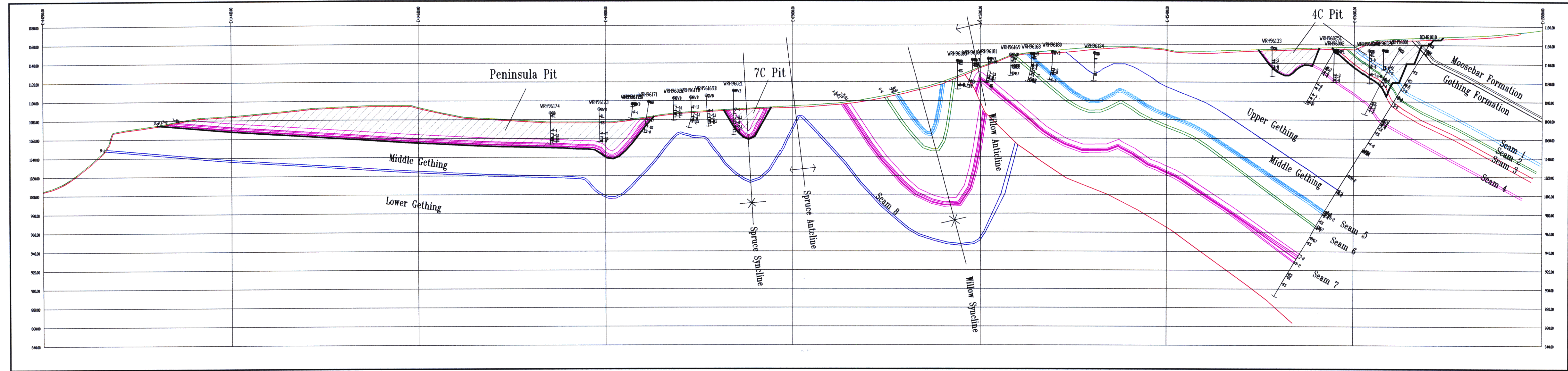





**PINE VALLEY COAL LTD.**  
 WILLOW CREEK PROJECT  
 GEOLOGICAL SECTION AND PIT OUTLINE  
 SECTION 14 000 N  
 FIG. 7a

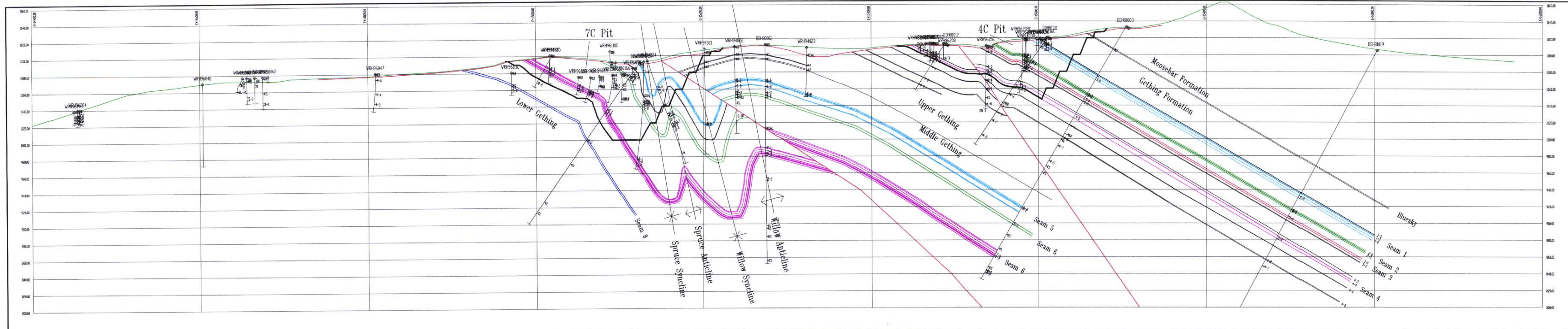



PINE VALLEY COAL LTD.  
WILLOW CREEK PROJECT

GEOLOGICAL SECTION AND PIT OUTLINE  
SECTION 15 000 N

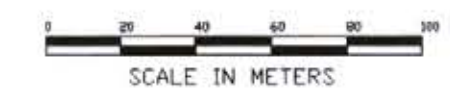
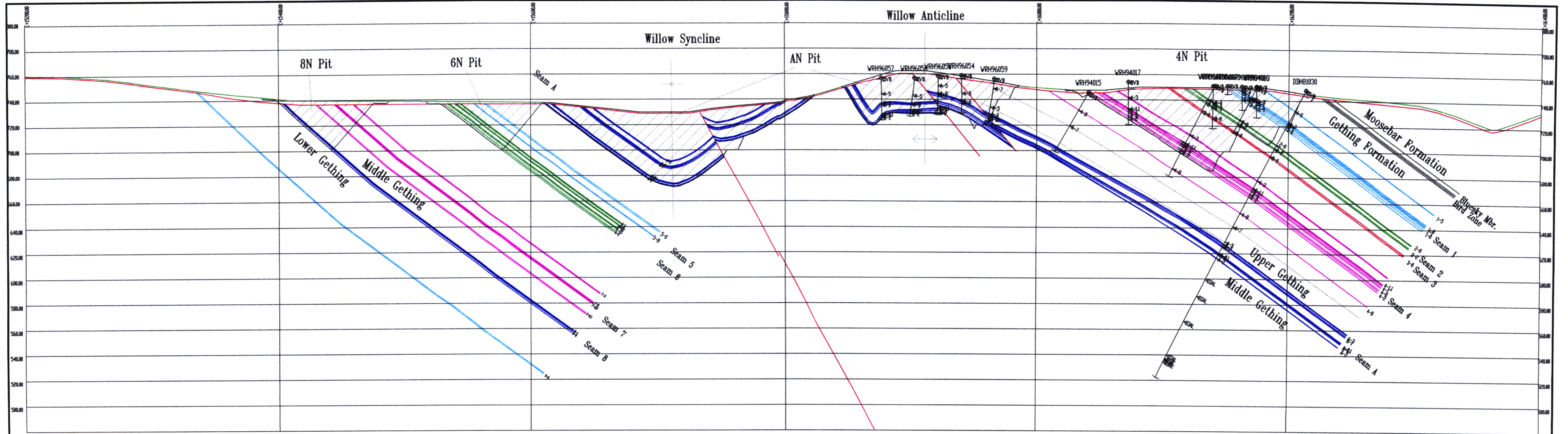

FIG. 7b





PINE VALLEY COAL LTD.  
WILLOW CREEK PROJECT

GEOLOGICAL SECTION AND PIT OUTLINE  
SECTION 17 000 N

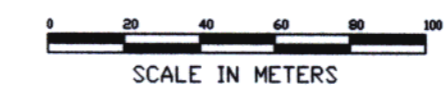

FIG. 7c

## 4.0 COAL QUALITY

### 4.1 Sampling Procedures

The core recovered from the spot core and bulk core phases of the program were visually logged. Core logging involved the recording of basic lithologies, sedimentary structures, fossiliferous zones, and structural features such as bedding and fractures. However, as the core was primarily from targeted coal seams, only the coal seams were logged. The seams, including roof and floor characteristics, were logged in detail with close reference to **borehole** geophysical logs from the same, or adjacent, **drillholes**. Columnar sections (seam profiles) were prepared from the written core logs for detailed sampling of the seam. Based upon the examination of the seam **profile**, samples of coal from the drill core were taken in geological increments and shipped to Loring Laboratories Ltd. for analyses.

### 4.2 Sample Identification and Location

The following **coal** quality tables can be cross-referenced with the Drillhole Summaries located in Appendix 1.1 for details on sample identifications and locations. Furthermore, Figure 5a illustrates the drillhole locations on plan view. In the case of the bulk sample holes, a single location per bulk sample is shown for clarity. Appendix 2 contains the complete laboratory analyses for sampling completed during 1996.

### 4.3 Proximate Analysis

The raw coal ash content of the coal seams sampled during 1996 range from 1.61% to 35.06 %, as shown on Table 4. Generally, most of the samples contain less than 20% ash contents.

Based upon clean coal composite studies and simple float sink data, it is clear that the Gething coals at Willow Creek clean to low ash contents. As shown in Table 5, these low clean ash values provide a comparative view of the rank of the coals, based upon volatile matter contents. Clearly, the rank of the coals increases from medium volatile bituminous at Seam 1 to low volatile bituminous at Seam 8. Furthermore, the upper seams (Seams 1 to A) can be tentatively grouped as medium volatile bituminous **coals**, and the lower seams (Seams 5 to 8) can be identified as low-volatile bituminous **coals**.

From their volatile contents, Seam A and Seam 4 appear to be marginally classified as low volatile coals. Nevertheless, their respective mean maximum reflectance values of 1.40 and 1.49 indicate they are medium volatile coals - albeit Seam A is only marginally so.

### 4.4 Sulphur Content

As shown on Table 5, the total sulphur contents for the coal seams are generally less than 0.80 percent on a clean **coal** basis, with the exception of 8 seam. The majority of the sulphur in the **coal** resides in the organic component. Pyritic sulphur is generally low with the exception of 2 and 8 seams where the pyritic component makes up over 0.20 percent. In all seams, the sulphate form sulphur is considered negligible.

#### 4.5 Ash Analyses

Based upon the mineral analysis shown on Table 6, the upper seams (1,3, & 4) have higher base/acid ratios than the lower seams (5 and 7). Seams 1,3, and 4 have **respective** average ratios of 0.36, 0.25, and 0.22 compared **to** respective ratios of 0.06 and 0.05 for Seam 5 and Seam 7. Seam 2 base/acid **ratios** range between 0.03 and 0.21. Seam 6 base/acid **ratios** have a high range, 0.09 to 1.15, which appears anomalous when compared **to** the 1994 data average of 0.08. The ratio for Seam 8 averages 0.16. Generally, the upper seams represent coals with higher ash slugging potential.

#### 4.6 Free Swelling Index

As shown on Table 5, the Free Swelling Index (FSI) for Seams 1 to 8 have an FSI range from 0 to 8. The lower seams (Seams 6 to 8) have a FSI range from 0 **to** 2, and the upper seams (Seams 1 to A) have a range from 1.5 to 8. Some of the upper seam lower FSI values represent oxidized coal samples.

#### 4.7 Other Tests

In addition to the above tests, selected petrographic analyses were completed and can be found in Appendix 2.8. Furthermore, washability studies and size analysis were completed and are presented in Appendix 2.3.



Table 4

1996 Exploration Program  
75 mm Drill Core Samples  
Raw Coal Analysis

Drillhole	Seam	A.R.	A.D.	Dry Basis				S	MJ/KG	FSI	HGI
				%H <sub>2</sub> O	%H <sub>2</sub> O	Ash %	VM %				
WRH96026C	1-0		0.67	14.70	21.02	64.28	•				
WRH96075C/76C	1	1.58	0.74	7.33							
WRH96077C	1-3	3.26	0.90	19.24	22.08	58.68	•	28.12			
WRH96077C	1-1	1.85	0.48	18.28	27.07	54.67	•	28.31			
WRH96077C	1-0	1.80	0.50	6.15	27.34	64.51	•	33.31	9		
WRH96078C	1	1.42	0.72	23.85	23.02	53.13	•				
WRH96140C	1-0	1.83	0.94	1.61	25.39	73.01	•		8		
WRH96141C	1-0	1.50	0.68	2.14	23.29	74.57	•	35.23	8	85	
WRH96145C/200C	1-0	2.88	0.31	7.82							
WRH96214C	1-0	2.79	0.90	4.40	20.63	74.97	•	34.52	2	84	
WRH96070C	2-0	1.50	0.93	20.80	21.01	58.19	•				
WRH96070C	2-2	1.33	0.85	34.36	17.21	48.44	•				
WRH96146C	2	1.15	0.67	35.06	17.65	47.29	•				
WRH96201C	2-2	3.54	0.80	26.61	19.98	53.43	•		5 1/2		
WRH96024C	3	6.08	0.61	11.40	20.87	87.73	•			88	
WRH96070C	3-0	1.44	0.80	19.94	20.05	60.01	•				
WRH96147C	3	2.74	0.99	22.59	18.04	59.37	•	28.47	1 1/2		
WRH96209C	3	3.21	0.92	11.48	19.66	68.97	•	31.88	2 1/2	75	
WRH96025C	4-1		0.49	19.10	19.89	61.21	•				
WRH96025C	4-0		0.60	12.64	20.14	67.22	•			108	
WRH96072C/73C	4	1.94	1.26	19.11							
WRH96079C/107C	4	1.62	0.52	10.11	20.18	89.7	•	32.25	4 1/2	77	
WRH96118C/119C/142C	4 . 0	1.91	0.50	6.79							

Table 4

**1996 Exploration Program  
75 mm Drill Core Samples  
Raw Coal Analysis**

Drillhole	Seam	A.R. %H <sub>2</sub> O	A.D. %H <sub>2</sub> O	Dry Basis				S %	MJ/KG	FSI	HGI
				Ash %	VM %	FC %					
WRH96119C	4-0	1.29	0.81	21.36	17.17	61.47	-	-	-	-	
WRH96148C	4-1	3.54	1.38	20.03	17.72	62.25	-	-	4	-	
WRH96148C	4-0	3.2	0.88	4.47	19.25	76.28	-	34.73	4	105	
WRH96207C	4-0	4.2	0.86	9.42	18.82	71.76	-	34.01	2	-	
WRH96100C/102C	A	1.79	0.76	19.39							
WRH96212C	A	2.04	0.78	18.60	18.8	63.22			3		
WRH96004C	5	2.58	0.77	2.45	16.95	80.6				75.00	
WRH96103C	5	1.28	0.70	5.78	16.36	77.85		33.8	1 1/2		
WRH96151C	5	2.45	1.00	3.67	16.16	80.17		36	1/2	77	
WRH96152C	5	1.92	0.80	4.00	16.24	79.76			1		
WRH96211C	5	1.96	0.82	11.63	16.17	72.2		31.41	1		
WRH96004C	6	3.63	0.82	4.60	16.17	79.33				70	
WRH96103C	6	1.3	0.62	12.18	18.87	66.95		31.19	1	67	
WRH96104C	6-4	1.26	0.59	16.42	16.51	87.08		30.1s	112	67	
WRH96109C/110C	6	1.87	0.33	5.21							
WRH96010C	7.0	3.1	0.83	10.42	16.91	73.67			1/2	71	
WRH96105C	7	1.27	0.64	7.57	16.58	75.86		33.81	1/2	70	
WRH96109C	7-0	5.69	0.91	15.76	14.04	70.2		32.59	0		
WRH96109C	7-2	5.07	0.83	20.26	13.36	70.2					
WRH96108C/208C	7	1.83	0.25	12.81							
WRH96215C	7.2	2.43	0.77	10.01	13.66	76.33		32.61	1/2		
WRH96216C	7.2	2.15	0.79	9.70	15.1	75.2		32.71	1 1/2		

Table 4

1996 Exploration Program  
75 mm Drill Core Samples  
Raw Coal Analysis

Drillhole	Seam	A.R.	A.D.	Ash	VM	Dry Basis		MJ/KG	FSI	HGI
		%H2O	%H2O	%	%	FC	S			
						%	%			
WRH96105C	8	1.92	0.70	4.75	14.44	80.81		35.16	1/2	74
WRH96111C	8		0.90	12.32	17.2	70.47		30.97	1	71
WRH96215C	8	2.67	0.76	13.74	14.54	71.72		31.32	1/2	

Table 5

1996 Exploration Program  
75 mm Drill Core Samples  
Clean Coal Analysis

Drillhole	Seam	Basis Size @ Float SG	A.D. %H <sub>2</sub> O	Ash %	VM %	Dry Basis			FSI	HGI
						FC %	S %	MJ/KG		
WRH96026C	1-0	+0.15mm @1.80SG	0.95	7.12	22.73	70.16	0.44		4	104
WRH96075C/76C	1	+0.15mm @1.70SG	0.67	4.44	23.34	72.22	0.53		7	-
WRH96077C	1-3	+0.15mm @1.70SG	0.74	6.01	24.67	69.32		33.90	8	-
WRH96077C	1-1	+0.15mm @1.70SG	0.94	7.60	22.66	69.54		32.73	1/2	-
WRH96077C	1-0	+0.15mm @1.70SG	0.60	6.99	26.76	66.25		33.66	9	-
WRH96078C	1	+0.15mm @1.70SG	0.57	5.90	22.65	71.45	0.62		4 1/2	-
WRH96140C	1-0	+0.15mm @1.70SG	0.77	1.04	26.16	72.60	0.55		8	-
WRH96141C	1-0	+0.15mm @1.70SG	0.76	1.50	23.30	75.20	0.54		6	90
WRH96145C/200C	1-0	+0.15mm @1.70SG	0.39	3.20	23.73	73.06	0.44		7 1/2	-
WRH96214C	1-0	+0.15mm @1.70SG	0.29	2.67	23.97	73.36	0.56		8	84
WRH96070C	2-0	+0.15mm @1.70SG	0.65	6.57	24.03	69.4	0.67	33.47	9	-
WRH96070C	2-2	+0.15mm @1.70SG	0.52	7.04	21.46	71.5	0.74	33.36	3 1/2	-
WRH96070C	2	+0.15mm @1.70SG	0.46	9.96	21.49	66.54			6 1/2	-
WRH96146C	2	+0.15mm @1.70SG	0.56	5.91	21.16	72.91	0.67	33.92	4 1/2	-
WRH96201C	2-0	+0.15mm @1.70SG	0.39	6.36	22.31	71.33	0.71		8	89
WRH96201C	2-2	+0.15mm @1.70SG	0.57	5.73	22.77	71.5	0.61		8	87
WRH96024C	3	+0.15mm @1.80SG	0.76	5.64	21.53	72.63	0.47		2	-
WRH96070C	3-0	+0.15mm @1.70SG	0.62	6.54	21.54	71.92	0.66	33.5	5 1/2	-
WRH96147C	3	+0.15mm @1.70SG	0.66	4.31	21.36	74.31	0.43	34.05	1 1/2	73
WRH96209C	3	+0.15mm @1.70SG	0.40	4.68	20.9	74.22	0.5		2	79
WRH96025C	4-1	+0.15mm @1.80SG	1.13	9.70	23.49	66.62			7 1/2	-
WRH96025C	4-0	+0.15mm @1.80SG	0.67	6.70	21.71	71.59			3	-
WRH96025C	4	-9mm @1.80SG	0.96	7.99	24.36	67.65	0.62		3 1/2	116

Table 5

1996 Exploration Program  
75 mm Drill Core Samples  
Clean Coal Analysis

Drillhole	Seam	Basis Size @ Float SG	A.D. %H <sub>2</sub> O	Ash %	VM %	Dry Basis			FSI	HGI
						FC %	S %	MJ/KG		
WRH96072C/73C	4	+0.15mm @1.70SG	0.82	3.63	20.67	75.7	0.52		3	
WRH96079C/107C	4	+0.15mm @1.70SG	0.68	4.41	21.14	74.46	0.46		3 1/2	81
WRH96118C/119C/142C	4-0	+0.15mm @1.70SG	0.82	3.63	20.67	75.7	0.52		3	
WRH96119C	4-0	+0.15mm @1.70SG	0.25	6.26	20.22	73.52	0.51		1 1/2	
WRH96148C	4-1	+0.15mm @1.70SG	0.62	5.74	18.99	75.28	0.68	33.37	2 1/2	92
WRH96148C	4-0	+0.15mm @1.70SG	0.72	2.66	19.57	77.77	0.58	34.87	4	121
WRH96207C	4-0	+0.15mm @1.70SG	0.88	4.95	20.95	74.09	0.52		1 1/2	
WRH96100C/102C	A	+0.15mm @1.70SG	0.69	7.37	19.67	72.96	0.67		3 1/2	
WRH96212C	A	+0.15mm @1.70SG	0.58	6.61	20.38	73.03	0.7	33.77	4	
WRH96004C	5	+0.15mm @1.80SG	0.64	2.24	17	80.76	0.61		-	
WRH96103C	5	+0.15mm @1.70SG	0.44	3.44	16.54	80.02	0.84	34.71	1 1/2	64
WRH96151C	5	+0.15mm @1.70SG	0.61	2.41	16.76	80.82	0.69	34.84	1/2	85
WRH96152C	5	+0mm @1.70SG		2.90	17.8	79.3	0.57		1	
WRH96211C	5	+0.15mm @1.70SG	0.42	3.08	16.52	80	0.73		2	75
WRH96004C	6	+0.15mm @1.80SG	0.84	2.98	16.54	80.48	6.55		-	
WRH96103C	6	+0.15mm @1.70SG	0.70	6.42	18.33	75.35	0.7		1/2	66
WRH96104C	6-4	+0.15mm @1.70SG	0.89	3.27	16.68	79.85	0.96	34.86	1/2	
WRH96109C/110C	6	+0.15mm @1.70SG	0.49	2.84	15.28	81.87	0.56		0	
WRH96010C	7-0	+0.15mm @1.80SG	0.66	5.63	17.22	76.95			-	
WRH96010C	7-2	+0.15mm @1.80SG	0.60	7.07	16.77	76.76			-	
WRH96105C	7-2	+0.15mm @1.70SG	0.56	5.34	16.78	77.88	0.7	34.1	1/2	70
WRH96109C	7-0	+0.15mm @1.70SG	0.82	4.23	15.11	60.66	0.48		1/2	
WRH96109C	7-2	+0.15mm @1.70SG	0.87	3.76	16.64	79.59	0.79		1/2	

Table 5

1996 Exploration Program  
75 mm Drill Core Samples  
Clean Coal Analysis

Drillhole	Seam	Basis Size @ Float SG	A.D. %H <sub>2</sub> O	Ash %	VM %	Dry Basis			FSI	HGI
						FC %	S %	MJ/KG		
WRH96108C/206C	7	+0.15mm @1.70SG	0.53	2.99	15.78	81.23	0.62	-	2	-
WRH96215C	7-2	+0.15mm @1.70SG	0.59	6.92	14.9	78.18	0.68	34.07	1 1/2	-
WRH96216C	7-2	+0.15mm @1.70SG	0.70	5.81	15.02	79.17			1	
WRH96105C	8	+0.15mm @1.70SG	0.60	3.12	15.31	81.57	1.1	35.29	1/2	66
WRH96111C	8	+0.15mm @1.70SG	0.83	7.21	17.24	75.55	1.28	-	2	92
WRH96215C	8	+0.15mm @1.70SG	0.44	3.85	15.12	81.04	0.95	-	112	71

Table 6  
1996 Exploration Program  
Ash Analysis

Drillhole	Seam	Ash % (db)	SiO <sub>2</sub> %	Al <sub>2</sub> O <sub>3</sub> %	TiO <sub>2</sub> %	Fe <sub>2</sub> O <sub>3</sub> %	CaO %	MgO %	Na <sub>2</sub> O %	K <sub>2</sub> O %	P <sub>2</sub> O <sub>5</sub> %	SO <sub>3</sub> %	Undet %
WRH96026C	1-0	7.12	49.53	21.79	0.74	12.16	3.64	1.03	0.85	0.92	1.38	2.95	5.01
WRH96075C/76C	1	4.44	49.00	31.05	0.23	6.64	3.79	0.95	2.89	0.43	1.94	2.71	0.37
WRH96078C	1	5.90	39.97	22.26	1.13	22.17	3.65	1.18	1.69	0.43	2.73	1.69	3.06
WRH96140C	1-0	1.04	35.70	32.60	1.56	7.87	4.27	0.96	5.87	0.90	2.26	5.73	2.26
WRH96141C	1-0	1.50	35.27	40.16	0.25	5.01	4.90	1.18	4.16	0.35	1.81	2.20	4.71
WRH96145C/200C	1-0	3.20	42.20	26.33	1.65	13.73	2.71	0.95	3.43	0.43	2.83	2.28	3.46
WRH96214C	1-0	2.67	34.00	18.18	0.86	25.74	5.39	3.04	3.02	0.30	0.63	5.56	3.28
WRH96070C	2-0	6.57	56.28	33.08	2.30	0.66	1.75	0.17	0.98	0.29	2.81	0.15	1.55
WRH96070C	2-2	7.04	65.66	26.66	1.85	0.72	1.06	0.38	0.69	0.36	1.76	0.41	0.45
WRH96146C	2	5.91	55.05	34.72	0.73	1.30	1.34	0.32	1.67	0.91	3.32	0.55	0.09
WRH96201C	2-2	5.73	47.94	26.58	1.30	8.58	3.55	1.34	1.90	0.73	2.23	2.43	3.42
WRH96024C	3	5.84	47.30	22.36	0.85	15.49	3.04	0.91	0.72	0.62	1.10	3.77	3.84
WRH96070C	3	6.54	58.26	30.27	2.00	1.13	1.75	0.35	1.12	0.71	3.71	0.32	0.38
WRH96147C	3	5.84	47.30	22.36	0.85	15.49	3.04	0.91	0.72	0.62	1.10	3.77	3.84
WRH96209C	3	4.88	41.24	26.84	1.16	16.80	3.96	0.96	2.06	0.31	2.75	2.92	0.98
WRH96025C	4	7.99	48.23	23.30	0.66	12.30	3.47	1.44	0.63	0.82	0.89	3.29	4.97
WRH96072C/73C	4	6.44	55.75	25.99	1.10	2.99	3.01	0.93	1.40	0.90	2.08	2.26	3.59
WRH96079C/107C	4	4.41	54.67	25.83	1.17	4.49	2.80	0.63	2.25	0.36	2.22	2.26	3.32
WRH96118C/142C	4-0	2.34	37.30	29.30	0.38	17.27	4.41	1.66	3.17	0.30	2.44	2.47	1.30
WRH96148C	4-1	5.74	41.25	40.45	0.63	1.29	2.46	0.20	1.19	0.24	9.27	1.22	1.80
WRH96148C	4-0	2.66	39.15	31.94	0.42	11.72	5.04	1.08	2.36	0.28	3.07	3.05	1.89
WRH96207C	4-0	9.76	47.40	23.98	0.78	16.44	2.55	0.91	1.04	0.42	0.62	2.15	3.71
WRH96100C/102C	A	7.37	53.38	28.54	1.00	5.38	3.30	0.48	1.11	0.44	2.25	1.72	2.40
WRH96212C	A	6.61	54.07	29.09	1.03	2.12	2.81	0.50	1.12	0.40	4.40	1.05	3.41
WRH96103C	5	3.44	58.70	33.60	0.35	2.16	1.36	0.28	1.35	0.28	2.27	0.44	0.79
WRH96151C	5	2.41	62.10	28.33	1.58	1.62	1.37	0.25	1.69	0.54	1.25	0.62	0.65
WRH96211 C	5	3.08	60.36	25.48	0.94	2.66	1.20	0.25	1.46	0.48	2.08	1.21	3.88

Table 6  
1996 Exploration Program  
Ash Analysis

Drillhole	Seam	Ash % (db)	SiO <sub>2</sub> %	Al <sub>2</sub> O <sub>3</sub> %	TiO <sub>2</sub> %	Fe <sub>2</sub> O <sub>3</sub> %	CaO %	MgO %	Na <sub>2</sub> O %	K <sub>2</sub> O %	P <sub>2</sub> O <sub>5</sub> %	SO <sub>3</sub> %	Undet %
WRH96004C	6	2.98	46.95	18.90	0.34	17.88	3.15	1.46	1.32	0.48	0.46	4.75	4.31
WRH96103C	6	6.42	32.52	8.51	0.60	37.36	5.37	4.12	1.00	0.14	3.93	5.46	0.99
WRH96109C/110C	6	2.84	60.20	25.19	1.08	3.79	1.57	0.42	1.92	0.42	2.03	0.31	3.07
WRH96105C	7-2	5.34	73.00	17.77	0.63	0.80	1.22	0.22	1.31	0.36	1.80	0.19	2.70
WRH96215C	7-2	6.92	75.57	15.65	1.40	0.80	1.45	0.20	0.99	0.28	1.86	0.47	1.33
WRH96108C/206C	7	4.58	63.73	20.79	0.91	1.98	2.47	1.41	1.33	1.00	1.31	1.42	3.65
WRH96105C	8	3.12	51.35	24.01	0.32	14.30	2.07	0.38	2.09	0.53	2.06	1.08	1.82
WRH9611 1C	8	7.21	57.38	29.48	1.00	5.36	1.09	0.30	0.73	0.91	2.27	0.43	1.05
WRH96215C	8	3.85	57.05	26.57	0.75	4.72	2.18	0.38	2.04	0.48	2.74	0.17	2.92



**Table 7**  
**1996 Exploration Program**  
**Ash Fusion Temperatures**  
**(Reducing)**

Drillhole	Seam	Ash %(ad)	Initial °C	Soften °C	Hemisph °C	Fluid °C
WRH96075C/76C	1	4.44	1291	1337	1342	+1426
WRH96078C	1	5.90	1027	1058	1167	1203
WRH96141 C	1-0	1.50	1259	1203	1234	1291
WRH96145C/200C	1-0	3.20	1074	1087	1110	1278
WRH96214C	1-0	2.67	1069	1079	1081	1125
WRH96070C	2-0	6.57	+1426	+1426	+1426	+1426
WRH96070C	2-2	7.04	+1426	+1426	+1 426	+1426
WRH96146C	2	5.91	+1426	+1426	+1426	+1426
WRH96201C	2-2	5.73	1239	1306	1327	1420
WRH96070C	3	6.54	+1426	+1426	+1 426	+1426
WRH96147C	3	5.84	1056	1063	1069	1203
WRH96209C	3	4.88	1089	1128	1167	1296
WRH96072C/73C	4	6.44	1286	1353	1386	+1426
WRH96079C/107C	4	4.41	1291	1389	1410	+1426
WRH96118C/142C	4-0	2.34	1061	1094	1162	1288
WRH96148C	4-0	2.66	1182	1213	1224	1378
WRH96207C	4-0	9.76	1187	1265	1278	1296
WRH96100C/102C	A	7.37	1167	1397	1410	+1426
WRH96212C	A	6.61	1286	+1426	+1426	+1426
WRH96103C	5	3.44	1417	+1426	+1426	+1 426
WRH96151 C	5	2.41	+1426	+1426	+1426	+1426
WRH96211 C	5	3.08	1335	1417	+1426	+1426
WRH96103C	6	6.42	1084	1089	1094	1110
WRH96109C/110C	6	2.84	1358	1386	1420	+1426
WRH96105C	7-2	5.34	1415	+1426	+1 426	+1426
WRH96215C	7-2	6.92	1420	+1426	+1426	+1426
WRH96108C/206C	7	2.99	1348	1417	+1426	+1426
WRH96105C	8	3.12	1110	1172	1203	1286
WRH96111 C	8	7.21	+1426	+1426	+1426	+1426
WRH96215C	8	3.85	1141	1205	1358	1417

## 5.0 CONCLUSIONS

The 1996 Exploration Program extended the known presence of medium-volatile bituminous **coals** and low-volatile bituminous coals further south from the 1994 and 1981 exploration programs. The extension of the coal measures provides a future source of coal should mine development proceed.

## 6.0 REFERENCES

B.C. Ministry of Mines, Energy and Petroleum Resources (1992): British Columbia Coal Quality Catalogue. information Circular 1992-20.

(1989): British Columbia Coal Quality Catalogue, Information Circular 1989-22.

Gibson, D.W. (1972): Triassic Stratigraphy of the Pine Pass - Smoky River Area, Rocky Mountain Foothills and Front Ranges of B.C. and Alberta; G.S.C. Paper 7130.

Gibson, D.W. (1992): Stratigraphy, Sedimentology. Coal Geology and Depositional Environments of the Lower Cretaceous Gething Formation, Northeastern British Columbia and West-Central Alberta

Hughes, J.E. (1984): Jurassic and Cretaceous Strata of the Bullhead Succession in the Peace and Pine River Foothills; B.C. Dept. of Mines and Pet. Res., Bull. No 51.

(1967): Geology of the Pine Valley, Mount Wabi to Solitude Mountain, Northeastern British Columbia; B.C. Dept. of Mines & Pet. Res., Bull. No 52.

Jones, H.M. (1979): Report on the Geological Mapping Program on Parts of Coal Licenses 3986-3993 inclusive; Liard Mining Division, Assessment Report.

Jones, H.M. (1980): Assessment Report on the Geological Mapping Program on Pads of Coal Licenses 3986-3993 inclusive; Liard Mining Division.

Jones, H.M. (1981): Progress Report of work performed on Coal Licenses 3986-3993 inclusive, Pine River Area, Liard Mining Division.

Legun, A. (1984): Stratigraphic and Depositional Relationships Between the **Bluesky** Marker Unit, Gething Marine Tongue, and Upper Coal Measures of the Gething Formation (930 and P); Geological Fieldwork, 1983; BCMEMPR Paper 1984-1.

McLearn, F.H. and Kindle, E.D. (1950): Geology of Northeastern British Columbia; Geol. Surv. Can., Mem 259.

McKechnie, N.D. (1955): Coal Reserves of the Hasler Creek-Pine River Area: B.C. Dept. of Mines, Bull No 36.

Marton, A.S. and Jones, H.M. (1981): Diamond Drilling and Trenching Report on Coal Licenses 3986 to 3993 inclusive and 6792, Pine River Area, Liard Mining Division.

Marion, A.S. (Dec. 1981) Diamond Drilling & Trenching Report on Coal Licenses 3986 to 3993 inclusive, 6792, 7191 & 7192, Pine River Area, Liard Mining Division.

Spivak, J. (1944): Geology and Coal Deposits of Hasler Creek Area, British Columbia,

Stott, D.A. (1960): Lower Cretaceous Bullhead and Fort St. John Groups, between Smoky and Peace Rivers, Rocky Mountain Foothills, Alberta and British Columbia: **Geol. Surv. Can. Bull. No 152**, pp279.

(1971): Lower Cretaceous Bullhead Group between Bullmoose Mountain and Tetsa River, Rocky Mountain Foothills, Northeastern **British** Columbia; Geol. Surv. Can. Open File Report.

(1974): Lower Cretaceous Coal Measures of Foothills of West Central Alberta and Northeastern British Columbia; C.I.M. Bull. Sept. 1974.

(1982): Lower Cretaceous fort St. John Group and Upper Cretaceous **Dunvegan** Formation of the Foothills and Plains of Alberta, British Columbia, District of Mackenzie and Yukon Territory; Geol. Surv. of Can. Bull. 328

## 7.0 EXPENDITURES

### 1996 Exploration Program Expenditure Summary

<b>Item Description</b>	<b>Item cost</b>
<i>Supervision</i>	<b>\$129,958</b>
<b>Access/Road</b> <i>Building</i>	<b>\$290,500</b>
<i>Drilling</i>	<b>\$387,103</b>
<i>Geophysics</i>	<b>\$92,303</b>
<i>Accommodation</i>	<b>\$11,385</b>
<i>Transportation</i>	<b>\$13,367</b>
<i>Survey</i>	<b>\$43,038</b>
<i>Equipment Rentals</i>	<b>\$13,775</b>
<i>Materials/Supplies</i>	<b>\$8,299</b>
<b>Total</b>	<b>\$989,728</b>

# **APPENDIX 1**

## **DRILLHOLES**

**APPENDIX 1 .I**

**Drillhole UTM Locations  
NAD 27**

**1996 Drill Hole Collar  
Survey Summary  
NAD27 UTM**

<b>Drillhole</b>	<b>Northing (m)</b>	<b>Easting (m)</b>	<b>Elevation (m)</b>	<b>Depth (m)</b>
WRHS6001	6161702.91	548840.03	1156.00	80.00
WRH96002	6161665.15	548898.41	1154.00	65.00
WRH96003	6161506.26	549187.38	1123.50	130.00
WRH96004C	6161398.33	549297.16	1131.10	130.00
WRH96005	6161347.56	549350.04	1122.90	45.00
WRH96006	6161325.18	549370.40	1121.40	39.00
WRH96007	6161331.53	549362.05	1121.50	35.00
WRH96008	6161347.93	549349.52	1123.00	62.00
WRH96009	6161328.86	549362.53	1121.40	67.50
WRH96010C	6161346.96	549348.58	1123.10	43.00
WRH96011	6160995.66	548235.30	1170.00	57.00
WRH96012	6160555.56	547982.78	1183.20	62.00
WRH98013	6160435.75	548112.95	1172.40	97.00
WRH96014	6160580.57	547952.43	1182.10	56.00
WRH96015	6160215.88	548334.67	1169.10	102.00
WRH96016	6160124.94	54643794	1164.60	57.00
WRH96017	6160245.74	548298.88	1170.60	57.00
WRH96018	6160636.07	547908.99	1187.40	69.00
WRH96019	6159973.52	547813.21	1197.40	89.00
WRH96020	6159274.71	547967.44	1136.40	96.00
WRH96021	6161222.95	549363.06	1110.70	47.00
WRH96022	6161163.81	549395.63	1102.90	24.00
WRH96023	6161520.04	549118.39	1134.50	42.00
WRH96024C	6161685.70	548868.66	1153.70	35.00
WRH96025C	6161670.13	548903.79	1154.00	34.00
WRH96026C	6161686.78	548849.05	1154.30	21.00
WRH96027	6160965.00	548284.38	1168.10	110.00
WRH96028	6160915.16	548318.12	1164.80	37.00
WRH96029	6160929.18	548763.29	1123.60	121.00
WRH96030	6160872.75	548821.23	1125.90	97.00
WRH96031	6160854.10	548875.90	1118.50	45.00
WRH96032	6160967.94	548716.78	1131.50	99.00
WRH96033	6161014.31	548080.89	1180.30	120.00
WRH96034	6161434.69	546411.15	1160.00	152.00
WRH96035	6160355.32	548182.03	1169.20	132.00
WRH96036	6159250.72	547866.48	1138.80	45.00
WRH96037	6159694.19	547669.29	1154.00	46.00
WRH96038	6160884.84	548412.78	1155.58	30.48
WRH96039	6160941.72	548751.31	1123.65	17.40
WRH96040	6160930.67	548760.60	1123.39	30.48
WRH96041	6158875.68	547768.17	1118.30	97.00
WRH96042	6158860.70	547503.28	1132.50	97.00
WRH96042A	6158945.47	547401.93	1136.00	16.00
WRH96043	6159542.79	547638.93	1156.60	96.00
WRH96044	6161467.62	548625.17	1157.24	98.00



**1996 Drill Hole Collar  
Survey Summary  
NAD27 UTM**

<b>Drillhole</b>	<b>Northing (m)</b>	<b>Easting (m)</b>	<b>Elevation (m)</b>	<b>Depth (m)</b>
WRH96045	6162204.98	549327.69	1121.82	98.00
WRH96046	6162068.59	549187.30	1131.50	98.00
WRH96047	6161833.85	550109.94	1080.36	45.00
WRH96048	6161680.57	550228.91	1070.08	98.00
WRH98049	6160920.25	548774.32	1123.05	30.48
WRH98050	6164182.08	550692.38	732.83	15.24
WRH96051	8164161.22	550709.24	730.95	17.37
WRH96052	8164146.02	550721.49	729.68	8.10
WRH96053	6164131.29	550734.23	729.93	21.34
WRH96054	6164002.32	550588.97	758.96	29.80
WRH96055	6163988.72	550601.42	758.45	30.48
WRH96056	6163975.15	550614.33	756.90	30.48
WRH96057	6163955.12	550631.68	756.81	33.53
WRH96058	6164074.23	550792.44	722.70	27.00
WRH96059	6164022.19	550572.07	756.34	33.70
WRH96060	8163871.74	550997.87	713.40	21.34
WRH96061	6163888.78	550986.69	714.55	21.34
WRH96082	6163902.46	550976.66	717.40	33.53
WRH98063	6163960.37	550953.18	716.98	12.19
WRH96064	6163968.49	550924.16	713.20	33.53
WRH96065	6164232.61	550873.78	698.51	27.43
WRH96066	6164245.00	550854.02	699.14	15.24
WRH96067	6163299.74	550121.76	913.40	33.53
WRH96066	6763311.47	550082.88	914.33	12.19
WRH96069	6163327.48	550024.30	916.36	12.19
WRH96070C	6164137.98	550442.15	751.25	33.50
WRH96071	6164143.45	550431.78	751.33	6.70
WRH96072C	6163715.89	550214.59	830.25	66.70
WRH96073C	6163716.88	550206.94	830.24	84.90
WRH96074C	6163723.35	550125.18	823.64	44.60
WRH96075C	6163723.11	550105.39	823.00	35.00
WRH96076C	6183722.85	550102.04	823.04	33.50
WRH96077C	6164149.29	550421.64	751.07	18.60
WRH96078C	6164368.51	550517.98	706.27	32.00
WRH96079C	6164334.25	550566.09	707.17	72.00
WRH96080	6183344.31	549997.51	912.88	30.48
WRH96081	6164330.40	550957.84	663.63	21.34
WRH96082	6164276.58	551070.61	656.89	14.78
WRH96083	6164277.84	551049.37	657.92	9.18
WRH96093	6161463.13	550254.62	1038.18	15.00
WRH96094	6162454.92	550453.88	1058.99	15.00
WRH96095	6162495.25	550435.66	1063.03	27.00
WRH96096	6162132.87	550264.49	1126.05	32.00
WRH96097	8162119.49	550282.74	1125.45	32.60
WRH96098	6161925.54	549776.04	1085.12	20.00
WRH96099	6161863.20	549806.88	1074.93	21.00

**1996 Drill Hole Collar  
Survey Summary  
NAD27 UTM**

<b>Drillhole</b>	<b>Northing (m)</b>	<b>Easting (m)</b>	<b>Elevation (m)</b>	<b>Depth (m)</b>
WRH96100C	6164046.39	550785.36	724.92	30.50
WRH96101	6164374.98	550752.01	694.96	37.80
WRH96102C	6164376.60	550752.39	694.90	44.80
WRH96103C	6164277.33	551121.17	649.72	56.50
WRH96104C	6164257.64	551175.38	642.75	19.50
WRH96105C	6164230.93	551191.06	641.55	43.60
WRH96106C	6164482.17	550664.74	685.48	62.00
WRH96107C	6164349.66	550554.04	706.02	68.00
WRH96108C	6162005.21	549989.88	1109.75	47.00
WRH96109C	6162031.37	549909.21	1105.51	84.00
WRH961 10C	6162029.30	549909.98	1105.17	23.00
WRH96111C	6161803.45	549860.03	1080.57	26.50
WRH96112C	6162219.51	549564.35	1113.60	21.00
WRH96113C	6162214.60	549569.17	1113.40	15.50
WRH961 14C	6162208.55	549575.10	1112.81	10.00
WRH96115C	6162311.13	549471.34	1119.64	11.00
WRH96116C	8162311.67	549461.46	1120.18	15.70
WRH96117C	6162303.95	549470.26	1119.50	9.00
WRH96118C	6162557.65	549822.83	1087.17	37.00
WRH96119C	6162559.20	549821.85	1087.16	49.00
WRH96120	6161993.25	549287.14	1115.20	6.00
WRH96121	6162015.66	549262.06	1120.39	21.00
WRH96122	6162023.63	549234.26	1124.17	15.10
WRH96123	6162906.44	549987.74	1067.48	15.00
WRH96124	6162896.30	550000.81	1068.84	12.00
WRH96125	6162881.68	550018.83	1069.57	18.00
WRH96126	6162667.36	549745.36	1096.85	30.00
WRH96127	6162658.25	549763.05	1095.58	18.00
WRH96128	6162628.47	549788.17	1095.38	118.30
WRH96129	6161454.50	548650.65	1155.93	35.00
WRH96130	6161444.33	548672.39	1154.92	30.00
WRH96131	6161438.18	548694.77	1155.61	30.00
WRH96132	6161830.15	548972.87	1158.58	25.00
WRH96132A	6161831.40	548970.29	1158.34	26.00
WRH96133	6161450.97	548789.96	1156.50	30.48
WRH96134	6181341.43	548946.79	1150.56	30.00
WRH96135	6161573.41	549530.93	1083.07	30.00
WRH98136	6161560.61	549547.11	1080.75	25.00
WRH96137	6161532.08	549591.21	1078.20	5.00
WRH96137A	8161529.85	549590.75	1078.44	30.00
WRH96138	6161517.67	549608.58	1079.51	30.00
WRH96139	6161798.45	549441.32	1103.52	25.00
WRH96140C	6162664.19	549754.97	1096.26	43.00
WRH96141C	6162665.78	549754.31	1096.23	28.00
WRH96142C	6162560.62	549820.76	1087.27	30.00
WRH96143	6162898.91	550002.22	1068.37	80.30

**1996 Drill Hole Collar  
Survey Summary  
NAD27 UTM**

<b>Drillhole</b>	<b>Northing (m)</b>	<b>Easting (m)</b>	<b>Elevation (m)</b>	<b>Depth (m)</b>
WRH96144	6162220.00	550042.08	1100.92	20.00
WRH96145C	6162077.45	549188.87	1131.34	25.50
WRH96146C	6162054.31	549204.43	1130.01	19.50
WRH96147C	6162023.14	549216.79	1125.54	39.50
WRH96148C	6162018.80	549257.83	1121.12	27.30
WRH96149C	6162221.40	550034.24	1100.80	<b>25.40</b>
WRH96150C	6162500.77	550428.54	1063.03	38.30
WRH96151C	6182221.66	550033.07	1100.77	26.40
WRH96152C	6162220.92	550037.32	1100.84	26.00
WRH96153C	6162464.51	550448.14	1058.57	28.80
WRH96154	6162905.13	549987.45	1087.75	75.00
WRH96155	6162888.25	550015.18	1089.23	83.00
WRH98156	6162258.60	549510.63	1110.72	75.00
WRH96157	6162021.94	549238.49	1123.24	68.00
WRH96158	6161522.77	548606.92	1165.78	117.35
WRH98159	6161835.60	548977.43	1158.14	88.87
WRH96160	6161719.50	550219.10	1076.56	18.40
WRH96161	6161734.54	550213.80	1077.10	30.48
WRH96162	6161749.47	550206.09	1077.74	6.10
WRH98163	6161874.79	549797.80	1074.43	30.48
WRH96164	6161884.55	549792.01	1075.58	27.00
WRH96165	6161898.59	549783.79	1077.17	33.53
WRH96166	6161911.25	549780.34	<b>1078.16</b>	33.53
WRH96167	6161433.83	548715.07	1155.95	30.48
WRH96168	6161379.91	549075.09	1149.54	30.40
WRH96169	6161376.90	549102.83	1148.86	23.00
WRH96169B	6161205.18	549386.74	1105.70	33.30
WRH96170	6161188.81	549394.31	1103.67	33.00
WRH96171	6161137.80	549408.07	1099.12	33.50
WRH96172	6161119.87	549415.09	1096.78	16.00
WRH96172A	6161119.58	549415.33	1096.64	3.00
WRH96173	6161093.76	549439.74	1091.15	34.95
WRH96174	8161073.81	549492.47	1088.99	33.40
WRH96175	6161506.65	549614.27	1080.47	30.30
WRH96176	6161621.62	549474.73	1083.06	6.10
WRH96176A	6161620.55	549473.78	1083.07	13.00
WRH96177	6161600.73	549497.78	1087.68	18.10
WRH98178	6161587.81	549514.70	1085.74	15.20
WRH96179	6161559.95	549548.02	1080.76	27.00
WRH98180	6161386.04	549049.71	1151.59	30.48
WRH98181	6161371.98	549131.16	1144.56	26.07
WRH96182	6161368.45	549151.28	1143.39	30.48
WRH96183	6181407.75	549480.25	1098.74	30.48
WRH96184	6161083.99	549575.24	1086.20	30.48
WRH96185	6161367.98	549172.75	1142.27	30.48
WRH96186	6161942.28	549575.89	1078.68	18.10

**1996 Drill Hole Collar  
Survey Summary  
NAD27 UTM**

<b>Drillhole</b>	<b>Northing (m)</b>	<b>Easting (m)</b>	<b>Elevation (m)</b>	<b>Depth (m)</b>
WRH96187	6161860.32	549623.32	1078.92	30.48
WRH96188	6161876.56	549607.74	1078.51	30.48
WRH96189	6161891.47	549595.68	1077.84	18.30
WRH96190	6161492.88	549635.11	1081.63	26.10
WRH96191	6161478.13	549650.12	1078.34	30.00
WRH96192	6161462.92	549670.93	1073.90	30.00
WRH96193	6160904.46	548790.78	1123.66	12.19
WRti96194	6160767.79	548957.06	1203.89	30.48
WRH96195	6160767.79	548957.06	1190.44	32.00
WRH96196	6160807.62	548913.40	1117.95	30.48
WRH96197	6180757.63	548986.16	1114.49	30.48
WRH96198	6160766.25	548976.60	1115.16	30.48
WRH96199	6160891.77	548805.39	1123.90	30.48
WRH96200C	6162076.13	549189.06	1131.20	20.27
WRH96201 C	6162280.79	549466.99	1119.40	36.58
WRH98203	6161725.62	550217.92	1076.73	31.09
WRH98204	6161515.18	550297.12	1039.95	19.20
WRH96205	6161771.04	550191.44	1079.37	38.00
WRH96206C	8162007.33	549965.90	1108.32	43.89
WRH96207C	6162222.66	549562.38	1113.53	22.56
WRH96208	6162231.03	549554.70	1113.07	19.20
WRH96209C	6162278.44	549468.86	1119.41	65.53
WRH98210	6161743.64	550209.54	1077.44	38.10
WRH96211 C	8162127.96	549959.15	1109.61	25.60
WRH96212C	6164441.33	550807.02	674.50	37.19
WRH96213C	6164529.62	550591.17	691.22	80.77
WRH96214C	6164367.10	550517.16	706.27	27.00
WRH96215C	6164226.85	551192.70	641.21	38.40
WRH96216C	6164226.07	551193.07	641.17	18.29
WRH96217	6160914.07	548484.50	1149.83	30.48
WRH96218	6160976.31	548710.34	1130.69	27.43
WRH96219	6160995.43	548692.03	1127.72	18.29
WRH96220	6161018.90	548654.28	1137.53	30.48
WRH96221	6161002.14	548607.95	1143.43	15.24
WRH96221 B	6163592.40	550426.39	825.82	30.48
WRH96222	6163547.46	550468.60	818.60	30.48
WRH96223	6163561.55	550454.38	820.78	30.48
WRH96224	6163578.03	550440.83	823.14	30.48
WRH96225	6161077.28	549622.65	1083.90	24.38
WRH96226	6161069.59	549653.80	1079.62	17.05
WRH96227	6161402.29	549486.09	1098.74	30.48
WRH96228	6161293.68	549405.24	1107.86	30.48
WRH96229	6181748.02	549185.71	1139.84	30.48
WRH96230	6161619.74	549103.17	1149.33	24.00
WRH96231	8161595.15	549946.24	1049.65	21.34
WRH96232	6160888.21	549996.67	1041.95	24.38

**1996 Drill Hole Collar  
Survey Summary  
NAD27 UTM**

<b>Drillhole</b>	<b>Northing (m)</b>	<b>Easting (m)</b>	<b>Elevation (m)</b>	<b>Depth (m)</b>
WRH96233	6161530.57	550705.12	906.33	18.29
WRH96234	6163303.09	550798.76	821.47	30.48
WRH96235	6163312.62	550784.35	821.34	30.48
WRH96236	6163357.63	550681.62	819.36	30.48
WRH96237	6163395.33	550636.75	815.13	21.34
WRH96238	6163409.91	550615.60	809.62	29.00
WRH96243	6164276.43	551086.15	654.64	18.29

## **APPENDIX 1.2**

### **Drillhole Summaries**

**1996 Drill Core  
Sample Intervals  
(metres)**

Drillhole ID	Sample ID	Sample Interval	
		From	To
WRH96004C	97301	38.45	- 39.85
WRH96004C	97323	39.85	- 40.55
WRH96004C	97302	40.55	- 41.05
WRH96004C	97303	44.36	- 44.70
WRH96004C	97304	44.70	- 45.01
WRH96004C	97305	45.01	- 45.17
WRH96004C	97306	45.17	- 45.62
WRH96004C	97307	45.62	- 46.06
WRH96004C	97308	46.06	- 46.50
WRH96004C	97309	46.50	- 46.95
WRH96004C	97310	46.95	- 47.26
WRH96004C	97311	47.26	- 47.56
WRH96004C	97312	50.55	- 51.05
WRH96004C	97313	52.15	- 52.55
WRH96004C	97314	52.55	- 53.90
WRH96004C	97315	53.90	- 55.20
WRH96004C	97316	55.20	- 55.70
WRH96010C	97317	34.55	- 36.49
WRH96010C	97318	36.49	- 38.30
WRH96010C	97319	38.30	- 39.66
WRH9601 OC	97320	40.00	- 40.21
WRH9601 OC	97321	40.21	- 41.60
WRH96010C	97322	41.60	- 41.80
WRH96024C	97330	24.54	- 24.70
WRH96024C	97331	24.70	- 26.48
WRH96024C	97332	26.48	- 28.75
WRH96024C	97333	28.75	- 26.94
WRH96025C	97325	28.06	- 28.15
WRH96025C	97324	28.15	- 29.10
WRH96025C	97326	29.10	- 29.39
WRH96025C	97328	30.58	- 30.70
WRH96025C	97327	30.70	- 32.10
WRH96025C	9732s	32.10	- 32.18
WRH96026C	97736	16.78	- 16.89
WRH96026C	97337	16.89	- 18.02
WRH96026C	97338	18.02	- 20.14
WRH96026C	9733s	20.14	- 20.24
WRH96070C	97352	12.66	- 12.86
WRH96070C	97351	12.86	- 13.70
WRH96070C	97353	13.70	- 13.95
WRH96070C	97358	16.11	- 16.28
WRH96070C	97354	16.28	- 16.92
WRH96070C	97355	16.92	- 17.17
WRH96070C	97356	17.17	- 17.50
WRH96070C	97357	17.50	- 17.65
WRH96070C	97361	24.31	- 24.66

**1996 Drill Core  
Sample Intervals  
(metres)**

<b>Drillhole ID</b>	<b>Sample ID</b>	<b>Sample From</b>	<b>Interval To</b>
WRH96070C	97359	24.66	- 26.00
WRH96070C	97360	26.00	- 26.18
WRH96072C	97364	41.75	- 41.85
WRH96072C	97362	41.85	- 42.95
WRH96072C	97365	42.95	- 43.12
WRH96072C	97366	44.64	- 44.80
WRH96072C	97363	44.80	- 45.97
WRH96072C	97367	45.97	- 46.12
WRH96072C	97368	50.10	- 52.10
WRH96072C	97369	52.10	- 52.30
WRH96072C	97374	52.90	- 53.00
WRH96072C	97370	53.00	- 54.07
WRH96072C	97371	54.07	- 54.47
WRH96072C	97372	54.47	- 55.00
WRH96072C	97373	55.00	- 55.13
WRH96073C	PV97376	45.05	- 46.05
WRH96073C	PV97377	46.05	- 46.22
WRH96073C	PV97378	47.36	- 47.55
WRH96073C	PV97379	47.55	- 48.70
WRH96073C	PV97380	48.70	- 49.15
WRH96073C	PV97381	52.26	- 52.46
WRH96073C	PV97382	52.46	- 54.65
WRH96073C	PV97383	54.65	- 54.80
WRH96073C	PV97384	54.80	- 55.40
WRH96073C	PV97385	55.40	- 56.43
WRH96073C	PV97386	56.43	- 56.83
WRH96073C	PV97387	56.83	- 57.30
WRH96073C	PV97388	57.30	- 57.50
WRH96074C	97271	21.62	- 23.15
WRH96074C	97272	24.14	- 24.80
WRH96074C	97273	24.80	- 24.95
WRH96075C	97251	20.24	- 20.45
WRH96075C	97252	20.45	- 21.50
WRH96075C	97253	21.50	- 22.10
WRH96075C	97254	22.10	- 22.85
WRH96075C	97255	22.85	- 23.02
WRH96075C	97256	23.02	- 23.53
WRH96075C	97257	23.53	- 25.55
WRH96075C	97258	25.55	- 26.01
WRH96075C	97259	26.01	- 26.49
WRH96076C	97260	21.30	- 22.47
WRH96076C	97261	22.47	- 22.90
WRH96076C	97262	22.90	- 23.60
WRH96076C	97263	23.60	- 23.75
WRH96076C	97264	23.75	- 24.67
WRH96076C	97265	24.67	- 26.14
WRH96076C	97266	26.14	- 27.00



**1996 Drill Core  
Sample Intervals  
(metres)**

Drillhole ID	Sample ID	Sample Interval		
		From.	-	To
WRH96077C	97268	3.05	-	4.15
WRH96077C	97269	5.45	-	6.30
WRH96077C	97270	8.75	-	10.35
WRH96078C	PV97430	17.09	-	17.22
WRH96078C	PV97431	17.45	-	18.57
WRH96078C	PV97432	18.57	-	18.79
WRH96078C	PV97433	18.79	-	19.67
WRH96078C	PV97434	19.67	-	19.93
WRH96078C	PV97435	19.93	-	20.20
WRH96078C	PV97436	20.20	-	21.05
WRH96078C	PV97437	21.05	-	21.35
WRH96078C	PV97438	23.03	-	23.35
WRH96078C	PV97439	23.35	-	24.15
WRH96078C	PV97440	24.15	-	24.25
WRH96078C	PV97441	24.25	-	25.55
WRH96078C	PV97442	25.55	-	25.97
WRH96079C	PV97448	47.70	-	48.00
WRH96079C	PV97449	48.00	-	50.40
WRH96079C	PV97460	50.40	-	50.76
WRH96079C	PV97461	51.45	-	52.85
WRH961 00C	PV97403	12.00	-	12.34
WRH96100C	PV97400	12.34	-	13.01
WRH96100C	PV97401	13.01	-	13.23
WRH96100C	PV97402	13.23	-	14.28
WRH96100C	PV97404	14.28	-	14.46
WRH96100C	PV97411	20.80	-	21.15
WRH961 00C	PV97405	21.15	-	22.85
WRH96100C	PV97409	22.85	-	24.00
WRH96100C	PV97407	24.44	-	24.66
WRH96100C	PV97408	24.66	-	25.35
WRH96100C	PV97410	25.35	-	25.65
WRH96102C	PV97454	27.65	-	27.95
WRH96102C	PV97450	28.40	-	30.12
WRH96102C	PV97451	30.12	-	31.00
WRH96102C	PV97452	31.00	-	32.08
WRH96102C	PV97453	32.08	-	32.27
WRH96102C	PV97457	38.95	-	39.45
WRH96102C	PV97455	39.45	-	41.00
WRH96102C	PV97456	41.00	-	41.30
WRH96103C	PV97458	26.35	-	26.60
WRH96103C	PV97459	26.60	-	27.79
WRH96103C	PV97412	27.79	-	28.16
WRH96103C	PV97413	43.10	-	43.55
WRH96103C	PV97414	43.55	-	44.05
WRH96103C	PV97415	44.05	-	44.85
WRH96103C	PV97416	44.85	-	46.85
WRH96103C	PV97417	46.85	-	47.15

**1996 Drill Core  
Sample Intervals  
(metres)**

Drillhole ID	Sample ID	Sample Interval	
		From	To
WRH96104C	PV97419	13.65	- 13.85
WRH96104C	PV97420	13.85	- 15.05
WRH96104C	PV9742 1	15.05	- 15.25
WRH96105C	PV97422	19.80	- 20.00
WRH96105C	PV97423	20.00	- 21.40
WRH96105C	PV97424	21.40	- 21.76
WRH96105C	PV97425	33.00	- 33.82
WRH96105C	PV97426	33.82	- 34.55
WRH96105C	PV97427	34.55	- 35.52
WRH96105C	PV97428	35.52	- 37.75
WRH96105C	PV97429	37.75	- 38.15
WRH96107C	PV97443	53.64	- 54.00
WRH96107C	PV97444	54.00	- 55.65
WRH96107C	PV97445	55.65	- 55.90
WRH96107C	PV97447	55.90	- 56.20
WRH96107C	PV97446	56.20	- 57.48
WRH96108C	97285	16.71	- 17.45
WRH96108C	97286	18.70	- 19.30
WRH96108C	97287	19.30	- 19.91
WRH96108C	97288	19.91	- 20.68
WRH96108C	97290	21.15	- 21.33
WRH96108C	97289	21.33	- 22.55
WRH96108C	97291	23.80	- 24.00
WRH96108C	97292	24.00	- 24.11
WRH96108C	97293	24.11	- 24.79
WRH96108C	97294	24.79	- 24.97
WRH96109C	97295	14.46	- 14.60
WRH96109C	97296	17.18	- 17.38
WRH96109C	97297	17.38	- 17.74
WRH96109C	97298	17.74	- 18.65
WRH96109C	9729s	19.43	- 20.21
WRH96109C	PV97464	20.76	- 20.90
WRH96109C	PV97465	20.90	- 21.27
WRH96109C	PV97537	71.08	- 75.80
WRH96109C	PV97538	73.78	- 74.37
WRH96109C	PV97539	76.70	- 78.77
WRH961 10C	PV97540	16.05	- 16.20
WRH9611 0C	PV97541	16.20	- 17.60
WRH96110C	PV97542	17.60	- 19.20
WRH9611 0C	PV97543	19.20	- 19.35
WRH96111C	PV97481	19.35	- 19.51
WRH96111C	PV97482	19.51	- 20.12
WRH96111C	PV97483	20.12	- 20.73
WRH96111 C	PV97484	21.32	- 21.51
WRH96111C	PV97485	21.51	- 22.09
WRH96111C	PV97486	22.09	- 23.14
WRH96112C	97282	14.98	- 15.53

**1996 Drill Core  
Sample Intervals  
(metres)**

Drillhole ID	Sample ID	Sample Interval		
		From		TO
WRH96112C	97283	15.53	-	16.13
WRH96112C	97284	16.13	-	16.79
WRH96113C	97300	a.34	-	12.72
WRH96113C	97276	12.72	-	13.34
WRH96113C	97277	13.34	-	13.82
WRH96113C	97278	1 3.82	-	14.12
WRH96114C	97280	7.70	-	6.48
WRH96114C	97281	8.48	-	9.45
WRH96115C	PV97491	3.78	-	5.00
WRH96115C	PV97492	5.00	-	6.10
WRH96116C	PV97489	ii. 80	-	13.58
WRH96116C	PV97490	i 3.58	-	14.82
WRH96117C	PV97487	4.15	-	5.41
WRH961 17C	PV97488	5.41	-	6.10
WRH96118C	PV97526	26.00	-	28.00
WRH96118C	PV97527	28.00	-	29.60
WRH96118C	PV97528	29.60	-	29.80
WRH96119C	PV97521	26.32	-	26.52
WRH96119C	PV97520	26.52	-	30.66
WRH96119C	PvS7522	30.68	-	30.88
WRH96119C	PV97524	33.77	-	33.92
WRH96119C	PV97523	33.92	-	34.76
WRH96119C	PV97525	34.75	-	34.87
WRH96140C	PV97535	i 9.88	-	22.72
WRH96140C	PV97536	22.72	-	22.92
WRH96141C	PV97533	20.60	-	23.48
WRH96141C	PV97534	23.48	-	23.55
WRH96142C	PV97529	24.82	-	25.10
WRH96142C	PV97530	25.10	-	27.26
WRH96142C	PV97531	27.26	-	28.72
WRH96142C	PV97532	28.72	-	28.92
WRH96145C	PV97493	17.74	-	18.44
WRH96145C	PV97494	18.85	-	1 a.95
WRH96145C	PV97495	18.95	-	is. 83
WRH96145C	PV97496	i 9.83	-	20.80
WRH96145C	PV97497	20.80	-	21.34
WRH96145C	PV97498	21.34	-	21.46
WRH96146C	PV97499	12.40	-	13.15
WRH96146C	PV97500	13.15	-	13.30
WRH96146C	PV97501	13.93	-	14.03
WRH96146C	PV97502	14.03	-	i4. 23
WRH96146C	PV97503	14.41	-	15.23
WRH96146C	PV97504	15.23	-	15.38
WRH96147C	PV97467	29.40	-	29.70
WRH96147C	PV97468	30.80	-	31 .00
WRH96147C	PV97469	31.20	-	31.30
WRH96147C	PV97470	31.30	-	31.50

**1996 Drill Core  
Sample Intervals  
(metres)**

Drillhole ID	Sample ID	Sample From	Interval To
WRH96147C	PV97471	31.80	- 32.10
WRH96147C	PV97472	32.10	- 32.20
WRH96147C	PV97473	32.30	- 33.10
WRH96147C	PV97474	33.10	- 33.60
WRH96147C	PV97475	33.80	- 34.10
WRH96148C	PV97476	16.38	- 17.05
WRH96148C	PV97477	17.05	- 17.20
WRH96148C	PV97478	19.50	- 19.95
WRH96148C	PV97479	19.95	- 20.40
WRH96148C	PV97480	20.40	- 20.95
WRH96150C	PV97505	17.56	- 17.66
WRH96150C	PV97506	17.66	- 18.53
WRH96150C	PV97507	18.53	- 18.68
WRH96150C	PV97508	19.74	- 19.82
WRH96150C	PV97509	19.82	- 20.80
WRH96150C	PV97510	20.60	- 20.95
WRH96150C	PV97511	21.90	- 22.00
WRH96150C	PV97512	22.00	- 23.48
WRH96150C	PV97513	23.48	- 24.04
WRH96150C	PV97514	24.04	- 24.09
WRH96151 C	PV97515	19.60	- 19.80
WRH96151C	PV97516	19.80	- 20.40
WRH96151C	PV97517	20.97	- 21.35
WRH96151 C	PV97518	21.59	- 22.24
WRH96151 C	PV97519	22.24	- 22.47
WRH96152C	PV97510	16.75	- 16.90
WRH96152C	PV97511	16.90	- 17.81
WRH96152C	PV97512	17.81	- 18.12
WRH96200C	PV97550	15.89	- 17.76
WRH96200C	PV97551	17.76	- 19.09
WRH96200C	PV97552	19.09	- 19.40
WRH96200C	PV97553	19.40	- 19.60
WRH96201C	PV97558	20.10	- 20.18
WRH96201 C	PV97554	20.18	- 21.32
WRH96201 C	PV97555	21.32	- 21.80
WRH96201 C	PV97556	21.80	- 23.10
WRH96201 C	PV97557	23.10	- 23.40
WRH96206C	PV97570	29.76	- 30.74
WRH96206C	PV97574	30.74	- 31.89
WRH96206C	PV97571	31.89	- 34.25
WRH96206C	PV97572	34.25	- 35.6%
WRH96206C	PV97575	35.69	- 36.58
WRH96206C	PV97573	36.58	- 38.61
WRH96206C	PV97576	38.61	- 38.81
WRH96209C	PV97567	26.33	- 26.58
WRH96209C	PV97568	26.58	- 26.97
WRH96209C	PV97569	26.97	- 27.77

**'1996 Drill Core  
Sample Intervals  
(metres)**

Drillhole ID	Sample ID	Sample Interval		
		From'	To	
WRH96209C	PV97580	27.77	-	28.93
WRH96209C	PV97586	28.93	-	29.08
WRH96211 C	PV97581	15.56	-	16.98
WRH96212C	PV97563	16.60	-	16.80
WRH96212C	PV97577	16.80	-	19.75
WRH96212C	PV97579	19.75		20.76
WRH96212C	PV97578	20.76	-	21.76
WRH96212C	PV97562	21.76		21.96
WRH96212C	PV97565	30.09	-	30.50
WRH96212C	PV97566	30.50	-	30.80
WRH96212C	PV97564	30.80		31.52
WRH96214C	PV97586	23.35		25.60
WRH96215C	PV97590	16.88		18.20
WRH96215C	PV97591	18.20	-	18.31
WRH96215C	PV97593	30.05		30.80
WRH96215C	PV97595	30.80	-	31.80
WRH96215C	PV97594	31.80	-	34.05
WRH96216C	PV97598	16.73	-	16.93
WRH96216C	PV97597	16.93	-	17.97
WRH96216C	PV97599	18.20	-	18.40

**1996 Exploration Program  
Drillhole Summary  
Seam Intervals**

<b>Drillhole</b>	<b>Seam</b>	<b>From (m)</b>	<b>To (m)</b>
<b>WRH96001</b>	<b>OVB</b>	<b>0.00</b>	<b>1.90</b>
WRH96001	CL	21.55	22.05
WRH96001	1-o	25.25	26.30
<b>WRH96001</b>	<b>2-o</b>	<b>35.10</b>	<b>36.25</b>
WRH96001	2-2	36.60	36.60
WRH96001	CL	37.00	37.70
<b>WRH96001</b>	<b>3-O</b>	<b>40.05</b>	<b>44.30</b>
WRH96001	CS	64.05	64.45
WRH96001	4-1	66.15	66.95
WRH96001	4-o	68.70	71.00
WRH96001	4-2	73.40	73.60
WRH96002	<b>OVB</b>	<b>0.00</b>	<b>2.00</b>
<b>WRH96002</b>	<b>CL</b>	<b>20.00</b>	<b>20.30</b>
WRH96002	4-1	21.75	22.55
WRH96002	4-o	24.70	26.30
WRH96002	4-2	27.00	27.00
WRH96002	4-4	27.95	26.20
WRH96002	4-8	<b>40.10</b>	<b>40.40</b>
WRH96002	A-5	44.30	44.70
WRH96002	A-3	52.35	52.70
WRH96002	A-1	56.25	57.05
<b>WRH96002</b>	<b>A-01</b>	<b>60.90</b>	<b>61.25</b>
WRH96002	A-O	61.75	62.90
WRH96003	<b>OVB</b>	<b>0.00</b>	<b>0.30</b>
WRH96003	5-O	34.10	35.25
<b>WRH96003</b>	<b>5-2</b>	<b>35.45</b>	<b>36.25</b>
WRH96003	5-6	38.20	38.95
WRH96003	CL	39.55	40.00
WRH96003	6-O	52.35	53.55
WRH96003	6-2	53.60	54.50
WRH96003	CM	56.50	57.30
WRH96003	7-0.1	123.75	128.95
<b>WRH96004C</b>	<b>OVB</b>	<b>0.00</b>	<b>0.80</b>
<b>WRH96004C</b>	<b>A-1</b>	<b>5.65</b>	<b>6.50</b>
<b>WRH96004C</b>	<b>A-O</b>	<b>8.80</b>	<b>10.05</b>
<b>WRH96004C</b>	<b>C L</b>	<b>11.65</b>	<b>12.05</b>
<b>WRH96004C</b>	<b>MARKER</b>	<b>30.00</b>	<b>30.75</b>
<b>WRH96004C</b>	<b>5-o</b>	<b>36.45</b>	<b>39.25</b>
<b>WRH96004C</b>	<b>5-2</b>	<b>39.35</b>	<b>40.55</b>
<b>WRH96004C</b>	<b>5-6</b>	<b>44.70</b>	<b>46.50</b>
<b>WRH96004C</b>	<b>COAL</b>	<b>46.95</b>	<b>47.26</b>
<b>WRH96004C</b>	<b>6-3</b>	<b>50.55</b>	<b>51.05</b>
<b>WRH96004C</b>	<b>6-O</b>	<b>52.55</b>	<b>55.20</b>
<b>WRH96004C</b>	<b>7-1</b>	<b>77.60</b>	<b>77.95</b>

**1996 Exploration Program  
Drillhole Summary  
Seam Intervals**

<b>Drillhole</b>	<b>Seam</b>	<b>From (m)</b>	<b>To (m)</b>
WRH96004C	7-0.1	83.05	86.80
WRH96004C	7-0	86.90	88.80
WRH96004C	7-2.1	90.30	90.65
WRH96004C	7-2	91.15	92.55
WRH96004C	8-0	123.70	124.40
WRH96004C	8-2	124.85	125.65
WRH96005	OVB	0.00	2.00
WRH96005	7-1	18.85	19.40
WRH96005	7-0.1	23.25	25.55
WRH96005	FAULT	25.55	25.60
WRH96005	7-0.1	28.25	31.55
WRH96005	7-0	31.65	32.60
WRH96005	7-2.1	34.15	34.45
WRH96005	7-2	34.95	36.20
WRH96005	COAL	37.70	38.15
WRH96006	OVB	0.00	0.70
WRH96006	7-0.1	6.35	30.45
WRH96006	7-0	26.90	28.20
WRH96006	FAULT	28.50	28.60
WRH96006	7-0	28.85	30.45
WRH96006	7-2.1	31.55	31.95
WRH96006	7-2	32.40	34.05
WRH96007	OVB	0.00	0.30
WRH96007	7-1	10.20	10.85
WRH96007	7-0.1	15.10	20.70
WRH96007	7-0	20.90	24.25
WRH96007	7-2.1	25.60	25.90
WRH96007	7-0	26.65	30.00
WRH96007	FAULT	28.20	28.30
WRH96007	7-2	28.50	30.00
WRH96007	CL	31.45	31.80
WRH96008	OVB	0.00	0.80
WRH96008	7-1	13.10	13.40
WRH96008	7-0.1	24.60	25.80
WRH96008	7-1	27.90	28.30
WRH96008	FAULT	32.10	32.20
WRH96008	7-0.1	34.95	37.45
WRH96008	7-0	37.45	38.80
WRH96008	7-2.1	40.15	40.35
WRH96008	7-2	40.75	42.00
WRH96008	CS	53.05	53.30
WRH96009	OVB	0.00	0.50

**1996 Exploration Program  
Drillhole Summary  
Seam Intervals**

<b>Drillhole</b>	<b>Seam</b>	<b>From (m)</b>	<b>To (m)</b>
WRH96009	7-1	3.50	4.15
WRH96009	7-0	FO	8.80
WRH96009	7-1	25.25	25.85
WRH96009	CL	(7	40.30
WRH96010C	OVB	0.00	1.00
WRH96010C	7-1	12.60	13.50
WRH96010C	7-1	24.25	25.45
WRH96010C	7-0.1	34.55	36.75
WRH96010C	7-0	36.75	38.30
WRH96010C	7-2.1	39.65	39.95
WRH96010C	7-2	40.20	41.60
WRH96011	OVB	0.00	1.00
WRH96011	cs	11.20	11.45
WRH96011	cs	15.95	16.20
WRH96011	CS	17.50	17.75
WRH96011	cs	22.95	23.60
WRH96011	cs	35.75	36.00
WRH96011	cs	41.95	42.30
WRH96011	cs	43.05	43.40
WRH96011	cs	47.25	47.65
WRH96012	HG12	11.00	11.25
WRH96012	2-2	11.35	12.35
WRH96012	2-0	14.50	14.90
WRH96012	3-1	19.50	19.90
WRH96012	3-0	21.30	22.95
WRH96012	4-5	43.05	43.60
WRH96012	4-3	46.50	48.79
WRH96012	4-1	48.20	48.40
WRH96012	4-0	52.45	53.00
WRH96013	CL	14.95	15.45
WRH96013	cs	19.55	19.80
WRH96013	CL	31.45	32.05
WRH96013	Flt	38.80	38.85
WRH96013	CL	43.15	43.70
WRH96013	A-1.1	63.18	64.15
WRH96013	A-1	84.40	65.20
WRH96013	A-0	65.62	67.00
WRH96013	ShA5	81.20	83.45
WRH96014	1-0	HA	25.20
WRH96014	2-2	33.20	33.55
WRH96014	2-0	34.80	35.70
WRH96014	3-3	37.80	38.10



**1996 Exploration Program  
Drillhole Summary  
Seam Intervals**

<b>Drillhole</b>	<b>Seam</b>	<b>From (m)</b>	<b>To (m)</b>
WRH96014	3-1	38.90	39.47
WRH96014	3-0	41.00	42.80
WRH96014	HG34	48.00	48.20
WRH96015	A-0	7.60	8.55
WRH96015	A-1	9.90	11.50
WRH96015	<b>SHA5</b>	22.70	25.60
WRH96015	<b>HGA5</b>	45.30	45.70
WRH96015	6-5	75.60	76.00
WRH96015	6-3	77.55	77.75
WRH96015	8-0	82.70	83.85
WRH96015	6-6	91.80	92.45
WRH96015	6-8	94.30	94.65
WRH96016	<b>OVB</b>	0.00	0.75
WRH96016	A-3.0	3.95	4.55
<b>WRH96016</b>	A-1	14.95	15.55
WRH96016	A-0	17.90	19.22
WRH96016	<b>Sha5</b>	31.00	32.80
WRH96016	HGA5	44.60	46.80
WRH96016	A-5.1	49.23	49.41
WRH96016	A-5	50.40	51.35
WRH96017	<b>A-3.0</b>	5.60	5.85
WRH96017	A-3.2	8.70	8.90
WRH96017	A-1	22.60	23.55
WRH96017	A-0	24.65	28.05
WRH96017	<b>Sha5</b>	36.00	37.70
WRH96017	<b>HGA5</b>	52.50	52.80
WRH96018	BD-4	11.30	12.20
<b>WRH96018</b>	1-11	22.40	22.60
WRH96018	cs	26.30	26.75
WRH96018	1-9	27.50	28.00
WRH96018	<b>1-7</b>	32.60	32.75
<b>WRH96018</b>	2-0	60.65	61.25
WRH96018	3-0	62.85	64.25
WRH96019	BD4	16.60	16.80
WRH96019	<b>HGB1U</b>	25.20	25.40
WRH96019	1-9	35.33	35.60
WRH96019	<b>HGB1L</b>	41.20	41.60
WRH96019	1-7	48.55	49.10
<b>WRH96019</b>	2-2	64.28	55.55
WRH96019	2-0	55.90	57.65
WRH96019	3-1	60.40	60.87
WRH98019	3-0	63.65	64.00

**1996 Exploration Program  
Drillhole Summary  
Seam Intervals**

<b>Drillhole</b>	<b>Seam</b>	<b>From (m)</b>	<b>To (m)</b>
WRH96019	HG34	72.00	72.30
WRH96019	3-4	73.30	73.50
WRH96019	3-6	74.70	75.30
WRH96020	A-1	8.05	8.97
WRH96020	A-2	10.40	10.95
WRH96020	5-5	34.50	35.50
WRH96020	5-3	37.00	37.55
WRH96020	6-3	51.30	54.55
WRH96020	5-0	51.55	52.10
WRH96020	6-0	59.70	61.80
WRH96021	OVB	0.00	0.60
WRH96021	7-1	19.60	20.60
WRH96021	75.1	24.60	32.60
WRH96021	7-0	32.70	35.50
WRH96021	7-2.1	38.15	39.00
WRH96021	7-2	41.65	44.25
WRH96022	OVB	0.00	0.30
WRH96022	7-0.1	7.65	13.45
WRH96022	7-0	13.60	15.50
WRH96022	7-2.1	16.70	17.30
WRH96022	7-2	18.20	20.30
WRH96023	OVB	0.00	2.50
WRH96023	5-0	32.85	33.65
WRH96023	5-2	33.85	34.20
WRH96023	5-8	35.55	36.80
WRH96024C	OVB	0.00	1.40
WRH96024C	CL	4.00	4.65
WRH96024C	15	8.05	10.90
WRH96024C	2-0	16.00	17.50
WRH96024C	2-2	18.50	18.50
WRH96024C	3-1	24.70	25.35
WRH96024C	3-0	25.39	28.75
WRH96025C	OVB	0.00	0.25
WRH96025C	3-OPL	0.25	2.50
WRH96025C	4-3	25.80	26.30
WRH96025C	4-1	28.13	29.10
WRH96025C	4-0	30.70	32.10
WRH96026C	OVB	0.00	1.50
WRH96026C	1-0	16.89	20.14

**1996 Exploration Program  
Drillhole Summary  
Seam Intervals**

<b>Drillhole</b>	<b>Seam</b>	<b>From (m)</b>	<b>To (m)</b>
WRH96027	OVB	0.00	1.00
WRH96027	cs	16.90	17.40
WRH96027	1-9	18.35	18.85
WRH96027	1-7	22.55	22.95
WRH96027	1-0	HI	34.10
<b>WRH96027</b>	2-0	47.20	47.95
WRH96027	2-2	48.30	50.10
<b>WRH96027</b>	3-1	52.16	52.65
WRH96027	3-0	54.30	56.90
<b>WRH96027</b>	HG34	65.00	65.20
WRH96027	4-5	75.55	76.35
WRH96027	cs	79.60	79.80
<b>WRH96027</b>	4-3	82.00	82.35
WRH96027	4-1	83.95	84.25
<b>WRH96027</b>	4-0	89.90	91.05
WRH96027	4-4	95.60	96.00
<b>WRH96028</b>	OVB	0.00	0.30
<b>WRH96028</b>	1-0	HI	5.95
WRH96028	2-0	20.55	20.90
<b>WRH96028</b>	2-2	21.70	22.90
WRH96028	3-1	24.90	25.45
<b>WRH96028</b>	3-0	27.40	29.45
WRH96029	OVB	0.00	2.80
<b>WRH96029</b>	7-0.1	27.70	32.65
<b>WRH96029</b>	7-0	32.65	32.65
<b>WRH96029</b>	7-2.1	32.95	33.05
<b>WRH96029</b>	7-2	33.85	35.50
WRH96029	CS	36.15	36.55
<b>WRH96030</b>	OVB	0.00	3.50
WRH96030	?	23.80	25.10
WRH96030	?	26.60	27.25
<b>WRH96031</b>	OVB	0.00	1.00
WRH96031	?	8.20	9.90
<b>WRH96031</b>	?	10.60	11.35
<b>WRH96032</b>	OVB	0.00	3.00
<b>WRH96032</b>	A-0	4.25	6.00
WRH96032	A-2	6.35	7.50
WRH96032	5-0	31.50	32.60
WRH96032	6-0	40.80	44.15
<b>WRH96032</b>	Flt	48.70	48.75
<b>WRH96032</b>	6-0	48.85	50.00
<b>WRH96032</b>	6-6	58.60	59.05
WRH96032	6-8	60.65	60.95
WRH96032	7-5	67.15	67.70

**4996 Exploration Program  
Drillhole Summary  
Seam Intervals**

<b>Drillhole</b>	<b>Seam</b>	<b>From (m)</b>	<b>To (m)</b>
<b>WRH96032</b>	<b>7-0.1</b>	<b>80.75</b>	<b>84.55</b>
WRH96032	CS	93.85	94.30
WRH96033	OVB	0.00	3.70
WRH96033	SHALE	3.70	53.30
WRH96033	BLUESK	53.30	54.60
WRH96033	BIRD	55.75	56.20
<b>WRH96033</b>	<b>BIRD</b>	<b>57.05</b>	<b>57.55</b>
WRH96033	CM	85.05	85.55
WRH96033	<b>CS</b>	<b>86.55</b>	<b>86.95</b>
WRH96033	CL	90.35	91.00
WRH96033	1-0	HI	101.55
WRH96033	2-0	114.15	114.75
WRH96033	2-2	115.05	116.50
WRH96034	OVB	0.00	2.20
WRH96034	SHALE	2.20	47.10
WRH96034	BLUESK	47.10	48.30
WRH96034	I-9	75.30	75.50
WRH96034	I-7	83.70	83.90
WRH96034	I-5	89.30	89.70
WRH96034	I-3	90.45	90.80
<b>WRH96034</b>	<b>I-0</b>	<b>98.05</b>	<b>95.60</b>
WRH96034	2-0	108.40	109.50
WRH96034	2-2	109.60	110.40
WRH96034	3-0	115.25	117.65
<b>WRH96034</b>	<b>HG33</b>	<b>125.40</b>	<b>125.60</b>
WRH96034	4-5	132.15	132.25
<b>WRH96034</b>	<b>4-3</b>	<b>134.20</b>	<b>134.60</b>
WRH96034	4-1	135.70	135.95
WRH96034	4-0	136.60	137.63
WRH96034	4-2	140.05	140.20
WRH96034	4-4	143.40	143.90
WRH96035	CL	28.10	29.85
<b>WRH96035</b>	<b>CL</b>	<b>30.35</b>	<b>31.05</b>
WRH96035	CL	31.00	34.15
WRH96035	<b>HGA5</b>	<b>62.00</b>	<b>62.50</b>
<b>WRH96035</b>	<b>5-5</b>	<b>76.95</b>	<b>78.30</b>
WRH96035	5-1	87.60	88.25
<b>WRH96035</b>	<b>5-0</b>	<b>88.70</b>	<b>89.85</b>
WRH96035	5-2	90.00	91.95
<b>WRH96035</b>	<b>5-4</b>	<b>94.00</b>	<b>94.50</b>
<b>WRH96035</b>	<b>5-6</b>	<b>97.15</b>	<b>97.50</b>
<b>WRH96035</b>	<b>5-10</b>	<b>99.80</b>	<b>100.00</b>
WRH96035	6-0	104.45	106.90
WRH96035	6-4	110.50	112.25

**1996 Exploration Program  
Drillhole Summary  
Seam Intervals**

<b>Drillhole</b>	<b>Seam</b>	<b>From (m)</b>	<b>To (m)</b>
WRH96035	6-6	115.68	116.00
WRH96035	HG67L	123.90	124.00
WRH96036	cs	13.50	13.65
WRH96036	cs	14.80	14.95
WRH96036	CL	26.28	26.48
WRH96036	CL	27.80	28.40
WRH96036	cs	36.85	37.25
WRH96036	HG?	38.60	38.70
WRH96037	cs	39.60	39.80
WRH96037	HGB1U	40.70	40.95
WRH96037	I-9	43.20	43.65
WRH96037	I-7	45.05	46.40
WRH96036	OVB	0.00	0.00
WRH96036	4-3?	6.45	7.40
WRH96038	4-1?	10.20	10.50
WRH96038	4-0	11.95	12.40
<b>WRH96038</b>	4-2	13.95	14.40
WRH96038	4-4	22.15	23.30
<b>WRH96038</b>	cs	26.40	26.85
WRH96039	OVB	0.00	3.00
WRH96039	CS	3.40	3.55
WRH96039	CS	5.85	6.25
<b>WRH96039</b>	CL	8.20	8.55
WRH96039	cs	9.90	10.10
<b>WRH96039</b>	CS	10.50	10.65
<b>WRH96039</b>	6-0	12.20	15.50
<b>WRH96040</b>	OVB	0.00	2.40
<b>WRH96040</b>	cs	10.20	10.55
WRH96040	cs	12.50	12.85
WRH96040	CL	20.00	20.70
<b>WRH96041</b>	OVB	0.00	2.90
<b>WRH96041</b>	A-4	15.30	15.50
WRH96041	5-1	40.37	40.80
WRH96041	5-0	41.45	42.00
WRH96041	6-3	64.52	55.90
<b>WRH96041</b>	6-0.3	61.65	61.95
<b>WRH96041</b>	6-0.1	62.45	62.85
<b>WRH96041</b>	6-0	63.32	64.85
<b>WRH96041</b>	6-2	67.60	68.15
<b>WRH96041</b>	6-4	74.80	75.90
<b>WRH96041</b>	CL	79.60	78.60

**1996 Exploration Program  
Drillhole Summary  
Seam Intervals**

<b>Drillhole</b>	<b>Seam</b>	<b>From (m)</b>	<b>To (m)</b>
WRH96041	CS	83.10	83.40
WRH96042	3-1	42.65	43.25
WRH96042	3-0	43.90	44.55
WRH96042	4-5	60.10	60.55
WRH96042	4-3	67.05	67.20
WRH96042	4-0	68.45	68.85
<b>WRH96042</b>	6-0	68.90	70.05
WRHG6042	cs	72.05	72.25
WRHG6042	4-8	79.60	80.40
<b>WRH96042</b>	CL	81.55	82.00
WRH96042	cs	84.50	84.80
WRHG6043	<b>HGB1L</b>	5.80	6.10
WRH96043	1-1	7.10	7.25
WRHG6043	1-0	7.65	8.70
<b>WRH96043</b>	2-0	21.80	22.65
WRH96043	2-2	23.60	25.50
<b>WRH96043</b>	3-1	27.05	27.50
WRHG6043	3-0	30.30	30.50
WRH96043	BLKSH	50.50	53.00
<b>WRH96043</b>	<b>4-0HA</b>	56.10	58.60
<b>WRH96043</b>	4-4	63.90	64.15
<b>WRH96043</b>	<b>4-8?</b>	69.25	70.50
<b>WRH96043</b>	CL	80.45	82.35
WRH96043	A?	89.25	GO.10
<b>WRH96044</b>	1-0	31.05	33.85
<b>WRH96044</b>	COAL	45.80	46.85
WRHG6044	COAL	49.10	53.60
<b>WRH96044</b>	COAL	62.00	62.85
<b>WRH96044</b>	COAL	66.70	67.15
WRH96044	COAL	67.60	68.10
WRHG6044	COAL	71.85	72.95
<b>WRH96044</b>	COAL	88.95	89.40
<b>WRH96044</b>	COAL	95.10	98.00
WRH96045	1-5	12.15	12.60
<b>WRH96045</b>	1-3	13.65	14.13
<b>WRH96045</b>	1-0	17.25	20.45
WRHG6045	2-0	35.05	37.22
WRH96045	2-2	37.35	38.50
<b>WRH96045</b>	3-0	42.20	<b>45.35</b>
WRH96045	FLT	61.00	61.10
WRH96045	4-4	67.90	68.15
WRH96045	4-8	75.30	75.50
<b>WRH96045</b>	CS	79.20	79.50

**1996 Exploration Program  
Drillhole Summary  
Seam Intervals**

<b>Drillhole</b>	<b>Seam</b>	<b>From (m)</b>	<b>To (m)</b>
WRH96046	OVB	0.00	2.60
<b>WRH96046</b>	1-0	9.65	12.75
WRH96046	2-0	25.40	26.15
<b>WRH96046</b>	2-2	26.55	27.80
WRH96046	3-1	38.20	38.75
<b>WRH96046</b>	3-0	38.75	40.60
WRH96046	3-0	46.90	52.85
<b>WRH96046</b>	<b>HG34</b>	64.40	64.50
WRH96046	CS	73.50	73.65
WRH96046	4-3	89.00	89.30
<b>WRH96046</b>	4-1	90.45	91.00
<b>WRH96046</b>	4-0	92.05	94.30
<b>WRH96046</b>	4-2	95.10	95.40
WRH96047	OVB	0.00	1.00
<b>WRH96047</b>	9-6	7.10	7.50
<b>WRH96047</b>	9-4	23.75	24.00
WRH96047	9-2	35.00	35.90
WRH96048	OVB	0.00	0.00
<b>WRH96049</b>	OVB	0.00	0.50
<b>WRH96049</b>	CL	2.75	3.40
WRH96049	7-0.1	22.05	27.50
WRH96049	7-0	27.50	27.50
WRH96049	7-2.1	27.80	28.25
<b>WRH96049</b>	7-2	28.85	30.60
WRH96049	CS	31.35	31.75
WRH96050	OVB	0.00	0.20
WRH96050	A-3R	5.50	6.15
WRH96050	A-I R	6.90	7.70
WRH96050	A-3	9.00	10.00
VVRH96050	A-I	10.35	11.50
WRH96051	OVB	0.00	0.50
<b>WRH96051</b>	A-3	3.10	4.05
WRH96051	A-I	4.45	5.40
WRH96051	A-0.1	10.90	11.20
WRH96051	A-O	11.30	12.20
WRH96051	A-2	13.35	13.80
WRH96052	OVB	0.00	1.10
WRH96052	A-0.1	1.40	1.70
WRH96052	A-O	1.80	3.30
WRH96052	A-2	4.40	4.95

**1996 Exploration Program  
Drillhole Summary  
Seam Intervals**

<b>Drillhole</b>	<b>Seam</b>	<b>From (m)</b>	<b>To (m)</b>
WRH96053	OVB	0.00	5.00
WRH96053	COAL	17.70	17.90
WRH96054	OVB	0.00	2.50
<b>WRH96054</b>	A-5	13.85	14.95
WRH96054	A-3	20.00	20.90
WRH96054	A-1	21.20	22.30
WRH96055	OVB	0.00	2.00
WRH96055	A-5	7.25	8.20
WRH96055	A-3	13.40	14.20
WRH96055	A-1	14.50	15.80
WRH96055	A-0.1	25.45	25.70
<b>WRH96055</b>	A-0	25.85	27.15
WRH96055	A-Z	28.70	29.50
WRH96056	OVB	0.00	2.00
WRH96056	A-5	13.40	14.50
WRH96056	A-3	19.90	20.50
WRH96056	A-1	20.70	21.45
WRH96056	A-0.1	25.18	25.70
<b>WRH96056</b>	A-0	25.80	26.80
WRH96056	A-2	27.70	28.25
WRH96057	OVB	0.00	2.50
WRH96057	A-5	12.45	13.25
WRH96057	A-3	19.80	20.60
WRH96057	A-1	21.00	22.20
<b>WRH96057</b>	A-0.1	28.55	28.85
WRH96057	A-0	28.85	30.55
WRH96057	A-2	31.15	31.70
WRH96058	OVB	0.00	0.30
WRH96058	A-5	2.50	3.20
WRH96058	A-3	6.45	7.20
WRH96058	A-1	7.45	8.45
WRH96058	A-0.1	14.05	14.40
WRH96058	A-0	14.55	15.55
WRH96058	A-2	15.95	16.80
WRH96059	OVB	0.00	1.70
WRH96059	A-7	7.50	8.15
<b>WRH96059</b>	A-5	22.50	22.75
WRH96059	A-3	27.70	28.40
WRH96059	A-1	29.10	30.15
WRH96059	FAULT	30.50	30.50



**1996 Exploration Program  
Drillhole Summary  
Seam Intervals**

<b>Drillhole</b>	<b>Seam</b>	<b>From (m)</b>	<b>To (m)</b>
WRH96059	A-1R	31.00	32.40
WRH96060	<b>OVB</b>	0.00	5.00
<b>WRH96061</b>	OVB	0.00	2.10
WRH96061	6-1	6.95	7.30
WRH96061	6-0	7.40	8.80
WRH96061	6-0.2	9.55	9.80
WRH96061	6-2.1	12.30	13.15
WRH96061	6-2	15.05	16.25
WRH96062	<b>OVB</b>	0.00	2.20
WRH96062	5-0	8.55	9.70
WRH96062	5-2	15.05	15.45
WRH96062	CS	16.75	17.00
WRH96062	<b>6-1</b>	22.10	22.45
WRH96062	6-0	22.75	24.45
WRH96062	<b>6-0.2</b>	24.80	25.00
WRH96062	6-2.1	27.50	28.30
WRH96062	6-2	30.20	31.40
WRH96063	<b>OVB</b>	0.00	0.10
WRH96063	h-0.1	7.30	8.10
WRH96063	A-0	8.35	10.90
WRH96063	A-2	11.15	<b>11.65</b>
WRH96064	<b>OVB</b>	0.00	0.20
WRH96064	A-5	5.20	6.00
WRH96064	A-3	10.70	11.70
WRH96064	A-1	12.05	13.20
WRH96064	A-0.1	27.75	28.35
WRH96064	A-0	28.70	30.35
WRH96084	A-2	30.55	31.15
<b>WRH96065</b>	OVB	0.00	1.80
WRH96065	A-3	8.25	9.55
<b>WRH96065</b>	A-1	9.85	11.05
WRH96065	A-0.1	17.65	18.25
WRH96065	A-0	18.40	19.40
WRH96065	A-2	19.90	20.70
WRH96066	<b>OVB</b>	0.00	2.00
WRH96066	A-0.1	6.40	7.15
WRH96066	A-0	7.40	8.60
<b>WRH96066</b>	A-2	9.30	10.15
WRH96067	OVB	0.00	0.40
WRH96067	4-3	5.70	6.10

**1996 Exploration Program  
Drillhole Summary  
Seam Intervals**

<b>Drillhole</b>	<b>Seam</b>	<b>From (m)</b>	<b>To (m)</b>
WRH96067	4-1.1	10.20	11.50
WRH96067	4-1	13.50	14.80
WRH96067	4-O	14.90	18.35
WRH96067	4-2	19.90	20.42
WRH96067	4-2.2	20.52	21.25
WRH96066	OVB	0.00	2.00
WRH96068	3-O	2.90	4.10
WRH96069	OVB	0.00	1.50
WRH96069	2-o	4.90	5.70
WRH96069	2-2	8.40	9.65
WRH96070C	OVB	0.00	0.20
WRH96070C	i-0	12.86	13.70
WRH96070C	2-2	16.28	17.62
WRH96070C	3-o	24.66	26.00
WRH96071	OVB	0.00	0.20
WRH96072C	OVB	0.00	1.20
WRH96072C	3-O	3.30	4.15
WRH96072C	4-3	36.10	36.65
WRH96072C	4-1.1	41.85	42.95
WRH96072C	4-1	44.80	45.97
WRH96072C	4-O	50.10	52.10
WRH96072C	4-2	53.00	54.05
WRH96072C	4-2.2	54.47	55.00
WRH96073C	OVB	0.00	1.00
WRH96073C	3-o	7.45	8.40
WRH96073C	4-3	39.32	39.80
WRH96073C	4-1.1	45.05	46.05
WRH96073C	4-1	47.55	48.70
WRH96073C	4-o	52.46	54.65
WRH96073C	4-2	55.40	56.45
WRH96074C	OVB	0.00	2.30
WRH96074C	1-5PTL	2.30	2.80
WRH96074C	1-3	12.50	13.70
WRH96074C	1-1	14.30	15.05
WRH96074C	1-o	15.25	17.80
WRH96074C	2-O	21.62	22.50
WRH96074C	22.65	23.15	
WRH96074C	2-2	24.14	25.42
WRH96074C	3-O	39.50	40.55

**1996 Exploration Program  
Drillhole Summary  
Seam Intervals**

<b>Drillhole</b>	<b>Seam</b>	<b>From (m)</b>	<b>To (m)</b>
WRH96075C	OVB	0.00	2.44
WRH96075C	I-5	9.90	11.25
WRH96075C	I-3	20.45	21.50
WRH96075C	I-1	22.10	22.85
WRH96075C	1 - O	23.02	25.55
WRH96075C	2-0	29.10	30.00
WRH96075C	2 - 2	31.55	32.60
WRH96076C	OVB	0.00	2.74
WRH96076C	I-5	11.20	12.40
WRH96076C	I-3	21.30	22.47
WRH96076C	I-1	22.90	23.60
WRH96076C	I-0	23.75	26.14
WRH96076C	I-OFLR	26.14	27.00
WRH96076C	2-0	29.60	30.55
WRH96076C	2-2	31.80	32.95
WRH96077C	OVB	0.00	1.52
WRH96077C	I-3	3.05	4.15
WRH96077C	I-1	4.85	6.30
WRH96077C	1 - O	8.75	10.35
WRH96077C	1-OFL	10.35	10.90
WRH96078C	OVB	0.00	3.05
WRH96078C	I - 3	17.46	18.57
WRH96078C	I-1	19.67	21.05
WRH96078C	I-0	23.30	25.55
WRH96078C	I-2	26.90	30.05
WRH96079C	OVB	0.00	1.83
WRH96079C	3-0	4.45	9.80
WRH96079C	4 - I .1	42.95	44.95
WRH96079C	4 - I	45.70	47.05
WRH96079C	4 - O	48.00	50.40
WRH96079C	4-2	51.45	52.40
WRH96079C	4 - 2 .2	52.40	52.85
WRH96079C	4 - 4	59.90	60.10
WRH96079C	4 - 8	66.00	66.20
WRH96080	OVB	0.00	0.40
WRH96080	COAL	4.60	5.35
WRH96080	I-3	6.10	6.70
WRH96080	I-1	8.30	9.63
WRH96080	I-0	9.76	11.60
WRH96080	1-OFL	11.60	12.60
WRH96080	2-O	20.90	21.70
WRH96080	CS	22.65	22.90

**1996 Exploration Program  
Drillhole Summary  
Seam Intervals**

<b>Drillhole</b>	<b>Seam</b>	<b>From (m)</b>	<b>To (m)</b>
WRH96080	2-2	24.70	25.75
WRHS6081	OVB	0.00	2.10
WRH96081	A-1	2.15	3.15
WRH96081	A-O.1	11.75	12.20
WRH96081	A-O	12.70	13.70
WRH96081	A-2	14.60	16.75
WRH96082	OVB	0.00	0.80
WRH96082	A-3	6.30	7.60
WRH96082	A-1	7.80	8.85
WRH96083	OVB	0.00	9.18
WRH96093	<b>OVB</b>	0.00	0.30
WRH96093	HGR	4.90	5.10
<b>WRH96093</b>	IO?	5.28	6.50
WRH96093	c s	8.50	8.60
WRH96093	HGR	8.80	8.95
WRH96093	HGR	12.30	12.70
WRH96094	OVB	0.00	0.30
WRH96094	8-O	7.15	8.95
<b>WRH96095</b>	OVB	0.00	0.70
WRH96095	7-0.1	10.20	11.25
WRH96095	7-o	12.25	13.15
WRH96095	7-2.1	14.15	14.80
WRH96095	7-2	14.85	15.80
<b>WRH96095</b>	7-2.2	16.20	16.90
WRH96095	<b>CS</b>	22.40	22.60
WRH96096	OVB	0.00	0.50
<b>WRH96096</b>	8-O	6.70	9.20
<b>WRH96098</b>	OVB	0.00	0.50
WRH96098	6-3	6.90	7.50
WRH96098	<b>6-1</b>	9.35	9.75
<b>WRH96098</b>	6-O	10.15	12.90
<b>WRH96099</b>	OVB	0.00	0.50
WRHS6099	<b>7-1</b>	9.25	10.00
WRH96099	7-0.1	10.25	11.90
WRH96099	7-o	12.05	12.75
WRH96099	7-2.1	13.50	13.80
<b>WRH96099</b>	7-2	13.90	15.45
<b>WRH96099</b>	7-2.2	15.85	16.15

**1996 Exploration Program  
Drillhole Summary  
Seam Intervals**

<b>Drillhole</b>	<b>Seam</b>	<b>From (m)</b>	<b>To (m)</b>
WRH96100C	OVB	0.00	0.91
WRH96100C	A-5	7.70	8.15
WRH961 OOC	A-3	12.34	13.07
WRH96100C	A-1	13.07	14.28
WRH96100C	A-O.1	19.80	20.50
WRH961 OOC	A-0	20.90	22.85
WRH961 OOC	A-2	24.00	25.35
WRH96101	OVB	0.00	1.90
WRH96101	A-7?	8.40	8.90
WRH96101	A-3	27.35	29.35
WRH96101	A-1	30.10	31.05
WRH96102C	OVB	0.00	1.90
WRH96102C	COAL	8.75	9.40
WRH96102C	A-3	28.40	30.12
WRH96102C	A-1	31.00	32.08
WRH96102C	A-O.1	38.85	39.30
WRH96102C	A-0	39.45	41.00
WRH96102C	A-2	42.20	42.50
WRH96103C	OVB	0.00	1.50
WRH96103C	5-0	26.60	27.79
WRH96103C	5-2	33.90	34.50
WRH96103C	6-1	43.60	44.05
WRH96103C	6-0	44.85	46.50
WRH96103C	6-0.2	46.55	46.85
WRH96103C	6-2.1	49.40	49.45
WRH96103C	6-2	51.35	52.20
WRH96104C	OVB	0.00	1.00
WRH96104C	6 - 4	13.85	15.05
WRH96105C	OVB	0.00	0.50
WRH96105C	COAL	1.20	1.75
WRH96105C	7-2.1	16.46	16.85
WRH96105C	7-2	20.00	21.40
WRH96105C	8-1	33.82	34.55
WRH96105C	8-0	35.52	37.75
WRH96106	OVB	0.00	12.00
WRH96106	3-4	3.10	3.20
WRH96106	3-8	21.70	21.90
WRH96106	4-3	40.00	40.00
WRH96106	4-1.1	45.20	46.55
WRH96106	4-1	46.85	47.25
WRH96106	4-O	47.95	49.60

**1996 Exploration Program  
Drillhole Summary  
Seam Intervals**

<b>Drillhole</b>	<b>Seam</b>	<b>From (m)</b>	<b>To (m)</b>
WRH96106	4-2	50.70	51.75
WRH96106	4-2.2	51.75	52.45
WRH96106	4 - 4	57.25	57.40
WRH96107C	OVB	0.00	0.50
WRH96107C	2-2	5.15	5.90
WRH96107C	3-0	21.10	22.50
WRH96107C	3 - 4	26.30	26.40
WRH96107C	3-8	33.20	33.40
WRH96107C	4-1.1	54.00	55.65
WRH96107C	4 - 1	56.20	57.48
WRH96107C	4-0	58.41	60.53
WRH96107C	4-2	61.70	62.60
WRH96107C	4-2.2	62.70	63.15
WRH96108C	OVB	0.00	1.00
WRH96108C	7-1	16.58	17.45
WRH96108C	7-0.1	18.70	20.95
WRH96108C	7-0	21.10	22.55
WRH96108C	7-2.1	23.65	23.90
WRH96108C	7-2	24.05	25.95
WRH96108C	C S	26.15	26.40
WRH96108C	C S	37.30	37.60
WRH96108C	C S	39.80	40.05
WRH96109C	OVB	0.00	1.30
WRH96109C	5-8PTL	1.30	1.85
WRH96109C	6-3	14.15	14.60
WRH96109C	6-1	16.00	16.35
WRH96109C	6-0	17.38	20.90
WRH96109C	C S	35.60	35.75
WRH96109C	C S	39.50	39.70
WRH96109C	C S	44.45	44.65
WRH96109C	7-1	67.84	69.50
WRH96109C	7-0.1	71.08	74.15
WRH96109C	7-0	74.50	75.80
WRH96109C	7-2.1	76.70	77.10
WRH96109C	7-2	77.30	78.77
WRH96109C	7-2.2	79.20	79.40
WRH961 10C	OVB	0.00	1.80
WRH961 10C	6-3	12.85	13.30
WRH9611 OC	6-1	14.70	15.05
WRH961 10C	6-0	16.20	19.20
WRH96111 C	OVB	0.00	0.90
WRH96111 C	CS	2.65	2.90

1996 Exploration Program  
Drillhole Summary  
Seam Intervals

Drillhole	Seam	From (m)	To (m)
WRH96111C	CS	15.05	15.30
WRH96111 C	CS	16.20	16.50
WRH96111C	8-0	19.51	22.46
WRH96112C	OVB	0.00	1.00
WRH96112C	4-3	11.15	11.35
WRH96112C	4-I	12.80	12.80
WRH96112C 4	- O	13.90	16.95
WRH96112C	4-2	17.70	18.00
WRH96113C	OVB	0.00	1.00
WRH96113C	4-3	7.90	8.20
WRH96113C	4-I	9.50	9.50
WRH96113C	4-o	10.50	14.12
WRH96114C	OVB	0.00	0.50
WRH96114C	4-3	3.40	3.60
WRH96114C	4-I	4.10	4.10
WRH96114C	4-o	5.85	9.45
WRH961 15C	OVB	0.00	1.50
WRH96115C	I-3	1.80	2.30
WRH96115C	I-I	3.15	3.28
WRH96115C	1-o	7.12	9.50
WRH96116C	OVB	0.00	1.80
WRH96116C I	- 3	6.50	6.85
WRH96116C	I-I	7.85	8.25
WRH96116C 1	- O	11.63	14.92
WRH96117C	OVB	0.00	1.80
WRH96117C 1	- O	2.30	6.10
WRH96118C	4-1.1	24.50	24.60
WRH96118C	4 - 1	25.50	25.70
WRH96118C	4-o	26.00	29.60
WRH96118C	4 - 0.2	30.24	30.75
WRH96118C	4-2	32.05	33.22
WRH961 18C	4-2.2	33.26	33.75
WRH96119C	OVB	0.00	3.00
WRH96119C	4-I	25.50	25.60
WRH96119C	4-0.1	26.52	26.80
WRH96119C	4-o	26.90	30.68
WRH96119C	4-2	33.92	34.75
WRH96120	OVB	0.00	6.00

**1996 Exploration Program  
Drillhole Summary  
Seam Intervals**

<b>Drillhole</b>	<b>Seam</b>	<b>From (m)</b>	<b>To (m)</b>
WRH96121	OVB	0.00	1.00
WRH96121	CL	10.50	10.90
<b>WRH96121</b>	4-1	11.80	12.55
WRH96121	4-o	14.50	16.85
<b>WRH96121</b>	4-2	18.55	19.35
WRH96122	OVB	0.00	3.50
WRH96122	3-1	6.10	6.45
WRH96122	3-0	6.85	9.00
WRH96123	OVB	0.00	1.00
WRH96123	2-2	8.85	9.75
WRH96124	OVB	0.00	0.05
WRH96124	2-2	1.20	2.40
WRH96125	OVB	0.00	0.90
WRH96125	2-2	1.00	2.20
WRH96125	CS	15.80	16.00
WRH96126	<b>OVB</b>	0.00	0.50
WRH96126	MARKER	6.70	8.30
WRH96126	CL	18.85	19.35
WRH96126	CL	20.70	21.30
WRH96126	1-o	26.15	28.70
WRH96127	OVB	0.00	1.80
WRH96127	COAL	5.85	6.10
WRH98127	COAL	7.25	7.80
WRH96127	1-Q	12.80	15.05
WRH96128	<b>OVB</b>	0.00	1.60
WRH96128	2-o	12.25	13.40
WRH96128	2-2	15.75	18.30
WRH96129	OVB	0.00	2.00
WRH96129	COAL	8.50	9.05
WRH96129	<b>COAL</b>	10.75	11.10
WRH96129	<b>1-0</b>	14.25	17.00
WRH96129	<b>2-0</b>	26.90	28.65
WRH96129	<b>2-2</b>	28.90	30.00
WRH96130	OVB	0.00	1.20
WRH96130	2-o	5.15	5.75
WRH96130	2-2	6.10	7.95
WRH96130	3-1	15.84	16.10
WRH96130	3-o	16.30	18.00
<b>WRH96130</b>	cs	21.60	21.75



**1996 Exploration Program  
Drillhole Summary  
Seam Intervals**

<b>Drillhole</b>	<b>Seam</b>	<b>From (m)</b>	<b>To (m)</b>
WRH96130	CS	24.40	24.55
WRH96130	CS	26.70	28.80
WRH96131	OVB	0.00	2.10
WRH96131	3-o	2.10	3.65
WRH96131	CS	6.55	6.70
WRH96131	CS	9.80	9.95
WRH96131	CS	12.80	12.90
WRH96132	OVB	0.00	0.50
WRH96132	CS	3.70	3.90
WRH96132	CS	19.00	19.15
WRH96132	CS	22.00	22.10
WRH96132A	OVB	0.00	1.00
WRH96132A	C-MARK	3.70	3.85
WRH96132A	C-MARK	19.05	19.30
WRH96132A	C-MARK	22.00	22.25
WRH96133	OVB	0.00	1.50
WRH96133	4-3	13.05	13.40
WRH96133	4-1	15.30	16.25
WRH96133	4-o	19.15	21.15
WRH96133	4-2	23.00	23.25
WRH96134	OVB	0.00	2.00
WRH96134	A-3	5.95	6.30
WRH96134	A-3?	6.55	6.83
WRH96134	A-1	10.90	11.00
WRH96134	A-O	20.30	20.40
WRH96134	A-O	22.05	22.90
WRH96134	A-O	23.75	23.95
WRH96135	OVB	0.00	0.80
WRH96135	6-0	1.50	15.30
WRH96136	OVB	0.00	0.50
WRH96136	cs	12.12	12.50
WRH96136	cs	19.20	19.42
WRH96136	cs	19.65	20.12
WRH96137	OVB	0.00	0.60
WRH96137A	OVB	0.00	2.40
WRH96137A	MARKER	19.35	19.75
WRH96137A	5-o	22.30	24.35
WRH96137A	5-2	24.70	24.90

**1996 Exploration Program  
Drillhole Summary  
Seam Intervals**

Drillhole	Seam	From (m)	To (m)
WRH96138	OVB	0.00	2.00
WRH96138	6-I	6.05	6.45
WRH96138	6-O	8.20	12.05
WRH96139	C-MARK	9.45	10.30
WRH96139	C-MARK	16.40	18.00
WRH96140C	OVB	0.00	1.00
WRH96140C	1-5	2.30	3.00
WRH96140C	C S	9.30	9.40
WRH96140C	C S	13.26	13.68
WRH96140C	1-3	14.85	15.35
WRH96140C	1 - O	19.88	22.72
WRH96140C	2-o	36.15	37.25
WRH96140C	2-2	38.30	39.45
WRH96141 C	OVB	0.00	1.00
WRH96141C	I-5	3.68	3.90
WRH96141C	C S	14.40	14.65
WRH96141C	I-3	15.55	16.05
WRH96141C	1-o	20.60	23.48
WRH96142C	OVB	0.00	1.00
WRH96142C	4 - 3	20.00	20.00
WRH96142C	4 - I	23.75	23.95
WRH96142C	4 - O	24.82	20.72
WRH96143	OVB	0.00	1.00
WRH96143	2-2	1.60	2.90
WRH96143	CL	20.60	21.40
WRH96143	4-I	56.68	56.92
WRH96143	4-o	57.80	69.50
WRH96143	CL?	70.00	70.60
WRH96143	4-2	72.25	73.05
WRH96144	OVB	0.00	2.50
WRH96144	5-0	13.55	14.95
WRH96144	5-2	15.35	16.15
WRH96145C	OVB	0.00	2.10
WRH96145C	C L	12.55	12.95
WRH96145C	C L	14.05	14.45
WRH96145C	1-o	17.74	21.34
WRH96146C	OVB	0.00	2.00
WRH96146C	2-o	11.95	13.15
WRH96146C	2-2	13.30	15.23

**1996 Exploration Program  
Drillhole Summary  
Seam Intervals**

<b>Drillhole</b>	<b>Seam</b>	<b>From (m)</b>	<b>To (m)</b>
WRH96147C	OVB	0.00	5.30
WRH96147C	2-1	5.50	5.75
WRH96147C	2-o	6.40	7.30
WRH96147C	2-2	7.65	8.75
WRH96147C	3-1	14.50	15.00
WRH96147C	3-o	15.46	17.75
WRH96147C	FAULT	28.00	28.01
WRH96147C	3-1	30.30	31.00
WRH96147C	3 - O	31.30	33.62
WRH96147C	C S	35.80	36.05
WRH96147C	C S	37.15	37.45
WRH96148C	OVB	0.00	1.20
WRH96148C	C S	14.95	15.25
WRH96148C	4-1	16.38	17.05
WRH96148C	4-o	19.25	22.80
WRH96149	OVB	0.00	2.80
WRH96149	5-0	19.00	20.15
WRH96149	5-2	20.60	20.65
WRH96150C	OVB	0.00	0.50
WRH96150C	7 - 0 . 1	17.24	18.53
WRH96150C	7-o	19.82	20.80
WRH96150C	7 - 2 . 1	22.00	22.70
WRH96150C	7-2	22.75	24.04
WRH96150C	7 - 2 . 2	24.50	24.70
WRH96150C	C S	31.80	32.15
WRH96151C	OVB	0.00	0.90
WRH96151C	5-o	19.80	20.97
WRH96151C	5-2	21.35	22.24
WRH96152C	OVB	0.00	1.00
WRH96152C	5-0	16.90	18.12
WRH96152C	5-2	18.50	19.49
WRH96153	OVB	0.00	1.00
WRH96153	CS	2.80	2.90
WRH96153	CS	5.90	6.05
WRH96153	8-3	13.80	14.60
WRH96153	8-0	21.75	24.35
WRH96154	OVB	0.00	1.50
WRH96154	2-2	0.48	9.47
WRH96154	3-o	27.63	28.70
WRH96154	4-1	60.90	61.13

**1996 Exploration Program  
Drillhole Summary  
Seam Intervals**

<b>Drillhole</b>	<b>Seam</b>	<b>From (m)</b>	<b>To (m)</b>
WRH96154	4-0	62.05	65.00
WRH96154	4-I R	67.30	65.00
WRH96154	4-0R	67.83	68.90
WRH96154	4-I R	70.20	70.50
WRH96154	4-0R	70.90	72.95
WRH96154	4-0.2	74.10	74.35
WRH96154	4-2	77.20	77.90
WRH96155	OVB	0.00	1.80
WRH96155	cs	20.60	20.80
WRH96155	cs	28.80	29.10
WRH96155	4-I	54.40	54.70
WRH96155	cs	57.55	57.90
WRH96155	4-o	59.15	61.70
WRH96155	4-2	65.00	65.35
WRH96155	CL	67.65	68.50
WRH96156	OVB	0.00	1.80
WRH96156	3-0PL	1.80	2.90
WRH96156	CL	6.55	7.12
WRH96156	4-3	24.00	24.00
WRH96156	4-I	24.82	25.00
WRH96156	4-0.1	28.90	29.15
WRH96156	4-o	29.30	32.88
WRH96156	cs	33.40	33.50
WRH96156	4-2	34.15	34.40
WRH96156	4-4	40.75	41.00
WRH96156	4-6	50.70	51.10
WRH96156	CL	52.35	52.65
WRH96156	cs	54.80	54.90
WRH96156	cs	55.25	55.45
WRH96156	cs	61.70	61.80
WRH96156	A?	68.67	69.62
WRH96157	OVB	0.00	3.70
WRH96157	3-0PL	3.70	4.00
WRH96157	cs	8.50	8.65
WRH96157	cs	10.35	10.55
WRH96157	FLT	28.00	28.30
WRH96157	FLT	31.00	31.20
WRH96157	cs	37.80	37.90
WRH96157	cs	39.40	39.50
WRH96157	4-3	51.65	51.90
WRH96157	4-I	53.28	53.63
WRH96157	4-o	55.40	57.25
WRH96157	4-0.2	57.38	57.80
WRH96157	4-2	58.78	59.00

**1996 Exploration Program  
Drillhole Summary  
Seam Intervals**

<b>Drillhole</b>	<b>Seam</b>	<b>From (m)</b>	<b>To (m)</b>
<b>WRH96158</b>	OVB	0.00	2.10
WRH96158	BSK	20.00	23.00
WRH96158	CL	32.45	32.98
WRH96158	cs	49.88	50.20
WRH96158	CS	60.00	60.33
<b>WRH96158</b>	cs	66.05	66.45
WRH96158	CL	67.35	68.00
WRH96158	1-o	70.00	73.00
WRH96158	cs	83.57	83.83
WRH96158	2-o	84.80	86.20
WRH96158	2-2	86.42	87.30
WRH96158	cs	90.60	90.80
WRH96158	3-l	93.50	93.50
WRH96158	3-a	93.75	94.90
WRH96158	4-3	115.00	115.30
WRH96158	4-l	116.45	116.80
WRH96159	OVB	0.00	3.00
<b>WRH96159</b>	cs	3.20	3.40
WRH98159	cs	18.80	18.90
<b>WRH96159</b>	cs	32.00	32.30
WRH96159	1-o	35.35	38.20
WRH96159	2-0	46.60	48.50
WRH96159	3-o	54.35	57.20
WRH96159	cs	59.70	59.80
WRH96159	cs	61.95	62.05
WRH96159	4-3	75.90	76.20
WRH96159	4-l	77.70	78.20
WRH96159	4-o	80.15	81.50
WRH96159	4-2	82.60	82.85
WRH96160	OVB	0.00	7.00
<b>WRH96160</b>	cs	6.58	6.90
WRH96160	9-o	7.50	8.70
WRH96160	CL-PL	17.75	18.00
WRH96161	OVB	0.00	6.50
<b>WRH96161</b>	9	8.50	10.90
<b>WRH96162</b>	OVB	0.00	0.00
WRH96163	OVB	0.00	1.50
WRH96163	MKA	7.05	7.15
WRH96163	7-1	15.29	16.00
WRH96163	7-o. 1	16.20	17.85
WRH96163	7-o	18.10	19.12

**1996 Exploration Program  
Drillhole Summary  
Seam Intervals**

<b>Drillhole</b>	<b>Seam</b>	<b>From (m)</b>	<b>To (m)</b>
WRH96163	7-2.1	19.95	20.25
WRH96163	7-2	20.40	21.65
WRH96164	OVB	0.00	1.00
<b>WRH96164</b>	MKB	7.80	8.50
WRH96164	<b>MKA</b>	10.70	10.85
WRH96164	7-1	20.00	20.70
WRH96164	7-0.1	20.90	22.55
<b>WRH96164</b>	7-0	22.80	23.80
WRH96164	7-2.1	24.65	24.95
<b>WRH96164</b>	7-2	25.10	26.35
<b>WRH96165</b>	OVB	0.00	0.50
<b>WRH96165</b>	CM66	1.50	1.80
<b>WRH96165</b>	CM67	14.45	14.70
<b>WRH96165</b>	MKB	26.75	28.30
WRH96166	OVB	0.00	0.30
WRH96166	<b>6-OPTL</b>	0.30	2.32
WRH96166	CM66	12.80	12.95
<b>WRH96166</b>	c s	18.00	18.20
WRH96166	c s	28.28	28.45
WRH96166	CM67	28.90	29.18
<b>WRH96166</b>	<b>CS</b>	29.70	29.82
WRH96167	OVB	0.00	0.00
<b>WRH96168</b>	OVB	0.00	1.00
<b>WRH96168</b>	5-2	1.50	3.80
<b>WRH96168</b>	c s	4.30	4.70
<b>WRH96168</b>	6-5	11.40	11.70
WRH96168	<b>6-1</b>	12.45	12.75
WRH96168	6-0	13.50	16.25
WRH96168	c s	18.50	18.70
WRH96168	<b>CS</b>	22.00	22.20
WRH96168	CMKR	26.55	26.65
<b>WRH96168</b>	CMKR	28.00	28.15
WRH96169	OVB	0.00	0.50
<b>WRH96169</b>	169	3.00	3.25
WRH96169	c s	6.95	7.20
WRH96169	CMKR	11.65	12.15
WRH96169	CMKR	13.40	13.70
WRH96169	<b>CM67</b>	19.70	20.05
<b>WRH96169B</b>	OVB	0.00	1.80
<b>WRH96169B</b>	7-1	16.65	17.15

**1996 Exploration Program  
Drillhole Summary  
Seam Intervals**

<b>Drillhole</b>	<b>Seam</b>	<b>From (m)</b>	<b>To (m)</b>
WRH96169B	7-0.1	20.05	24.00
WRH96169B	7-0	24.20	26.45
WRH96169B	7-2.1	27.45	29.95
WRH96169B	7-2	28.60	30.30
<b>WRH96170</b>	<b>OVB</b>	0.00	0.80
WRH96170	7-1?	10.45	11.10
WRH96170	7-0.1	15.85	20.80
WRH96170	7-0	20.90	22.25
WRH96170	7-2.1	23.90	24.25
WRH96170	7-2	24.85	26.40
WRH96171	OVB	0.00	0.90
<b>WRH96171</b>	<b>7-1?</b>	18.80	19.20
WRH96171	7-0.1	23.45	30.50
<b>WRH96171</b>	<b>7-0</b>	30.85	33.50
WRH96172	OVB	0.00	0.40
WRH96172	7-1	8.50	9.10
<b>WRH96172A</b>	<b>OVB</b>	0.00	1.00
WRH96173	OVB	0.00	0.90
<b>WRH96173</b>	<b>CL</b>	7.35	8.05
WRH96173	cs	14.50	14.70
<b>WRH96173</b>	<b>7-1?</b>	26.20	26.55
WRH96173	7-0.1	29.60	33.50
WRH96173	7-0	33.75	34.90
WRH96174	OVB	0.00	0.20
WRH96174	CL	2.70	3.40
<b>WRH96174</b>	<b>7-1</b>	18.70	19.05
WRH96174	7-0.1	22.05	26.00
WRH96174	7-a	26.20	27.30
WRH96174	7-2.1	28.60	28.90
WRH96174	7-2	29.50	30.90
WRH96175	OVB	0.00	2.00
WRH96175	CL	11.85	12.60
WRH96177	<b>OVB</b>	0.00	1.50
WRH96178	OVB	0.00	0.80
WRH96178	CL	1.25	2.25
WRH96179	OVB	0.00	0.90
WRH96179	5	1.65	3.65
<b>WRH96179</b>	<b>6-1</b>	12.75	48.15

**1996 Exploration Program  
Drillhole Summary  
Seam Intervals**

<b>Drillhole</b>	<b>Seam</b>	<b>From (m)</b>	<b>To (m)</b>
WRH96179	6-0	14.05	16.15
<b>WRH96180</b>	<b>OVB</b>	0.00	2.50
WRH98180	5-1	15.90	15.90
<b>WRH96180</b>	5-o	17.80	19.85
WRH96180	5-2	20.50	22.00
<b>WRH96180</b>	cs	22.55	<b>22.85</b>
WRH96180	6-5	27.15	45.00
<b>WRH96180</b>	6-3	29.30	30.00
WRH96181	OVB	0.00	0.60
WRH96181	<b>7-1M</b>	3.60	3.80
<b>WRH96181</b>	7-0.1	13.33	18.60
WRH96181	7-o	18.60	19.82
<b>WRH96181</b>	7-2.1	20.10	20.80
WRH98181	7-2	21.38	23.48
WRH96182	<b>OVB</b>	0.00	1.00
<b>WRH96182</b>	HGR	4.50	4.60
WRH96182	COAL	5.80	6.45
WRH96182	169	22.35	23.05
WRH96182	cs	27.38	27.68
WRH96183	<b>OVB</b>	0.00	2.10
<b>WRH96183</b>	5-0	2.90	4.13
WRH98183	5-2	4.80	5.25
WRH96183	5-a	17.55	17.80
WRH96183	6-1	22.50	22.90
WRH98183	6-0	25.30	29.30
WRH96184	<b>OVB</b>	0.00	1.00
<b>WRH96184</b>	7-1	13.30	13.70
WRH96184	7-o	17.50	22.55
WRH96184	7-2.1	24.05	24.35
WRH96184	7-2	24.90	26.30
<b>WRH96185</b>	<b>OVB</b>	0.00	1.50
WRH96185	cs	2.80	3.00
WRH96185	cs	10.80	10.95
<b>WRH96185</b>	7-1.1	25.10	25.65
WRH98185	7-01	26.15	26.50
WRH96186	<b>OVB</b>	0.00	0.40
WRH96186	cs	4.15	4.35
<b>WRH96186</b>	5-8	4.70	5.45
<b>WRH96186</b>	cs	8.15	8.25
WRH96186	6-3	11.20	11.60



**1996 Exploration Program  
Drillhole Summary  
Seam Intervals**

<b>Drillhole</b>	<b>Seam</b>	<b>From (m)</b>	<b>To (m)</b>
WRH96186	6-1	12.70	13.35
WRH96186	6-o	13.80	16.45
<b>WRH96187</b>	<b>OVB</b>	0.00	0.80
WRH96187	5-o	1.30	3.65
WRH96187	5-2	4.20	5.43
WRH96187	CS	10.18	11.20
WRH96187	<b>CS</b>	14.75	15.25
<b>WRH96187</b>	CL	18.55	19.13
<b>WRH96187</b>	5-8	20.70	22.32
WRH96188	OVB	0.00	1.00
WRH96188	5	1.20	2.75
<b>WRH96188</b>	CS	6.57	7.00
WRH96188	c s	8.35	8.70
WRH96188	5-8	9.32	9.66
WRH96188	6-5	19.08	19.78
WRH96188	6-3	22.00	22.40
WRH96188	6-1	23.35	24.62
WRH96188	<b>6-OPL</b>	25.30	26.50
WRH96189	OVB	0.00	3.65
WRH96189	COAL	6.40	7.30
WRH96189	COAL	9.75	10.65
WRH96189	COAL	11.60	12.20
WRH96190	OVB	0.00	2.00
WRH96190	7-1	4.70	5.60
WRH96190	7-0.1	13.30	18.20
WRH96190	7-o	18.40	20.25
<b>WRH96190</b>	7-2.1	21.10	21.70
WRH96190	7-2	21.90	23.95
WRH96191	<b>OVB</b>	0.00	2.00
WRH96191	HI	GAM	4.80
<b>WRH96191</b>	CS	16.20	16.40
<b>WRH96191</b>	c s	18.50	18.65
WRH96191	191	22.50	22.60
<b>WRH96192</b>	<b>OVB</b>	0.00	0.60
WRH96192	191	3.30	3.40
WRH96192	8-O	13.40	15.30
WRH96192	FAULT	15.50	15.60
WRH96192	8-O	17.60	19.95
<b>WRH96194</b>	<b>OVB</b>	0.00	0.50
WRH96194	COAL	2.85	3.75

**1996 Exploration Program  
Drillhole Summary  
Seam Intervals**

<b>Drillhole</b>	<b>Seam</b>	<b>From (m)</b>	<b>To (m)</b>
WRH96194	CM	18.80	20.15
WRH96194	CM	21.45	22.60
WRHS6195	OVB	0.00	1.00
WRH36195	c s	12.80	13.10
<b>WRH96195</b>	c s	14.30	14.60
WRH96195	c s	15.10	15.80
WRHQ6195	c s	20.90	21.20
WRH96195	s-3	29.20	30.60
WRH96198	OVB	0.00	1.10
WRH96196	s-3	8.45	11.00
WRH96196	CL	21.70	22.50
WRH96198	c s	26.40	26.70
WRH96197	<b>OVB</b>	0.00	0.80
WRH96197	SST	3.00	5.80
WRH96197	<b>s-o</b>	7.40	8.95
WRH96197	c s	11.70	11.90
WRH96197	c s	12.30	12.65
<b>WRH96197</b>	CS	12.95	13.15
WRH96197	c s	14.75	14.95
WRH96197	CL	22.80	23.50
WRHQ6198	OVB	0.00	0.50
WRH96198	c s	8.15	8.35
WRH96198	CL	15.85	16.85
WRH96198	c s	24.80	24.95
WRH98198	s-o	26.55	28.20
<b>WRH96200C</b>	OVB	0.00	1.50
<b>WRH96200C</b>	c s	10.50	10.95
<b>WRH96200C</b>	c s	11.90	12.40
<b>WRH96200C</b>	1-o	15.80	19.40
WRH96201 C	OVB	0.00	1.70
<b>WRH96201C</b>	2-o	20.18	21.32
WRH96201 C	2-2	21.80	23.10
WRH96201 C	3-1	26.90	27.75
WRH96201 C	3-o	28.16	30.30
<b>WRH96201C</b>	c s	33.60	33.90
WRH98201 C	c s	34.30	34.75
WRH96203	OVB	0.00	3.00
<b>WRH96203</b>	9.2	3.70	3.80
WRH98203	9-o	21.95	26.37

**1996 Exploration Program  
Drillhole Summary  
Seam intervals**

<b>Drillhole</b>	<b>Seam</b>	<b>From (m)</b>	<b>To (m)</b>
WRH96204	OVB	0.00	0.70
WRH96204 C	S	2.60	2.70
WRH96204	HGR	5.50	5.80
WRH96204	HGR	8.50	8.80
WRH96204	HGR	12.00	12.40
WRH96204	SCL	16.20	16.70
WRH96205	OVB	0.00	6.00
WRH96205	9-2	9.40	9.55
WRH96205	9-4	20.45	20.08
WRH96205	9-o	30.95	33.70
WRH96206C	OVB	0.00	1.90
WRH96206C C	S	3.85	4.10
WRH96206C	CS1	7.58	7.90
WRH96206C	7-1	29.76	30.74
WRH96206C	7-0.1	31.89	34.25
WRH96206C	7-o	34.40	35.69
WRH96206C	7-2.1	36.58	36.90
WRH96206C	7-2	37.05	38.68
WRH96206C	7-2.2	39.20	39.35
WRH96207C	OVB	0.00	1.00
WRH96207C	4-3	13.00	13.25
WRH96207C	4 - O	16.05	18.72
WRH96208	OVB	0.00	2.00
WRH96208	4-3	17.00	17.25
WRH96208	4-OPL	19.35	20.00
WRH96209C	OVB	0.00	2.10
WRH96209C	2 - O	18.70	20.00
WRH96209C	2-2	20.35	21.80
WRH96209C	3-1	25.55	25.88
WRH96209C	3-o	26.83	28.85
WRH96209C	4-o	55.00	59.55
WRH96209C	4-2	61.25	61.40
WRH96210	OVB	0.00	2.00
WRH96210 C	S	18.52	18.92
WRH96210	9-o	30.62	32.38
WRH96211C	OVB	0.00	0.70
WRH96211C	5-0	16.98	18.35
WRH96211 C	5-2	18.50	19.27
WRH96212C	OVB	0.00	1.50

**1996 Exploration Program  
Drillhole Summary  
Seam Intervals**

<b>Drillhole</b>	<b>Seam</b>	<b>From (m)</b>	<b>To (m)</b>
WRH96212C	A-3	16.80	19.75
WRH96212C	A-1	20.78	21.76
WRH96212C	A-0.1	29.70	30.15
WRH96212C	A-0	30.50	31.52
WRH96212C	A-2	32.60	33.40
WRH96213C	OVB	0.00	17.00
WRH96213C	I-5	29.00	29.85
WRH96213C	I-3	46.40	47.40
WRH96213C	I-1	49.55	50.40
WRH96213C	1-0	52.55	54.55
WRH96213C	I-2	56.45	58.90
WRH96213C	2-0	59.55	60.20
WRH96213C	3-0?	74.20	74.30
WRH96214C	OVB	0.00	1.50
WRH96214C	1-0	24.02	26.27
WRH96215C	OVB	0.00	0.70
WRH96215C	COAL	1.30	1.75
WRH96215C	7-2.1	13.10	13.75
WRH96215C	7-2	16.88	18.20
WRH96215C	6-1	30.05	30.80
WRH96215C	8-0	31.80	34.05
WRH96216C	OVB	0.00	1.00
WRH96216C	7-2.1	16.93	17.97
WRH96217	OVB	0.00	0.80
WRH96217	CS	8.75	9.35
WRH96217	cs	12.20	12.65
WRH96217	CL	23.15	24.00
WRH96218	OVB	0.00	0.30
WRH96218	A-5	3.85	4.25
WRH96218	A-3	13.75	14.50
WRH96218	A-1	14.85	15.40
WRH96218	A-0	16.05	17.00
WRH96218	A-2	17.15	17.85
WRH96219	OVB	0.00	0.30
WRH96219	CS	2.75	3.25
WRH96219	cs	4.35	4.75
WRH96219	?	11.65	13.60
WRH96220	OVB	0.00	0.40
WRH96220	CS	2.50	2.85

**1996 Exploration Program  
Drillhole Summary  
Seam Intervals**

<b>Drillhole</b>	<b>Seam</b>	<b>From (m)</b>	<b>To (m)</b>
WRH96220	CS	10.15	10.35
WRH96220	CS	11.50	12.30
WRH96220	CS	13.20	13.45
WRH96220	?	23.30	25.00
WRH96220	CS	25.85	26.25
WRH96221 B	OVB	0.00	0.40
WRH96221B	A-3	2.45	4.40
WRH96221 B	A-1	4.40	5.50
WRH96221 B	A-0.1	11.40	11.75
WRH96221 B	A-0	11.65	13.35
WRH96221B	A-2	14.55	15.10
WRH96222	OVB	0.00	0.80
WRH96222	A-5	5.00	5.65
WRH96222	A-3	12.35	12.95
WRH96222	A-1	13.15	14.35
WRH96222	A-0.1	19.35	19.70
WRH96222	A-0	19.80	21.05
WRH96222	A-2	21.60	22.25
WRH96223	OVB	0.00	0.70
WRH96223	A-5	5.80	6.55
WRH96223	A-3	12.85	13.50
WRH96223	A-1	13.80	15.00
WRH96223	A-0.2	20.15	20.40
WRH96223	A-0	20.40	21.70
WRH96223	A-2	22.40	23.05
WRH96224	OVB	0.00	0.90
WRH96224	A-3	8.25	8.95
WRH96224	A-1	9.20	10.40
WRH96224	A-0.1	16.15	16.15
WRH96224	A-2	18.30	19.10
WRH96225	OVB	0.00	1.00
WRH96225	7-1	7.10	7.40
WRH96225	7-0.1	12.10	15.75
WRH96225	7-0	16.10	17.15
WRH96225	7-2.1	19.65	20.00
WRH96225	7-2	20.35	21.80
WRH96226	OVB	0.00	1.00
WRH96226	7-0.1	6.15	10.10
WRH96226	7-0	10.40	11.45
WRH96226	7-2.1	13.90	14.20
WRH96226	7-2	14.85	16.25

**1996 Exploration Program  
Drillhole Summary  
Seam Intervals**

<b>Drillhole</b>	<b>Seam</b>	<b>From (m)</b>	<b>To (m)</b>
WRH96227	<b>OVB</b>	0.00	2.00
WRH96227	5-o	12.10	12.75
WRH96227	5-2	13.00	13.80
WRH96227	CS	15.15	15.45
WRH96227	6-l	20.90	21.40
WRH96227	6-0	23.10	25.45
WRH96226	<b>OVB</b>	0.00	2.40
WRH96228	6-l	11.05	11.75
WRH96228	6-0	13.75	17.85
WRH96228	c s	21.10	21.40
WRH96229	<b>OVB</b>	0.00	0.70
WRH96229	4-8	8.50	9.46
WRH96229	c s	15.00	15.20
WRH96229	<b>CS</b>	20.95	21.50
WRH96229	c s	21.65	22.25
WRH96230	<b>OVB</b>	0.00	0.70
WRH96230	c s	9.70	10.15
WRH96231	<b>OVB</b>	0.00	5.00
WRH96231	9-o	8.78	10.30
WRH96232	<b>OVB</b>	0.00	3.00
WRH96232	9-o	5.60	5.75
WRH96232	c s	7.85	7.95
WRH96232	1 0-0	11.35	11.83
WRH96232	11-0	15.00	15.30
WRH96232	c s	19.05	19.15
WRH96233	OVB	0.00	1.60
WRH96233	CL	7.35	8.00
WRH96233	CS	9.65	9.85
WRH96233	HGR	13.40	13.70
WRH96234	OVB	0.00	0.60
WRH96234	SST	6.70	10.40
WRH96234	9-o	19.30	20.30'
WRH96235	OVB	0.00	0.60
WRH96235	SST	18.30	20.90
WRH96236	OVB	0.00	1.00
WRH96236	7-3	12.75	13.75
WRH96236	701	23.95	24.80
WRH96236	<b>701P</b>	24.80	25.30

1996 Exploration Program  
Drillhole Summary  
Seam Intervals

Drillhole	Seam	From (m)	To (m)
WRH96236	70	25.30	25.85
WRH96237	OVB	0.00	0.25
WRH96237	58	0.25	0.95
WRH96237	60	10.85	11.50
WRH96237	602	13.95	14.20
WRH96238	OVB	0.00	0.20
WRH96238	CS	4.60	4.90
WRH96238	c s	7.50	7.70
WRH96238	50	6.15	9.60
WRH96238	52	10.20	11.05
WRH96238	c s	11.65	11.95
<b>WRH96238</b>	CS	13.00	13.30
WRH96236	58	16.30	17.10
WRH96238	60	26.75	27.45
WRH96243	OVB	0.00	2.20
WRH96243	A-O.1	9.75	10.35
WRH96243	A-O	10.70	11.95
WRH96243	A-2	11.30	11.75

## **APPENDIX 1.3**

### **Survey Control**



TEST HOLES			
STATION	NORTHING	EASTING	ELEVATION
WRH96001	6161775.2	550983.9	1156.0
WRH96002	6161733.6	550928.2	1154.0
WRH96003	6161555.6	550650.6	1123.5
WRH96004	6161756.1	550956.5	1153.7
WRH96005	6161386.3	550499.0	1122.9
WRH96006	6161362.6	550480.2	1121.4
WRH96007	6161369.5	550488.1	1121.5
WRH96008	6161368.7	550499.5	1123.0
WRH96009	6161366.8	550487.8	1121.4
WRH96010	6161385.8	550500.5	1123.1
WRH96011	6161110.3	551634.9	1170.0
WRH96012	6160688.2	551915.5	1183.2
WRH96013	6160559.9	551794.7	1172.4
WRH96014	6160715.2	551945.1	1182.1
WRH96015	6160325.6	551588.3	1169.1
WRH96016	6160227.9	551491.4	1164.6
WRH96017	6160357.8	551622.0	1170.6
WRH96018	6160773.5	551984.7	1187.4
WRH96019	6160118.9	552124.9	1197.4
WRH96020	6159411.3	552018.1	1136.4
WRH96021	6161261.1	550494.4	1110.7
WRH96022	6161199.9	550465.9	1102.9
WRH96023	6161574.0	550718.5	1134.5
WRH96024	6161440.1	550548.8	1131.1
WRH96025	6161738.2	550922.5	1154.0
WRH96026	6161758.5	550976.0	1154.3
WRH96027	6161076.4	551588.0	1168.1
WRH96028	6161024.4	551557.7	1164.8
WRH96029	6161008.4	551112.6	1123.6
WRH96030	6160948.2	551058.6	1125.9
WRH96031	6160925.9	551005.3	1118.5
WRH96032	6161050.2	551156.4	1131.5
WRH96037	6159393.9	552120.2	1138.8
WRH96041	6159028.6	552243.8	1118.3
WRH96042A	6159120.9	552604.5	1136.0
WRH96042	6159029.5	552509.1	1132.5
WRH96043	6159700.9	552327.8	1156.6
'A'	6161139.3	551787.7	1180.3
'B'	6160475.0	551731.2	1169.2

CONTROL SET			
STATION	NORTHING	EASTING	ELEVATION
IP '1'	6161109.04	551628.50	1170.01
IP '2'	6160774.74	551986.76	1187.12
IP '3'	6161568.24	550709.63	1134.25
IP '4'	6161552.34	550642.76	1123.23
IP '5'	6161434.99	550544.47	1131.15
IP '6'	6161351.07	550472.05	1120.16
IP '7'	6161242.87	550467.74	1105.72
IP '8'	6161281.58	550510.25	1113.88
IP '9'	6160985.81	551477.75	1156.72
IP '10'	6161000.20	551411.29	1150.56
IP '11'	6161104.41	551197.03	1135.15
IP '12'	6161039.74	551148.84	1129.93
IP '13'	6160979.00	551079.57	1123.68
IP '14'	6161087.95	551761.77	1181.05
IP '15'	6161142.29	551807.67	1183.25
IP '16'	6160875.54	551908.28	1181.05
IP '17'	6160544.96	551793.26	1172.76
IP '18'	6160345.48	551612.67	1170.55
IP '19'	6160303.83	551547.39	1171.16
IP '20'	6160572.58	552076.87	1202.85
IP '21'	6160493.63	552042.81	1209.88
IP '22'	6160268.74	552003.03	1222.53
IP '23'	6160345.86	552075.83	1224.46
IP '24'	6160084.06	552042.08	1197.16
IP '25'	6160059.61	552001.34	1196.89
IP '26'	6159990.98	552141.21	1182.48
IP '27'	6159908.18	552176.15	1174.12
IP '28'	6159769.31	552293.92	1161.11
IP '29'	6159676.82	552355.53	1155.59
IP '30'	6159473.94	552470.05	1148.86
IP '31'	6159419.10	552507.37	1150.74
IP '32'	6159261.60	552573.93	1142.23
IP '33'	6159114.39	552570.58	1142.39
IP '35'	6159945.69	551812.61	1170.54
IP '36'	6159843.39	551902.14	1161.94
IP '37'	6159444.20	552119.32	1141.74
IP '38'	6159349.22	552141.24	1136.11
IP '39'	6159012.84	552230.14	1118.84
IP '40'	6159255.46	552181.76	1123.72

CONTROL FOUND			
STATION	NORTHING	EASTING	ELEVATION
TH '4652'	6162092.93	550090.75	1112.53
IP '4653'	6162334.10	550316.19	1119.54
IP '4654'	6162498.81	550470.18	1163.28
TH '4708'	6161093.26	551645.41	1172.40
IP N 5+1 E 5+6	6162402.36	550243.18	1120.72
IP N 4+9 E 5+6	6162265.77	550389.23	1119.52
IP N 4+4 E 5+6	6161924.53	550754.32	1154.26
IP N 3+9 E 5+6	6161593.48	551119.67	1160.34
IP N 3+7 E 5+6	6161447.14	551265.90	1121.49
IP N 3+6 E 5+6	6161378.99	551338.98	1128.25
IP N 3+1 E 5+6	6161038.13	551704.53	1181.71
IP N 2+8 E 5+6	6160833.53	551923.77	1187.06
IP N 2+7 E 5+6	6160765.32	551996.85	1190.83

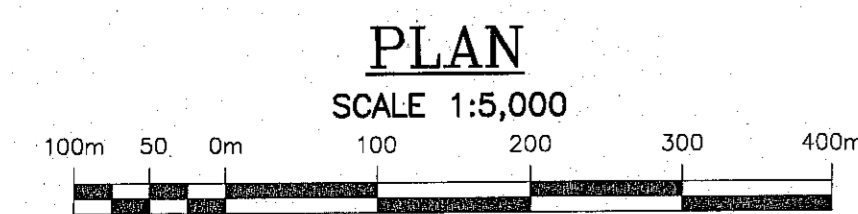
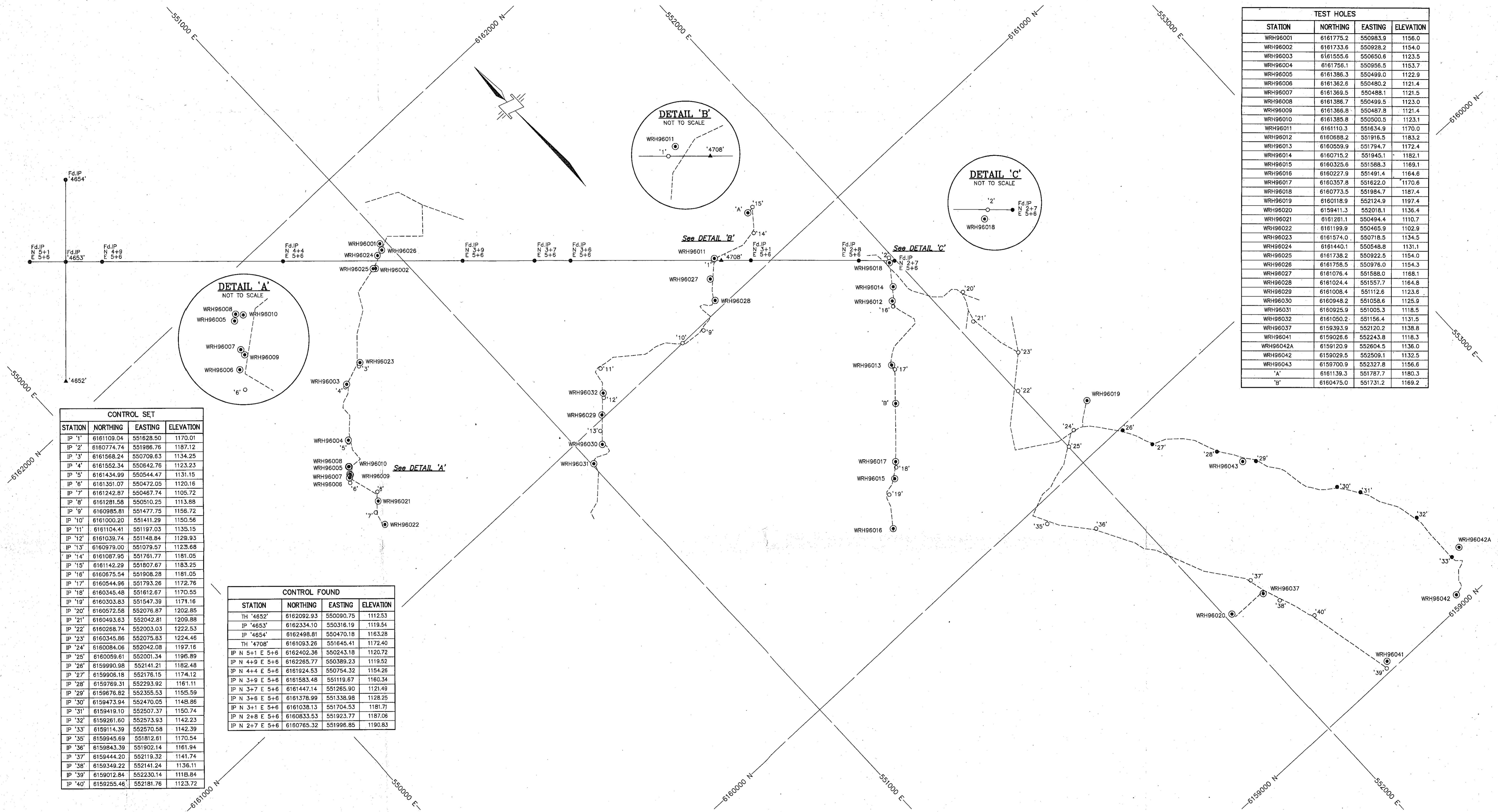
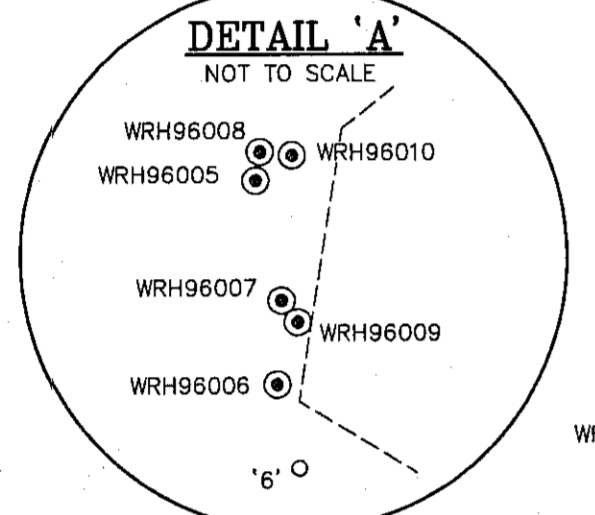
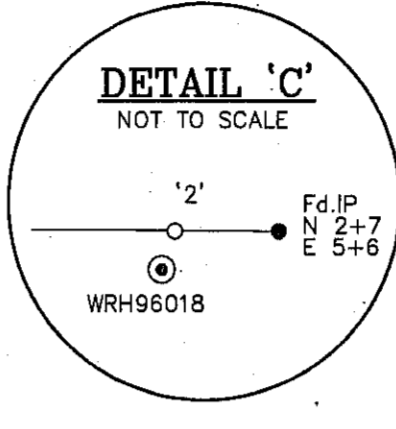
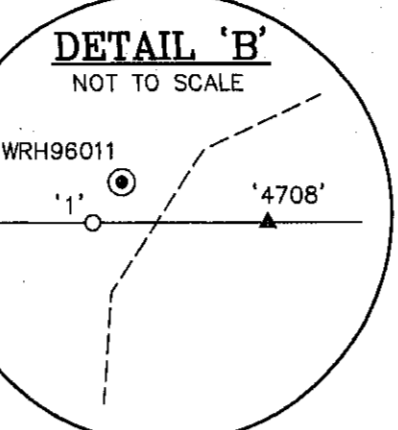

**NOTES :**  
 - NAD27 UTM coordinates are at sea level and were derived from selected control shown on McElhanney Drawing No. 076330 (July/August 1991).  
 - Found Control held fixed are TH '4653', TH '4654', TH '4652' & F.d.I.P. N 5+1 E 5+6; coordinates and elevations for all other found control points have been recomputed.  
 - Distances were reduced to Sea Level using a scale factor of 0.99963.  
 - Elevations shown are based on a geodetic datum. To calculate approximate ellipsoidal heights subtract 11.4m.

**LEGEND :**  
 ● DENOTES TEST HOLE  
 IP ○ DENOTES STANDARD IRON POST PLACED  
 F.d.I.P. ● DENOTES STANDARD IRON POST FOUND  
 ▲ DENOTES TRAVERSE HUB FOUND  
 --- DENOTES CENTERLINE ROAD/TRAIL

No.	REVISIONS	BY	DATE	CKD.

**PINE VALLEY COAL LTD.**

RE-ESTABLISHMENT OF SOUTH BASELINE, ESTABLISHMENT OF NEW CONTROL, LOCATION OF ROADS AND TEST HOLES. WILLOW CREEK COAL PROJECT 93-0-9

DATE : APRIL 3rd, 1996.      SCALE : 1:5,000      REV. NO.

**McElhanney ASSOCIATES**  
 PROFESSIONAL LAND SURVEYORS  
 Ste. 202, 10014-97th Ave.  
 Fort St. John, B.C.  
 Tel.: (604)787-0356, Fax: (604)787-0310

SHEET No. 1 OF 1  
 JOB No. 3111-04941  
 DWG. No. 4941P

**APPENDIX 2**  
**ANALYTICAL RESULTS**

**APPENDIX 2.1**  
**Raw Coal Analyses**



# Loring Laboratories Ltd.

629 Beaverdam Road N.E.,  
Calgary Alberta T2K 4W7  
Tel: 274-2777 Fax: 276-0641

TO : PINE VALLEY COAL  
ATTN : DAVID FAWCETT  
PROJECT : WILLOW CREEK

LLL FILE # : 3 8 4 7 9 - 2  
DATE : Oct 17, 1996  
REPORT BY : David Ko

F

## HEAD RAW

SAMPLE ID	-- Dry Basis --					FSI
	A.R. %H2O	A.D. %H2O	%ASH	%VOL	% F.C.	
<b>97430,32,33,37,38,42</b>	1.41	<b>1.05</b>	86.92			
<b>97431,34-36,39-41</b>	1.42	0.72	23.85	23.02	53.13	
37487	4.37	2.20	5.45	21.21	73.34	0.5
37488	1.48	<b>0.87</b>	1.36	25.16	73.48	8.5
97489	2.22	1.00	2.62	21.38	76.00	2.5
37432	3.85	0.92	0.98	27.37	71.65	8.5
<b>97537, 38</b>	5.69	0.91	15.76	14.04	70.20	0.0
97538	5.07	0.83	20.26	13.36	66.38	
<b>97554, 55, 57, 58</b>	4.15	0.99	43.56	16.48	39.96	
37553	4.20	0.86	9.42	18.82	71.76	2.0
<b>97567, 69, 80</b>	3.21	0.92	11.48	19.55	68.97	2.5
a7574 - 76	2.14	1.17	84.99			
97583.83	2.78	1.07	66.78	11.96	21.26	
97587	1.96	0.82	11.63	16.17	72.20	1.0
97590	2.43	0.77	10.01	13.66	76.34	0.5



# Loring Laboratories Ltd.

629 Beaverdam Road N.E.,

Calgary Alberta T2K 4W7

Tel: 274-2777 Fax: 276-0541

TO : PINE VALLEY COAL  
ATTN : DAVID FAWCETT  
PROJECT : WILLOW CREEK

LLL FILE # : 3 8 4 7 9 - 3  
DATE : Nov 13, 1996  
REPORT BY : David Ko

## HEAD RAW

SAMPLE ID	A.R.	A.D.	Dry Basis			% s
	%H2O	%H2O	% A S H	% VOL	% F.C.	
97568	5.06	1.19	80.47	--	0.13	
97581, 82	1.69	1.10	65.52	--	0.33	
97574, 75, 76	2.14	1.17	84.99	--	0.21	



# Loring Laboratories Ltd.

629 Beaverdam Road N.E.,  
Calgary Alberta T2K 4W7  
Tel: 274-2777 Fax: 275-0541

TO : PINE VALLEY COAL  
ATTN : DAVID FAWCETT  
PROJECT : WILLOW CREEK

LLL FILE # : 3 8 4 7 9  
DATE : Sept 17, 1996  
REPORT BY : David Ko

## ROCK

HOLE #	SAMPLE ID	A.R. %H2O	A.D. %H2O	D.B. % ASH	% s
RAW HEAD					
96103C	97458, 97412	1.04	0.62	86.33	0.15
96104C	97419, 97421	1.15	0.71	89.73	0.19



# Loring Laboratories Ltd.

626 Beaverdam Road N.E.,

Calgary Alberta T2K 4W7

Tel: 274-2777 Fax: 2760641

TO : PINE VALLEY COAL  
ATTN : DAVID FAWCETT  
PROJECT : WILLOW CREEK

LLL FILE # : 3 8 4 7 9  
DATE : Sept 17,199  
REPORT BY : . David Ko

ROCK

HOLE #	SAMPLE ID	A.R. %H2O	A.D. %H2O	D.B. % ASH	% s
<b>RAW HEAD</b>					
96105C	97422 , 97424	1.54	1.00	86.57	0.11
96147C	97475	4.90	1.22	86.39	0.07
96118C,96119C, 96142C	97528,97524, 97532	1.42	1.14	88.11	0.08

**APPENDIX 2.2**  
**Clean Coal Analyses**



APPENDIX 2.2 contains confidential data, as described in Section 2 of the *Coal Act Regulation*, and has been excluded from this report.

*Coal Act Regulation:* [http://www.qp.gov.bc.ca/statreg/reg/C/251\\_2004.htm](http://www.qp.gov.bc.ca/statreg/reg/C/251_2004.htm)

## **APPENDIX 2.3**

### **Float Sink & Size Analysis**

APPENDIX 2.3 contains confidential data, as described in Section 2 of the *Coal Act Regulation*, and has been excluded from this report.

*Coal Act Regulation:* [http://www.qp.gov.bc.ca/statreg/reg/C/251\\_2004.htm](http://www.qp.gov.bc.ca/statreg/reg/C/251_2004.htm)

## **APPENDIX 2.4**

### **Mineral Analysis**

APPENDIX 2.4 contains confidential data, as described in Section 2 of the *Coal Act Regulation*, and has been excluded from this report.

*Coal Act Regulation:* [http://www.qp.gov.bc.ca/statreg/reg/C/251\\_2004.htm](http://www.qp.gov.bc.ca/statreg/reg/C/251_2004.htm)

## **APPENDIX 2.5**

### **Ultimate Analysis**

APPENDIX 2.5 contains confidential data, as described in Section 2 of the *Coal Act Regulation*, and has been excluded from this report.

*Coal Act Regulation:* [http://www.qp.gov.bc.ca/statreg/reg/C/251\\_2004.htm](http://www.qp.gov.bc.ca/statreg/reg/C/251_2004.htm)

## **APPENDIX 2.6**

### **Ash Fusion Temperatures**



APPENDIX 2.6 contains confidential data, as described in Section 2 of the *Coal Act Regulation*, and has been excluded from this report.

*Coal Act Regulation:* [http://www.qp.gov.bc.ca/statreg/reg/C/251\\_2004.htm](http://www.qp.gov.bc.ca/statreg/reg/C/251_2004.htm)

## **APPENDIX 2.7**

**Miscellaneous**

APPENDIX 2.7 contains confidential data, as described in Section 2 of the *Coal Act Regulation*, and has been excluded from this report.

*Coal Act Regulation:* [http://www.qp.gov.bc.ca/statreg/reg/C/251\\_2004.htm](http://www.qp.gov.bc.ca/statreg/reg/C/251_2004.htm)

## **APPENDIX 2.8**

### **Petrography**

APPENDIX 2.8 contains confidential data, as described in Section 2 of the *Coal Act Regulation*, and has been excluded from this report.

*Coal Act Regulation:* [http://www.qp.gov.bc.ca/statreg/reg/C/251\\_2004.htm](http://www.qp.gov.bc.ca/statreg/reg/C/251_2004.htm)

861



## WILLOW CREEK COAL PROJECT

### 1996 COAL EXPLORATION PROGRAM

PINE RIVER AREA  
LIARD MINING DIVISION  
NTS 93 0/9  
NAD 27

Latitude: 55° 36' North  
Longitude: 122° 14' West

Owner :

Pine Valley Coal Ltd.

March 9, 1998

Submitted to :

The Ministry of Energy and Mines

# **APPENDIX 3      Geophysical Logs**

## *Volume 1*

Geophysical Logs WRH 96001  
Geophysical Logs WRH 96002  
Geophysical Logs WRH 96003  
Geophysical Logs WRH **96004C**  
Geophysical Logs WRH 96005  
Geophysical Logs WRH 96006  
Geophysical Logs WRH 96007  
Geophysical Logs WRH 96008  
Geophysical Logs WRH 9601 OC  
Geophysical Logs WRH 9601 1  
Geophysical Logs WRH 96012  
Geophysical Logs WRH 96013  
Geophysical Logs WRH 96013.1  
Geophysical Logs WRH 96014  
Geophysical Logs WRH 96015  
Geophysical Logs WRH 96015.1  
Geophysical Logs WRH 96018  
Geophysical Logs WRH 96019  
Geophysical Logs WRH 96020  
Geophysical Logs WRH 96022  
Geophysical Logs WRH 96023  
Geophysical Logs WRH **96024C**  
Geophysical Logs WRH **96025C**  
Geophysical Logs WRH 96027  
Geophysical Logs WRH 96028  
Geophysical Logs WRH 96029  
Geophysical Logs WRH 96030  
Geophysical Logs WRH 9603-I  
Geophysical Logs WRH 96032  
Geophysical Logs WRH 96033  
Geophysical Logs WRH 96034  
Geophysical Logs WRH 96035  
Geophysical Logs WRH 96036  
Geophysical Logs WRH 96037  
Geophysical Logs WRH 96038  
Geophysical Logs WRH 96039  
Geophysical Logs WRH 96040  
Geophysical Logs WRH 96041  
Geophysical Logs WRH 96042  
Geophysical Logs WRH 96042A  
Geophysical Logs WRH 96043  
Geophysical Logs WRH 96044  
Geophysical Logs WRH 96045  
Geophysical Logs WRH 96046  
Geophysical Logs WRH 96047  
Geophysical Logs WRH 96048  
Geophysical Logs WRH 96049  
Geophysical Logs WRH 96050





861



**WILLOW CREEK COAL PROJECT**

**1996 COAL EXPLORATION  
PROGRAM**

**PINE RIVER AREA  
LIARD MINING DIVISION  
NTS 93019  
NAD27**

Latitude: 55° 36' North  
Longitude: 122° 14' West.

Owner :

Pine Valley Coal Ltd.

March 9, 1998

Submitted to :

The Ministry of Energy and Mines

# APPENDIX3

# Geophysical Logs

## Volume 2

Geophysical Logs WRH 96051  
Geophysical Logs WRH 96052  
Geophysical Logs WRH 96053  
Geophysical Logs WRH 96054  
Geophysical Logs WRH 96055  
Geophysical Logs WRH 96056  
Geophysical Logs WRH 96057  
Geophysical Logs WRH 96058  
Geophysical Logs WRH 96059  
Geophysical Logs WRH 96060  
Geophysical Logs WRH 96061  
Geophysical Logs WRH 96062  
Geophysical Logs WRH 96063  
Geophysical Logs WRH 96064  
Geophysical Logs WRH 96065  
Geophysical Logs WRH 96066  
Geophysical Logs WRH 96067  
Geophysical Logs WRH 96068  
Geophysical Logs WRH 96069  
Geophysical Logs WRH **96070C**  
Geophysical Logs WRH **96072C**  
Geophysical Logs WRH **96073C**  
Geophysical Logs WRH **96074C**  
Geophysical Logs WRH **96075C**  
Geophysical Logs WRH 960766  
Geophysical Logs WRH **96077C**  
Geophysical Logs WRH **96078C**  
Geophysical Logs WRH 960796  
Geophysical Logs WRH 96080  
Geophysical Logs WRH 96082  
Geophysical Logs WRH 96093  
Geophysical Logs WRH 96094  
Geophysical Logs WRH 96095  
Geophysical Logs WRH 96096  
Geophysical Logs WRH 96097  
Geophysical Logs WRH 96098  
Geophysical Logs WRH 96099  
Geophysical Logs WRH 96100C  
Geophysical Logs WRH 96101  
Geophysical Logs WRH **96102C**  
Geophysical Logs WRH **96103C**  
Geophysical Logs WRH **96104C**  
Geophysical Logs WRH **96105C**  
Geophysical Logs WRH 96106  
Geophysical Logs WRH **96107C**  
Geophysical Logs WRH **96108C**  
Geophysical Logs WRH **96109C**  
Geophysical Logs WRH 961 10C  
Geophysical Logs WRH 9611 1 C  
Geophysical Logs WRH **96112C**  
Geophysical Logs WRH **96113C**  
Geophysical Logs WRH **96114C**  
Geophysical Logs WRH **96115C**





# Big Bad John's Welding

Oilfield • Welding Inspection • B Pressure • 24 Hour Service

Box 1169 • Chetwynd • B.C. • V0C 1J0

**Shop:** (604) 788-4842  
**Phone or Fax:** (604) 788-9761  
**Cellular:** (604) 788-5203  
**Autofel:** (604) 788-0959

**John Johnson**

WRT 96083

*Hole collapsed in deep sand. Too deep for*

*McCaw drill*

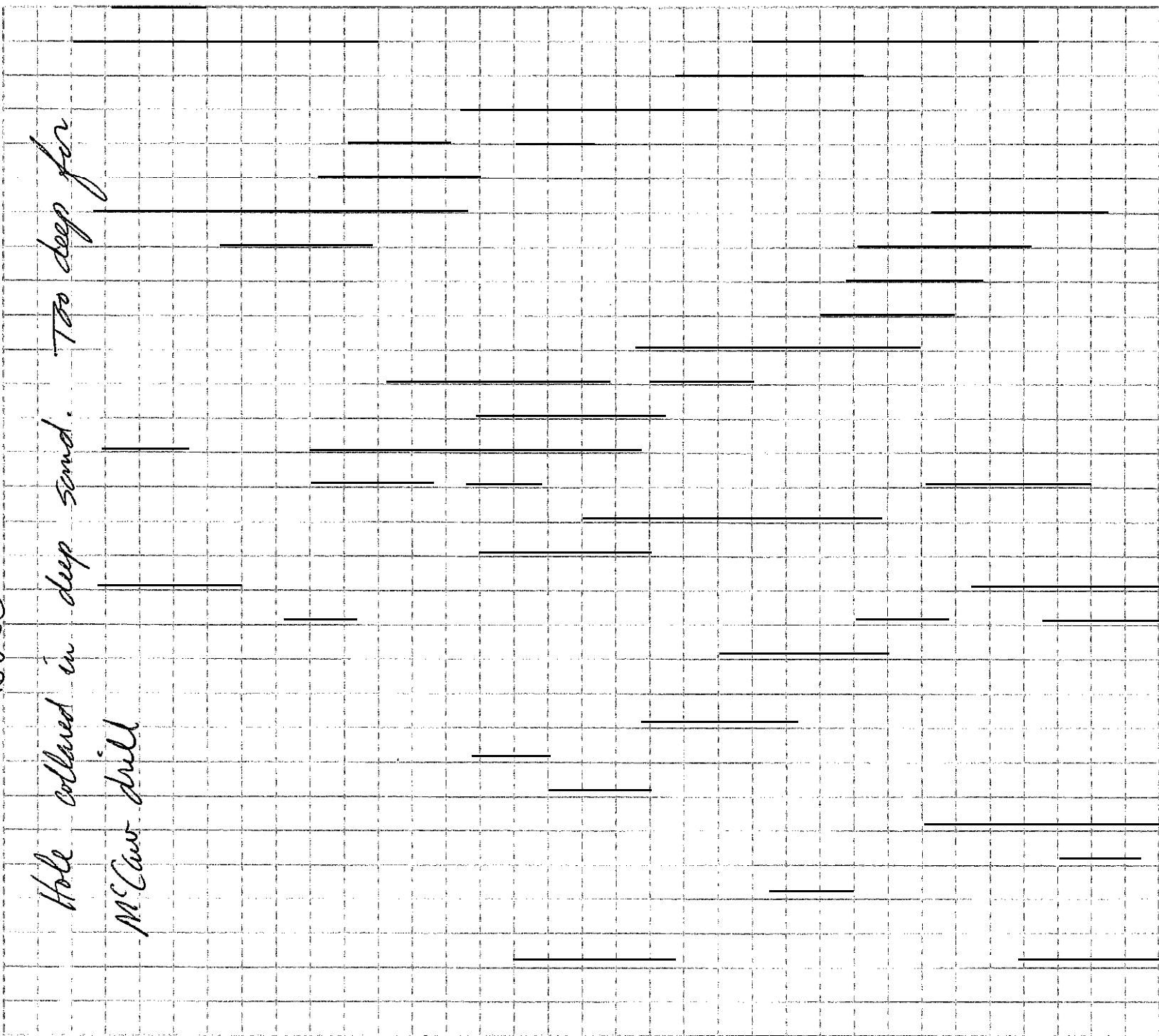



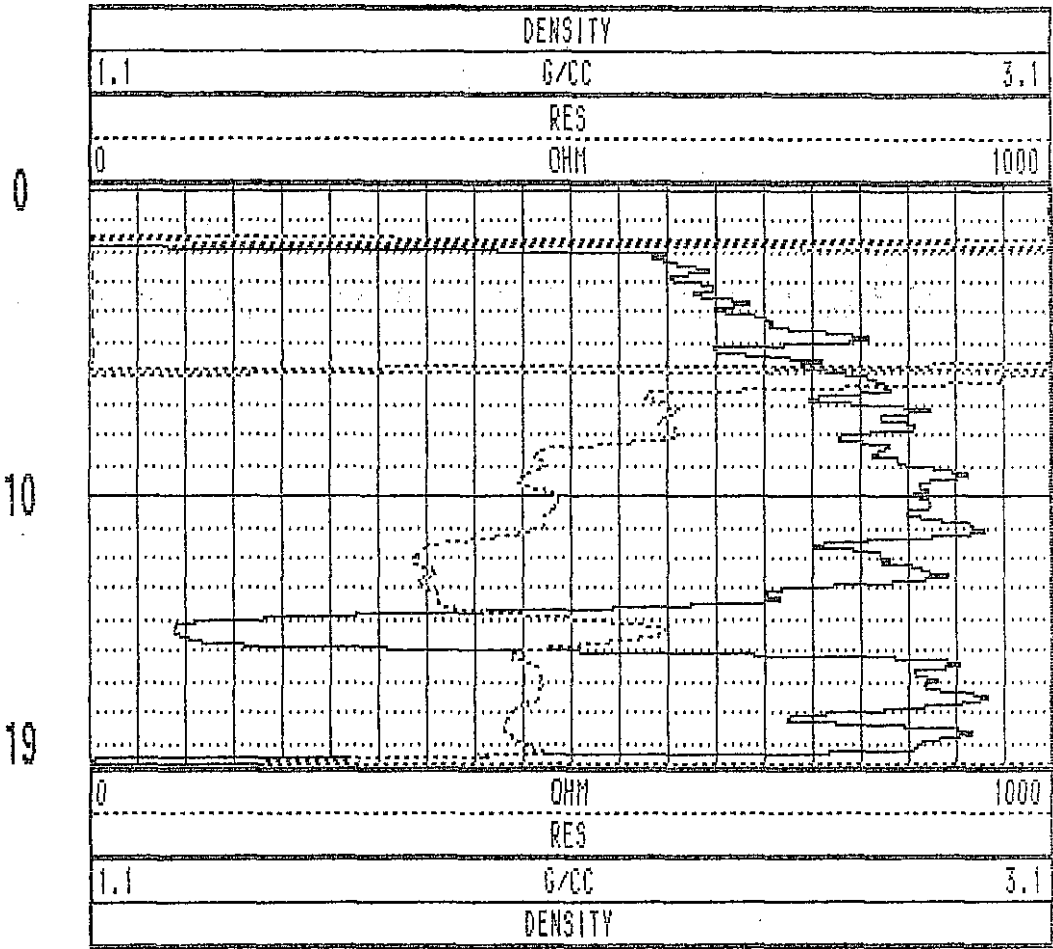
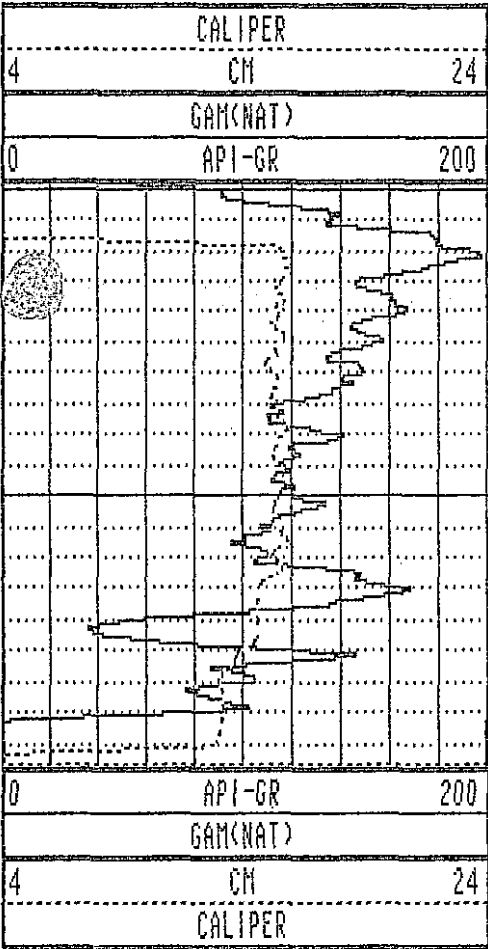

WRH-96104C 08/03/96 958

104 C



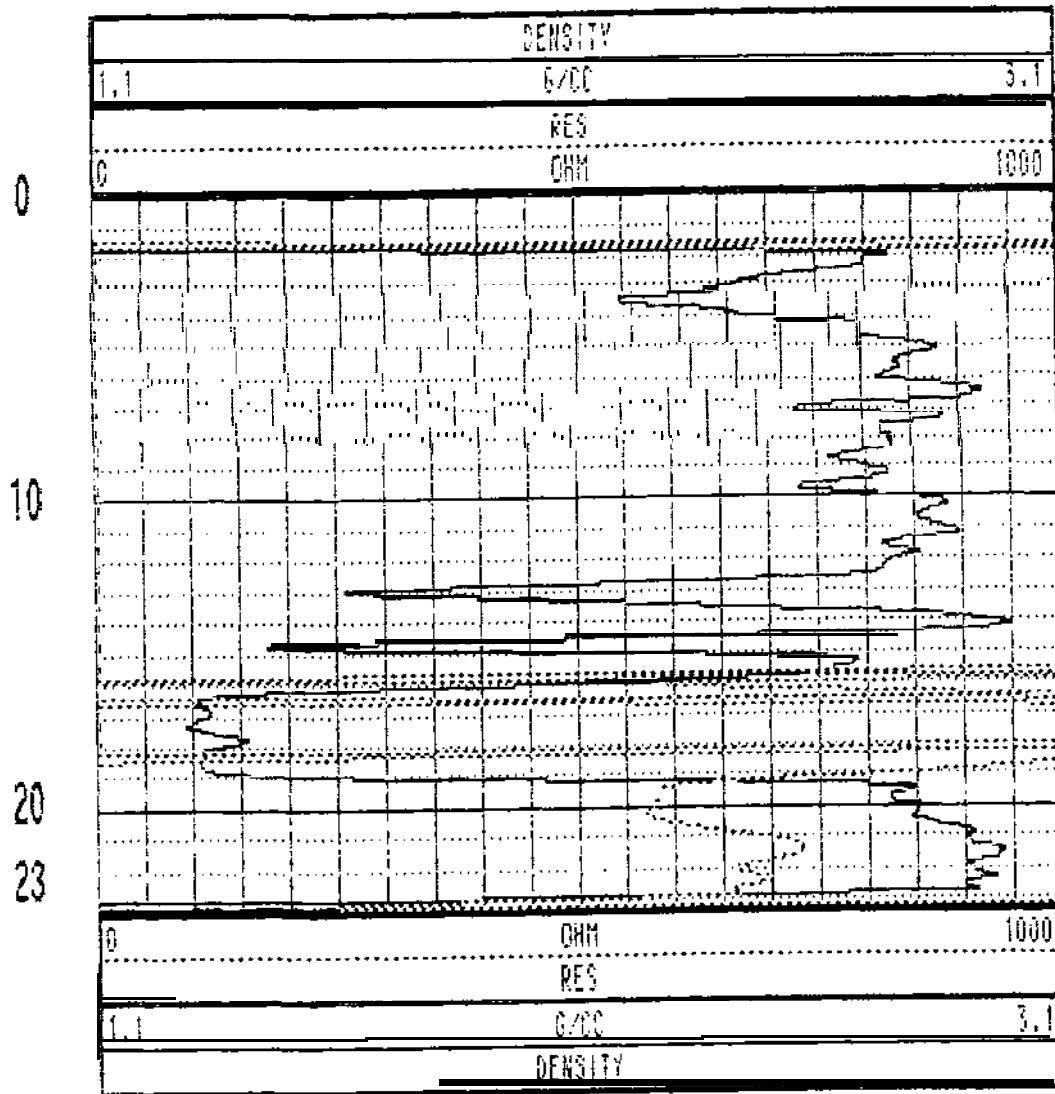
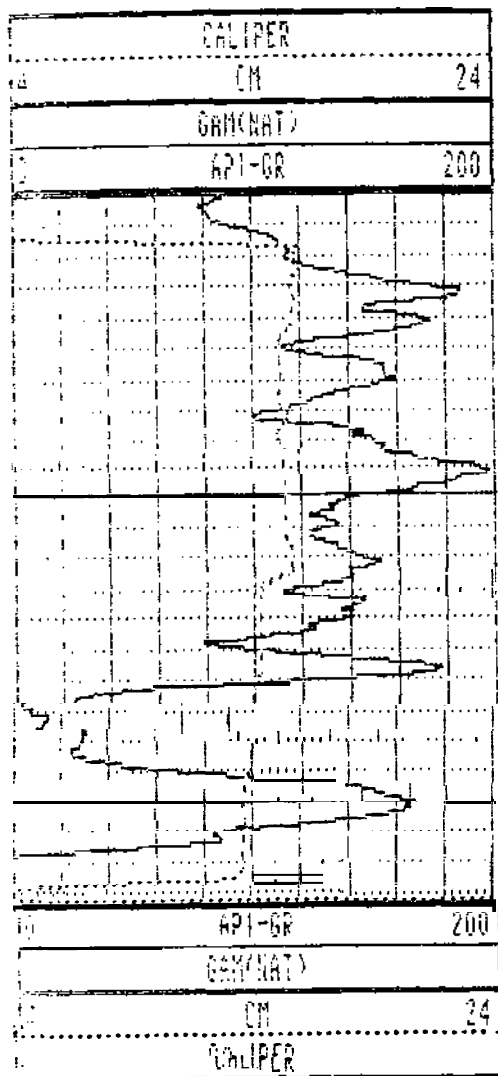

WRH-961100 08/12/96 658

110-C





861



# WILLOW CREEK COAL PROJECT

## 1996 COAL EXPLORATION PROGRAM

PINERIVER AREA  
LIARD MINING DIVISION  
NTS 93 019  
NAD27

Latitude: 55° 36' North  
Longitude: 122° 14' West

Owner :

Pine Valley Coal Ltd.

March 9, 1998

Submitted to :

The Ministry of Energy and Mines

# APPENDIX3

# Geophysical Logs

## Volume 3

Geophysical Logs WRH **96116C**  
Geophysical Logs WRH 96117C  
Geophysical Logs WRH **96118C**  
Geophysical Logs WRH **96119C**  
Geophysical Logs WRH 96120  
Geophysical Logs VVRH 96121  
Geophysical Logs WRH 96122  
Geophysical Logs WRH 96123  
Geophysical Logs WRH 96124  
Geophysical Logs WRH 96125  
Geophysical Logs WRH 96126  
Geophysical Logs WRH 96127  
Geophysical Logs WRH 96128  
Geophysical Logs WRH 96129  
Geophysical Logs WRH 96130  
Geophysical Logs WRH 96131  
Geophysical Logs WRH 96132  
Geophysical Logs WRH 96132A  
Geophysical Logs WRH 96133  
Geophysical Logs WRH 96134  
Geophysical Logs WRH 96135  
Geophysical Logs WRH 96136  
Geophysical Logs WRH 96137  
Geophysical Logs WRH 96137A  
Geophysical Logs WRH 96138  
Geophysical Logs WRH 96139  
Geophysical Logs WRH 96140C  
Geophysical Logs WRH 96141 C  
Geophysical Logs WRH 96142C  
Geophysical Logs WRH 96143  
Geophysical Logs WRH 96144  
Geophysical Logs WRH 96145C  
Geophysical Logs WRH 96146C  
Geophysical Logs WRH 961476  
Geophysical Logs WRH 96148C  
Geophysical Logs WRH 96149C  
Geophysical Logs WRH **96150C**  
Geophysical Logs WRH 96151 C  
Geophysical Logs WRH 96152C  
Geophysical Logs WRH **96153C**  
Geophysical Logs WRH 96154  
Geophysical Logs WRH 96155  
Geophysical Logs WRH 96156  
Geophysical Logs WRH 96157  
Geophysical Logs WRH 96158  
Geophysical Logs WRH 96159  
Geophysical Logs WRH 96160  
Geophysical Logs WRH 96161  
Geophysical Logs WRH 96162  
Geophysical Logs WRH 96163  
Geophysical Logs WRH 96164  
Geophysical Logs WRH 96165

**Volume 3 (cont'd)**

Geophysical Logs WRH 96166  
Geophysical Logs WRH 96167  
Geophysical Logs WRH 96168  
Geophysical Logs WRH 96169  
Geophysical Logs WRH 96169B  
Geophysical Logs WRH 96170  
Geophysical Logs WRH 96171  
Geophysical Logs WRH 96172  
Geophysical Logs WRH **96172A**  
Geophysical Logs WRH 96173  
Geophysical Logs WRH 96174  
Geophysical Logs WRH 96175  
Geophysical Logs WRH 96176  
Geophysical Logs WRH 96176A  
Geophysical Logs WRH 96177  
Geophysical Logs WRH 96178  
Geophysical Logs WRH 96179  
Geophysical Logs WRH 96180



861



# WILLOW CREEK COAL PROJECT

## 1996 COAL EXPLORATION PROGRAM

PINE RIVER AREA  
LIARD MINING DIVISION  
NTS 93019  
NAD 27

Latitude: 55° 36' North  
Longitude: 122° 14' West

Owner :

Pine Valley Coal Ltd.

March 9, 1998

Submitted to :

The Ministry of Energy and Mines

# APPENDIX3

# Geophysical Logs

## Volume 4

Geophysical Logs WRH 96181  
Geophysical Logs WRH 96182  
Geophysical Logs WRH 96183  
Geophysical Logs WRH 96184  
Geophysical Logs WRH 96185  
Geophysical Logs WRH 96186  
Geophysical Logs WRH 96187  
Geophysical Logs WRH 96188  
Geophysical Logs WRH 96189  
Geophysical Logs WRH 96190  
Geophysical Logs WRH 96191  
Geophysical Logs WRH 96192  
Geophysical Logs WRH 96193  
Geophysical Logs WRH 96194  
Geophysical Logs WRH 96195  
Geophysical Logs WRH 96196  
Geophysical Logs WRH 96197  
Geophysical Logs WRH 96198  
Geophysical Logs WRH 96199  
Geophysical Logs WRH 96200C  
Geophysical Logs WRH **96201C**  
Geophysical Logs WRH 96202  
Geophysical Logs WRH 96203  
Geophysical Logs WRH 96204  
Geophysical Logs WRH 96205  
Geophysical Logs WRH **96206C**  
Geophysical Logs WRH **96207C**  
Geophysical Logs WRH 96208  
Geophysical Logs WRH **96209C**  
Geophysical Logs WRH 96210  
Geophysical Logs WRH 96211 C  
Geophysical Logs WRH **96212C**  
Geophysical Logs WRH 96213C  
Geophysical Logs WRH 96214C  
Geophysical Logs WRH **96215C**  
Geophysical Logs WRH 96216C  
Geophysical Logs WRH 96217  
Geophysical Logs WRH 96218  
Geophysical Logs WRH 96219  
Geophysical Logs WRH 96220  
Geophysical Logs WRH 96221  
Geophysical Logs WRH **96221B**  
Geophysical Logs WRH 96222  
Geophysical Logs WRH 96223  
Geophysical Logs WRH 96224  
Geophysical Logs WRH 96225  
Geophysical Logs WRH 96226  
Geophysical Logs WRH 96227  
Geophysical Logs WRH 96228  
Geophysical Logs WRH 96229  
Geophysical Logs WRH 96230  
Geophysical Logs WRH 96231

**Volume 4(cont'd)**

Geophysical Logs WRH 96232  
Geophysical Logs WRH 96233  
Geophysical Logs WRH 96234  
Geophysical Logs WRH 96235  
Geophysical Logs WRH 96236  
Geophysical Logs WRH 96237  
Geophysical Logs WRH 96238  
Geophysical Logs WRH 96243





WRH 96 189  
was not logged  
-the hole collapsed  
after drilling



Hole WRH 96214C was not logged

it was drilled 1 m from WRH 96078C

use the log of ~078C in place of ~214C

sample PV 97586

23.35 - 25.60



WRH 96215C representing ~ 216C

